

Mariani



Listino Prezzi HOME 2020

Price List
Liste de Prix
Preisliste
Lista de Precios

 **Mariani**

INDICE - INDEX

DIVANI - SOFAS

		
ADD LOOK 2	FUSION 58	KOI 98
		
ADD LOOK ROUND 15	GLACE' 63	KRISTALL 103
		
BE LOOK 19	INSULA 72	NIKY 116
		
BRERA 43	JOSHUA 76	SAVILE ROW 138
		
BRIDGE 46	KATE 79	SHANGRI LA 141
		
CHIMERA 51	KEEN 83	TUDOR 145
		
FELLINI 56	KLUB 90	TWIBE 147

CUSCINETTI - LOOSE CUSHIONS

	153
--	-----

TAVOLINI - COFFEE TABLES



ADD LOOK

12



NIKY

125



POT

137



GIOTTO

62



OYSTER

128



SAVILE ROW

139



JOSHUA

77



PAPIER

132



TWIBE

149



KUBICO













107



PARK

134















POLTRONE - ARMCHAIRS

	ALA	36		MANTA	112		SAVILE ROW	138
	BARLEY	37		MARNIE	113		SINGLE	143
	BEVERLY	38		MOORE RELAX	115		TWIBE	147
	BLOB	42		OYSTER	127		UP & DOWN	151
	CASSANDRA	50		OYSTER LIGHT	131		WOODY	152
	GARBO	60		PAPILLON	133			
	HOLLY	71		PLANET	136			

TAVOLI - TABLES

	ASCOT	157		PAPIER	186		WAY	201
	MESH	176		SERA	189		YORK	203
	MOORE	178						

SEDIE - CHAIRS

	BABETTE	159		MARLENE	173		SILHOUETTE	192
	BEVERLY	161		MOORE	178		SISSI	194
	CLAP	163		NANCY	182		TUCROMA	199
	LIV	170		PAPIER	186		VOILE	200
	MAGISTRA	172		SHU	191		WAY	201

CONTENITORI / LIBRERIE - STORAGE UNITS / BOOKCASES

					
BEAT	160	GRID	168	NIKY	184
					
CROSSING	164	LOOP	171	PAPIER	186
					
ELLE	165	MATERICA	174	SERA	189
					
EQUA	167	MOORE	178	SLICK	195

SCRITTOI - WRITING DESKS

					
ARTUR	156	MATERICA	174	NAPA	183

LETTI - BEDS



ADD LOOK

206



JEAN MARIE

209



TUBE

214

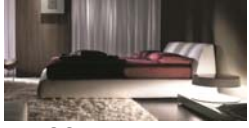

BE LOOK

207



KEEN

212



TUDOR

217



BRERA

208



KRISTALL

213

CONDIZIONI GENERALI DI VENDITA

- **PREZZI:** I prezzi sono in Euro e non comprendono eventuali montaggi o installazioni presso l'acquirente. Il costo netto di un eventuale imballo in cassa di legno sarà pari al 5% del prezzo di listino del prodotto valutato in categoria PF.
- **ORDINI:** La *i 4 Mariani S.p.A.* si riserva di accettare l'ordine; l'ordine verrà accettato solo dopo l'emissione della relativa conferma d'ordine nella quale saranno contenute tutte le condizioni di vendita.
- **TERMINI DI CONSEGNA:** La data di consegna indicata sulla conferma d'ordine, si intende indicativa e nessun risarcimento potrà essere richiesto per eventuali ritardi.
- **TRASPORTI:** *i 4 Mariani S.p.A.* si libera dall'obbligo della consegna rimettendo le merci allo spedizioniere. I prodotti viaggiano ad esclusivo rischio e pericolo dell'acquirente, anche se il trasporto è organizzato da *i 4 Mariani S.p.A.*
Il trasporto è effettuato a spese di *i 4 Mariani S.p.A.* nei seguenti Paesi: Italia, Svizzera, Francia, Austria, Germania, Spagna (isole escluse), Portogallo, Benelux, Gran Bretagna, Irlanda, Danimarca, Norvegia, Svezia e Finlandia. Per tutti gli altri Paesi il trasporto è escluso e quindi il prezzo è da intendersi franco fabbrica (Italia); di conseguenza il costo di trasporto è a carico dell'acquirente.
Nel caso in cui l'ordine abbia un importo netto inferiore a 1.000,00 (mille) Euro, *i 4 Mariani S.p.A.* addebiterà in fattura un costo di trasporto pari ad 100,00 (cento) Euro.
- **RECLAMI:** La merce viene controllata accuratamente prima della spedizione. Eventuali danni vanno riscontrati al momento della consegna, annotati sulla bolla di accompagnamento merci controfirmati dall'autista ed in seguito comunicati nel più breve tempo possibile e in ogni caso non superiore ad otto giorni, alla nostra sede di Mariano Comense.
- **FUORI SERIE:** Per tutti i pezzi fuori serie o su misura, dopo relativa approvazione da parte della nostra organizzazione commerciale, i prezzi subiranno un aumento quantificabile di volta in volta.
- **RIVENDITORI:** In caso di rivendita dei prodotti, è compito dell'acquirente informare i propri clienti in merito alle caratteristiche delle materie prime utilizzate da *i 4 Mariani S.p.A.* ed alle istruzioni d'uso e garanzia. L'acquirente stesso sarà l'unico responsabile nel caso di inosservanza di tali condizioni di utilizzo e manutenzione da parte dei suoi clienti.
- **BRITISH STANDARDS:** I prodotti imbottiti possono essere realizzati secondo le norme BS British Standard con un incremento di prezzo pari al 10% nel caso di rivestimento in tessuto e del 6% in caso di rivestimento in pelle.
- **VALIDITA':** Il presente listino annulla e sostituisce i precedenti. Misure e metraggi del presente listino sono indicativi. La *i 4 Mariani S.p.A.* si riserva di apportare modifiche tecniche, dimensionali o strutturali ai suoi prodotti in qualsiasi momento e senza nessun obbligo di preavviso.
Le tolleranze dimensionali dei prodotti imbottiti sono del $\pm 2\%$.
- **FORO COMPETENTE:** Per qualsiasi controversia Foro competente sarà quello di Como.

GENERAL SALE CONDITIONS

- **PRICES:** The prices are in Euro and don't include any assembly or installation by the buyer. The net price of packing in wooden crate – if required - will be the 5% on the price list of the item evaluated on category PF.
- **ORDERS:** *i 4 Mariani S.p.A.* reserves to accept the order; the order will be accepted only after issue of the confirmation of order, where you will find all sales conditions.
- **DELIVERY TERMS:** The date of the delivery shown on the order confirmation is approximative and no compensation could be required in case of possible delays.
- **TRANSPORTS:** *i 4 Mariani S.p.A.* is freed from the obligation of delivery of the goods consigning them to the carrier. Products will travel exclusively at the Purchaser's risk, even if the transport is organized by *i 4 Mariani S.p.A.*
The transport is carried out at *i 4 Mariani S.p.A.* expenses in the following Countries: Italy, Switzerland, France, Austria, Germany, Spain (except Islands), Portugal, Benelux, Great Britain, Ireland, Denmark, Norway, Sweden and Finland. For all other countries, transport is excluded and therefore the price is ex works (Italy); therefore the shipping cost is paid by the buyer.
In case the order has a net worth less than 1,000.00 (one thousand) Euros, *i 4 Mariani S.p.A.* will charge on the invoice a transport cost equal to 100.00 (one hundred) Euro.
- **COMPLAINTS:** The goods is carefully checked before shipment. Possible damages must be compared during delivery, noted on the bill of lading countersigned by the driver and then you have to inform our factory in Mariano Comense as soon as possible and not later than 8 days.
- **CUSTOM BUILT:** For all the special pieces out of standard production or on special size, after approval from our commercial organization, the prices will have an increase estimated time by time.
- **RETAILERS:** In case of resale of the products, it is buyer's responsibility to inform their customers about the characteristics of the raw materials used by *i 4 Mariani S.p.A.* and of the guarantee instructions. The buyer himself will be solely responsible in the event of breach of those conditions of use and maintenance by its customers.
- **BRITISH STANDARDS:** The upholstered items can be manufactured according to British Standard BS with a price increase of 10% in case of fabric upholstery and 6% in case of leather upholstery.
- **VALIDITY:** The existing price list cancels and replaces the previous one. Sizes and lengths of the following price list are indicative. *i 4 Mariani S.p.A.* reserves to bring technical, dimensional or structural modifications to the products in any moment and without any obligation of notice.
The dimensional tolerances of upholstered items are of $\pm 2\%$.
- **COMPETENT COURT:** For any disagreement competent court will be the one in Como (Italy).

CONDITIONS GÉNÉRALES DE VENTE

- **PRIX:** Les prix sont au public et en Euro et ils ne comprennent pas le montage ou l'installation éventuelle chez l'acheteur. Le coût net d'emballage avec caisse de bois est 5% du prix brut de list de l'article en categorie PF.
- **COMMANDES:** La société *i 4 Mariani S.p.A.* se réserve d'accepter la commande. La commande sera acceptée uniquement après l'émission de la confirmation de commande y rélatve qui contiendra toutes les conditions de vente.
- **DÉLAIS DE LIVRAISON:** La date de livraison indiquée sur la confirmation de commande est à titre indicatif et aucune indemnisation ne pourra être demandée pour des retards éventuels.
- **TRANSPORT:** La société *i 4 Mariani S.p.A.* est libérée de l'obligation de la livraison en remettant la marchandise au transporteur. Les produits voyagent aux risques et périls de l'acheteur, même si le transport est organisé par *i 4 Mariani S.p.A.*
Le transport est effectué à la charge de *i 4 Mariani S.p.A.* dans les Pays suivants: Italie, Suisse, France, Autriche, Allemagne, Espagne (sauf îles), Portugal, Benelux, Grande-Bretagne, Irlande, Danemark, Norvège, Suède et Finlande. Pour tous les autres Pays, le transport est exclu et donc le prix est à considérer départ usine, Ex Works (Italie); donc le coût d'expédition est payé par l'acheteur.
Dans le cas où la commande a une valeur nette inférieure à 1.000,00 (mille) Euros, *i 4 Mariani S.p.A.* chargera sur la facture un coût de transport de 100,00 (cent) Euros.
- **RÉCLAMATIONS:** La marchandise est contrôlée soigneusement avant d'être expédiée. Les dégâts éventuels doivent être relevés au moment de la livraison, indiqués sur le bon de livraison et contresignés par le chauffeur. Ensuite ils doivent être signalés à notre siège à Mariano Comense dans le plus court délai possible et en tout cas dans une période inférieure à huit jours.
- **HORS SÉRIE:** Pours les éléments hors série ou sur mesure, qui devront toujours avoir l'approbation de notre organisation commerciale, les prix subiront une augmentation qui sera quantifiée à chaque fois.
- **DÉTAILLANTS:** Dans le cas de revente des produits, il est responsabilité de l'acheteur d'informer ses clients concernant les caractéristiques des matières premières utilisées par *i 4 Mariani S.p.A.* et concernant le mode d'emploi et d'entretien. L'acheteur lui-même sera le seul responsable en cas de inobservance de ces conditions d'utilisation et d'entretien de la part de ses clients.
- **BRITISH STANDARDS:** Les produits rembourrés peuvent être fabriqués selon les normes BS British Standard avec une augmentation de prix de 10% dans le cas de revêtement en tissu et de 6% dans le cas de revêtement en cuir.
- **VALIDITÉ:** Ce tarif annule et remplace les précédents. Dimensions et métrages de tissu sur ce tarif sont à titre indicatif. La société *i 4 Mariani S.p.A.* se reserve d'apporter des modifications techniques, des dimensions ou structurelles à ses produits à n'importe quel moment et sans devoir de préavis. Les tolérances de dimension des produits rembourrés sont de $\pm 2\%$.
- **TRIBUNAL COMPÉTENT:** Pour tout litige le Tribunal compétent sera celui de Como (Italie).



ALLGEMEINE GESCHAEFTSBEDINGUNGEN

- **PREISE:** Die Preise sind Verkaufspreise in Euro ausschliesslich der Kosten fuer Montage und Installation durch den Kaeufer. Die Nettokosten von Holzkisten Verpackung sind 5% der Brutto Preisliste des Artickels in der PF Kategorie.
- **AUFTRAEGE:** *i 4 Mariani S.p.A.* behaelt sich die Annahme eines Auftrags vor. Der Auftrag kommt erst nach dem Erhalt der Auftragbestaetigung zustande, auf der alle Verkaufsbedingungen enthalten sind.
- **LIEFERTERMINE:** Die auf der Auftragbestaetigung genannte Lieferzeit ist nicht verbindlich und kann abweichen. Eine Verspaetung begruedet keinen Schadenersatzanspruch.
- **TRANSPORT:** *i 4 Mariani S.p.A.* ist von der Verpflichtung zur Umsetzung über die Ware an die Reederei befreit. Die Produkte werden auf Risiko und Gefahr des "Käufers geliefert, auch wenn der Transport durch die *i 4 Mariani S.p.A.* organisiert ist.
Italien, Schweiz, Frankreich, Österreich, Deutschland, Spanien (außer Inseln), Portugal, Benelux, Großbritannien , Irland, Dänemark, Norwegen, Schweden und Finnland: Der Transport wird in den *i 4 Mariani S.p.A.* Aufwendungen in den folgenden Ländern durchgeführt . Für alle anderen Länder ist, der Beförderung ausgeschlossen und deshalb ist der Preis ab Werk (Italien); daher die Versandkosten sind vom Käufer zu tragen.
Wenn der Auftrag einen netti Wert weniger als 1000,00 (eintausend) € hat, wird die Firma *i 4 Mariani S.p.A.* 100,00 (hundert) € als Ttransportkosten in der Rechnung berechnen.
- **REKLAMATION:** Die Ware wird vor Verlassen des Werks genau kontrolliert. Eventuelle Schaeden muessen sofort bei Empfang der Ware festgestellt und auf dem Lieferschein vermerkt werden, versehen mit einer Bestaetigung des Spediteur oder dessen Fahrer. Die Benachrichtung an *i 4 Mariani S.p.A.* in Mariano Comense muss unverzueglich innerhalb von 8 Tagen erfolgen.
- **SONDERANFERTIGUNG:** Sonderanfertigungen und Sondermasse sind nur nach vorheriger Absprache mit *i 4 Mariani S.p.A.* moeglich. Sie bedingen in jedem Fall einen Mehrpreis.
- **VERKAUFSTELLEN:** Wenn es ein Weiterverkauf der Produkte gibt, wird der Käufer seine Kunden über die Eigenschaften der Rohstoffe von *i 4 Mariani S.p.A.* und Gebrauchsanweisungen und Gewhaerleistungen informieren. Der Käufer wird im Falle einer Verletzung dieser Nutzungsbedingungen und der Wartung durch den Kunden selbst verantwortlich.
- **BRITISH STANDARDS:** Die Polsterprodukte können mit einem Preisanstieg von 10% im Falle von Stoffbespannung und 6% im Fall von Lederpolster nach British Standard BS-Standards hergestellt werden.
- **GULTIKKEIT:** Mit Erscheinen dieser Preisliste werden alle Vorhergegangenen ungueltig. Masse sind Angaben. Die Firma *i 4 Mariani S.p.A.* behaelt sich vor, jerderzeit technische, massliche oder strukturelle Veraenderungen ihrer Produkte vorzunehmen, ohne voerherige Benachrichtigung. Die Maßtoleranzen von Polster Produkte sind von $\pm 2\%$.
- **GERICHTSSTAND:** Gerichtsstand fuer alle Streitigkeiten ist immer Como(Italien).

CONDICIONES GENERALES DE VENTA

- **PRECIOS:** Los precios son en Euros y no incluyen eventuales montajes o instalaciones en el domicilio del cliente. El coste neto para eventual embalaje en caja de madera será equivalente al 5% del precio del producto interesado valorado en la categoría PF.
- **PEDIDOS:** La empresa *i 4 Mariani S.p.A.*, se reserva el derecho de aceptar el pedido y el mismo será aprobado solo después de la emisión de la confirmación del pedido por escrito, con todas las condiciones de venta.
- **FECHA DE ENTREGA:** La fecha de entrega indicada en el documento de venta es sólo indicativa y no se puede pedir ningún resarcimiento de daños debido a eventuales retrasos.
- **TRANSPORTE:** *i 4 Mariani S.p.A.* es liberado de la obligación de poner a cargo de la mercancía al vehículo. Los productos se transportan a riesgo y peligro del comprador, incluso si el transporte es organizado por *i 4 Mariani S.p.A.*
El transporte se realiza a gastos de parte de *i 4 Mariani S.p.A.* en los siguientes Países: Italia, Suiza, Francia, Austria, Alemania, España (excepto Islas), Portugal, Benelux, Gran Bretaña, Irlanda, Dinamarca, Noruega, Suecia y Finlandia. Para todos los demás Países, se excluye el transporte y, por tanto, el precio es franco fábrica (Italia); por lo tanto, el costo del transporte es pagado por el comprador.
En caso de que la orden tiene un valor neto de menos de 1.000,00 (mil) Euros, *i 4 Mariani S.p.A.* cargará en la factura un coste de transporte igual a 100.00 (cien) Euros.
- **RECLAMACIÓN:** Toda la mercancía pasa un control de calidad antes de la carga. Por lo tanto, para eventuales daños hay que reclamarlos durante la entrega, firmar el documento y después en un plazo máximo de 8 días comunicar el problema a nuestra oficina situada en Mariano Comense.
- **MEDIDAS ESPECIALES:** Los precios de todos los modelos con medidas especiales, deben ser cotizados cada vez.
- **PUNTOS DE VENTA:** En el caso de reventa de los productos, es responsabilidad del comprador informar a sus clientes sobre las características de las materias primas utilizadas por la *i 4 Mariani S.p.A.* y sobre las instrucciones de garantía. El propio comprador será el único responsable en caso de incumplimiento de estas condiciones de uso y mantenimiento de sus clientes.
- **BRITISH STANDARDS:** Los productos tapizados pueden ser fabricados de acuerdo a las normas BS British Standard con un aumento de precios del 10% en el caso de revestimiento de tejido y el 6% en el caso de revestimiento de cuero.
- **VALIDEZ:** Este listín anula y reemplaza los precedentes. Las medidas y los metrajés son puramente indicativos. La empresa *i 4 Mariani S.p.A.*, puede modificar técnicamente los productos sin previo aviso. Las tolerancias dimensionales de los productos tapizados son de $\pm 2\%$.
- **FORO COMPETENTE:** Para cualquier controversia, el tribunal competente es el de Como (Italia).

LEGENDA - NOTE - LÉGENDE – LEGENDE - NOTA

	Codice aziendale Firm reference Code d'entreprise Betriebsreferenz Referencia de impresa	Descrizione Description Description Beschreibung Descripción	
	UPDOWNDIVANET	I Divanetto trasformabile in chaise longue tramite motore elettrico. E Sofa that can be changed into chaiselongue by an electric motor. F Canapé qui peut se transformer en chaise longue grâce à un moteur électrique. D Verwandeln Sofa in einem Chaise-longue durch elektrischen Motor. S Sofá convertible en chaiselongue por medio de motor eléctrico.	COM 4.191,00 L 4.327,00 T 4.490,00 S 4.625,00 Z 4.787,00 K 4.923,00 PS 5.334,00 PF 5.801,00 PX 6.820,00 PA 7.591,00
			
cm. 160/199 x 96 x h 73/104 – hs 44 • mt. 6.25			
Dimensione di ingombro in cm. LxPxh (L=Larghezza; P=Profondità; h=Altezza totale; hs=Altezza seduta) Dimensions in cm. LxPxh (L=Width; P=Depth; h=Height; hs=Height of sitting) Dimensions en cm. LxPxh (L=Largeur; P=Profondeur; h=Hauteur; hs=Hauteur de l'assise) Aussenmasse in cm. LxPxh (L=Breite; P=Tiefe; h=Hohe; hs=Hohe vom Sitzung) Dimensiones externas LxPxh (L=ancho; P= profundidad; h=altura total; hs=altura del asiento)			Categorie e Prezzi Categories and Prices Catégories et Prix Kategorien und Preise Categorias y precios
		Metraggio di tessuto necessario per il confezionamento del rivestimento (altezza del tessuto cm. 140) Length of fabric needed for the manufacture of the upholstery (height of the fabric cm. 140) Métrage de tissu nécessaire pour confectionner le revêtement (laize cm. 140) Metermessung von Stoff nötig für Anfertigung der Bezug (Höhe vom Stoff cm. 140) Metraje de tejido que necesita para tapizar (altura del tejido cm 140)	

CATEGORIE DEI RIVESTIMENTI - CATEGORIES OF COVERS - CATÉGORIES DES REVÊTEMENTS
KATEGORIEN VON BEZÜGE - CATEGORÍAS DE LOS TAPIZADOS

TESSUTI – FABRICS – TISSUS – STOFFEN – TEJIDOS

COM Tessuto fornito dal Cliente
 Customer's own material
 Tissu fourni par le Client
 Stoffe von Kunde
 Tela Cliente

L/T/S/Z/K Tessuto di nostra Collezione
 Material of our Collection
 Tissu de notre Collection
 Stoffe aus unserer Kollektion
 Tejido nuestra colección

CUOI – SADDLE LEATHERS – CUIRS ÉPAIS – RINDLEDER – CUEROS

CS Cuoietto
 Saddle Leather
 Cuir Épais
 Rindleder
 Cuero

CF Cuoio Pieno Fiore
 Full Grain Saddle Leather
 Cuir Épais Pleine Fleur
 Kalbrindleder
 Cuero Plena Flor

CV Cuoio pieno fiore conciato al Vegetale
 Vegetable tanned full grain Saddle Leather
 Cuir Épais pleine fleur tanné végétal
 Vegetabile gegerbttes Kalbrindleder
 Cuero Plena Flor curtido vegetal

PELLI – LEATHERS – CUIRS – LEDER – PIEL

PS Pelle Mezzo Fiore
 Half grain Leather
 Cuir Souple Demie Fleur
 Half Grain Leder
 Piel Media Flor

PF Pelle Fiore
 Full Grain Leather
 Cuir Fleur
 Kalbleder
 Piel Flor

PX Pelle Extra
 Leather Extra
 Cuir Extra
 Leder Extra
 Piel de calidad extra

PA Pelle Atelier
 Leather Atelier
 Cuir Atelier
 Leder Atelier
 Piel Atelier

La categoria da applicare nel caso di pelle fornita dal Cliente è la **K**.
 In case of Customer's own leather the category to apply is **K**.
 Si on doit réaliser le modele avec cuir fourni par le Client la catégorie a appliquer est la **K**.
 Wenn Kunde liefern das Leder direkt an uns, die Preiskategorie ist **K**.
 Si el cliente envía la piel, hay que usar el precio de la categoría **K**.

CARATTERISTICHE E AVVERTENZE

- **TESSUTI:** E' possibile che i tessuti nelle varie categorie possano presentare delle leggere variazioni di tonalità di colore da una partita all'altra. Tali differenze di tonalità rientrano nelle tolleranze e quindi non imputabili alla *i 4 Mariani S.p.A.*; di conseguenza non potranno dar luogo a richieste di sostituzioni o danni. E' vostro diritto comunque richiedere dei campioni dallo stock.

Nel caso in cui venga effettuato un ordine con tessuti appartenenti a diverse categorie, il prezzo da applicare è quello della categoria più alta.

I tessuti di proprietà del cliente – categoria COM – che dovranno essere utilizzati per confezionare il rivestimento di uno dei nostri modelli, devono essere consegnati in porto franco, altrimenti verranno rispediti al mittente. Su questi tessuti dovrà inoltre essere riportata chiaramente l'indicazione circa il **diritto ed il rovescio e l'alto ed il basso** del tessuto stesso onde evitare spiacevoli errori nel confezionamento.

- **PELLI E CUOIO:** E' possibile che le pelli ed il cuoio nelle diverse varie categorie possano presentare delle leggere variazioni di tonalità di colore da una partita all'altra. Tali differenze di tonalità rientrano nelle tolleranze e quindi non imputabili alla *i 4 Mariani S.p.A.*; di conseguenza non potranno dar luogo a richieste di sostituzioni o danni. E' vostro diritto comunque richiedere dei campioni dallo stock.

Le concerie incaricate dalla *i 4 Mariani S.p.A.* selezionano solo ed esclusivamente il miglior pellame bovino da tutta Europa che è sottoposto ad opportuni trattamenti di concia (al cromo per la pelle e mista al cromo-vegetale per il cuoio) e di tinta, passante su tutto lo spessore, secondo i colori atossici della nostra collezione. Tutte le pelli ed il cuoio della collezione non contengono PentaCloroFenolo.

CUOI

CV – Cuoio Vegetale: Cuoio pieno fiore conciato al vegetale con spessore di 3,2÷3,4 mm. Rifinitura all'anilina.

CF – Cuoio Pieno Fiore: Cuoio pieno fiore dello spessore di 3,0÷3,2 mm.

CS – Cuoietto: Cuoio dello spessore di 2,4÷2,5 mm.

PELLI

PA – Pelle Atelier: Pelle bovina a pieno fiore con spessore variabile da 1,0 a 1,5 mm. Le diverse tipologie di pelli appartenenti a questa categoria subiscono dei trattamenti molto pregiati tutti a base di anilina.

PX – Pelle Extra: Pelle bovina a pieno fiore con spessore variabile da 1,3 a 2,0 mm. Le diverse tipologie di pelli appartenenti a questa categoria subiscono dei trattamenti molto pregiati tutti a base di anilina.

PF – Pelle Fiore: Pelle bovina pieno fiore dello spessore di 1,2÷1,4 mm.

PS – Pelle Mezzo Fiore: Pelle bovina mezzo fiore dello spessore di 0,9÷1,1 mm.

ATTENZIONE

Particolare attenzione deve essere fatta per le pelli appartenenti alle seguenti categorie:

CV – Cuoio Vegetale

PA – Pelle Atelier

PX – Pelle Extra

Le diverse tipologie di pelli appartenenti a queste categoria subiscono dei trattamenti molto pregiati tutti a base di anilina. Questi trattamenti conferiscono ad ogni singola pelle delle finiture superficiali e delle tonalità di colore molto variabili; è quindi possibile che vi siano delle differenze sensibili di finitura e colore anche in punti diversi dello stesso prodotto finito. Per queste ragioni **non sarà mai accettato per nessun motivo alcun reclamo** relativo alla variabilità della finitura superficiale e della colorazione.

Proprio perchè prive di qualsiasi trattamento protettivo della superficie, queste pelli sono veramente molto delicate e necessitano di grande cure ed attenzione:

- nel caso di macchie da liquidi occorre asciugare immediatamente prima che il prodotto penetri all'interno lasciando macchie indelebili;
- evitare la luce diretta del sole, pena lo sbiadire del colore;
- evitare l'esposizione diretta a fonti di calore.

- **ESSENZE:** Nella realizzazione di alcuni prodotti vengono utilizzate impiallaccature (lastra spessore mm.0,8) e bordi impiallacciati (spessore mm. 1÷2) delle seguenti essenze legnose:

- **Ebano Macassar** (*Diospyros celebica*): peso specifico 1.100 kg/mc.
- **Eucalipto** (*Eucalyptus rostrata*): peso specifico 820÷850 kg/mc
- **Lati** (*Amphimas ferrugineus o pterocarpoides*): peso specifico 500 kg/mc.
- **Noce** (*Juglans Regia*): peso specifico 600 kg/mc (*con finitura noce biondo rigato*).
- **Noce canaletto** (*Juglans nigra*): peso specifico 650÷700 kg/mc.
- **Zebrano** (*Microberlinia brazzavillensis*): peso specifico 500÷800 kg/mc.
- **Tipo Ebano** (*Essenza di Ayous - Triplochiton scleroxylon*): peso specifico 420 kg/mc.
- **Tipo Palissandro** (*Essenza di Ayous - Triplochiton scleroxylon*): peso specifico 420 kg/mc.
- **Tipo Rovere** (*Essenza di Ayous - Triplochiton scleroxylon*): peso specifico 420 kg/mc (*con finitura rovere naturale o rovere moro*).

La lucidatura standard è di tipo opaco (5÷20 gloss) ed è realizzata con vernici poliuretatiche secondo le norme vigenti.

Tutti i prodotti posso essere realizzati anche con lucidatura con finitura lucida spazzolata hi-gloss (100 gloss). **In tal caso il supplemento di prezzo è pari al + 20%.**

GENERAL WARNINGS

- **FABRICS:** It is possible that the fabrics in the various categories can have some light differences of the colour tone from one dye to another. These differences of colour tone come back in the tolerances and therefore not imputable to *i 4 Mariani S.p.A.* consequently it is not possible to ask for replacements or damages. It is your right to ask for samples from stock. In case that an order is placed with fabrics belonging to different categories, it must be applied the price of the highest category.

The customer own fabrics – our category COM – which should be used for the covering of one of our model, must be delivered free port, otherwise they will be sent back to the sender. On these fabrics should be also noted clearly the indication about **the right and the back, the wide and the narrow** of the fabric in order to avoid unpleasant setbacks and inconveniences in the manufacturing.

- **LEATHERS AND SADDLE LEATHER:** It is possible that the leathers in the various categories can have some light differences of the colour tone from one dye to another. These differences of colour tone come back in the tolerances and therefore not imputable to *i 4 Mariani S.p.A.* consequently it is not possible to ask for replacements or damages. It is your right to ask for samples from stock.

The tanneries instructed by *i 4 Mariani S.p.A.* choose only exclusively the best cowhide from all Europe that is submitted to suitable treatments of chrome tanning and colour on all the thickness of the leather. The leather is dyed with non-toxic colours. All the leathers in the collection are free from pentachlorophenol.

SADDLE LEATHERS

CV – Cuoio Vegetale: Cow full grain saddle leather vegetable tanned with thickness 3,2÷3,4 mm. Finishing with aniline.

CF – Cuoio Pieno Fiore: Cow full grain saddle leather thickness 3,0÷3,2 mm.

CS – Cuoietto: Cow saddle leather thickness 2,4÷2,5 mm.

LEATHERS

PA – Pelle Atelier: Cow full grain leather with different thickness from 1,0 to 1,5 mm. All the different leathers of this category are submitted to very special and precious processes with aniline.

PX – Pelle Extra: Cow full grain leather with different thickness from 1,3 to 2,2 mm. All the different leathers of this category are submitted to very special and precious processes with aniline.

PF – Pelle Fiore: Cow full grain leather thickness 1,2÷1,4 mm.

PS – Pelle Mezzo Fiore: Cow half grain leather with thickness of 0,9÷1,1 mm.

ATTENTION

Particular attention must be paid to leathers belonging to the following categories:

CV – Cuoio Vegetale

PA – Pelle Atelier

PX – Pelle Extra

These treatments give to every single skin some superficial effects and colour tonalities that are different from skin to skin; therefore there could be different superficial effects and colour tonalities also on the same finished product. For this reason **we will never accept any claim** relative to the variability of the superficial effects or colours.

Because these leathers are not treated with any superficial covering agents, they are very delicate and need great care and attention:

- in the event of liquid spills, they need to be dried immediately before the liquid infiltrates the material and leave indelible stains;
- avoid placing leather in direct sunlight, in order to avoid colour fading;
- keep away the leather from direct heat sources.

- **KIND OF WOOD:** For the production of some executive models we use veneers (slab thick mm.0,8) and edges (thickness mm. 1÷2) of the following kinds of wood:

- **Macassar Ebony wood** (*Diospyros celebica*): specific weight 1.100 kg/mc.
- **Eucalyptus** (*Eucalyptus rostrata*): specific weight 820÷850 kg/mc.
- **Lati wood** (*Amphimas ferrugineus o pterocarpoides*): specific weight 500 kg/mc.
- **Walnut wood** (*Juglans Regia*): specific weight 600 kg/mc (*Striped blonde walnut finish*).
- **Black walnut wood** (*Juglans nigra*): specific weight 650÷700 kg/mc.
- **Zebran wood** (*Microberlinia brazzavillensis*): specific weight 500÷800 kg/mc.
- **Ebony type** (*Ayous wood - Triplochiton scleroxylon*): specific weight 420 kg/mc.
- **Rosewood type** (*Ayous wood - Triplochiton scleroxylon*): specific weight 420 kg/mc.
- **Oak type** (*Ayous wood - Triplochiton scleroxylon*): specific weight 420 kg/mc (*Natural oak or dark brown oak finish*)

The standard polishing is matt (5÷20 gloss) and is made with polyurethane coatings according to applicable regulations.

All products can also be made with polishing with a brushed glossy finish hi-gloss (100 gloss). **In this case, the price surcharge to apply is + 20%.**

CARACTÉRISTIQUES ET INSTRUCTIONS

- **TISSUS:** Tous les tissus, dans les différentes catégories, peuvent présenter des légères différences de ton d'un stock à l'autre. Ces différences, qui rentrent dans les tolérances, ne sont pas imputables à la société *i 4 Mariani S.p.A.*, par conséquent elles ne pourront pas donner lieu à demandes pour remplacements ou indemnités. Vous avez quand même le droit de demander des échantillons de tissu pris du stock.

Si l'article est à réaliser avec des tissus qui appartiennent à des catégories différentes, il faut appliquer le prix de la catégorie supérieure.

Les tissus envoyés par le client – catégorie COM – qui devront être utilisés pour confectionner le revêtement d'un de nos articles, seront à nous livrer Franco, en cas contraire ils seront retournés à l'expéditeur. Sur ces tissus il faudra indiquer clairement **endroit et envers, haut et bas** du tissu pour éviter des erreurs au moment de la confection.

- **CUIRS:** Tous les cuirs, dans les différentes catégories, peuvent présenter des légères différences de ton d'un stock à l'autre. Ces différences, qui rentrent dans les tolérances, ne sont pas imputables à la société *i 4 Mariani S.p.A.*, par conséquent elles ne pourront pas donner lieu à demandes pour remplacements ou indemnités. Vous avez quand même le droit de demander des échantillons de cuir pris du stock.

Les tanneries chargées par la société *i 4 Mariani S.p.A.* ne sélectionnent que les meilleures peaux bovines de toute l'Europe qui sont soumises aux traitements opportuns de tannage (au chrome pour les cuirs catégorie PP, PF, TC et au chrome-végétal pour la catégorie C) et de teinture pénétrante dans toute l'épaisseur de la peau, selon les couleurs atoxiques de notre collection. Tous les cuirs de notre collection ne contiennent pas de pentachlorephénole.

CUIR ÉPAIS

CV – Cuoio Vegetale: Cuir épais pleine fleur tanné végétal avec épaisseur 3,2 ÷ 3,4 mm. Finition à l'aniline.

CF – Cuoio Pieno Fiore: Cuir épais pleine fleur, épaisseur 3,0 ÷ 3,2 mm.

CS – Cuoietto: Cuir épais, épaisseur 2,4 ÷ 2,5 mm.

CUIR SOUPLE

PA – Pelle Atelier: Cuir souple bovin pleine fleur avec épaisseur variable entre 1,0 et 1,5 mm. Les différents cuirs qui appartiennent à cette catégorie ont subi des traitements très précieux, tous à base d'aniline.

PX – Pelle Extra: Cuir souple bovin pleine fleur avec épaisseur variable entre 1,3 et 2,0 mm. Les différents cuirs qui appartiennent à cette catégorie ont subi des traitements très précieux, tous à base d'aniline.

PF – Pelle Fiore: Cuir souple bovin pleine fleur avec épaisseur 1,2÷1,4 mm.

PS – Pelle Mezzo Fiore: Cuir souple bovin demie fleur avec épaisseur cm. 0,9÷1,1 mm.

ATTENTION

Une attention particulière doit être portée aux cuirs appartenant aux catégories suivantes:

CV – Cuoio Vegetale

PA – Pelle Atelier

PX – Pelle Extra

Ces traitements donnent à chaque peau des finitions superficielles et des nuances de couleur très variables, qui peuvent être notées sur le même article ou produit aussi. Pour cette raison **nous ne pourrions pas accepter aucune réclamation** concernant la variabilité de la finition superficielle et de la coloration.

Etant donné qu'ils sont sans traitement protecteur sur la surface, ces cuirs sont vraiment très délicats et nécessitent d'un grand soin et d'attention:

- En cas de taches de liquides il faut les essuyer immédiatement avant que le produit puisse pénétrer à l'intérieur et laisser des taches indélébiles.
- Eviter la lumière directe du soleil sous peine de les décolorer.
- Eviter l'exposition directe à des sources de chaleur.

- **BOIS:** Des placages (plaque de bois épaisseur mm. 0,8) et des bordures (épaisseur mm. 1÷2) sont utilisés pour quelques modèles de direction, selon le détail suivant:

- **Ébène Macassar** (*Diospyros celebica*): poids spécifique 1.100 kg/mc.
- **Eucalyptus** (*Eucalyptus rostrata*): poids spécifique 820÷850 kg/mc.
- **Lati** (*Amphimas ferrugineus o pterocarpoides*): poids spécifique 500 kg/mc.
- **Noyer** (*Juglans*): poids spécifique 600 kg/mc (*avec finition noyer blond avec rayures*).
- **Noyer d'Amérique** (*Juglans nigra*): poids spécifique 650÷700 kg/mc.
- **Zebrano** (*Microberlinia brazzavillensis*): poids spécifique 500÷800 kg/mc.
- **Bois comme ébène** (*Bois de Ayous - Triplochiton scleroxylon*): poids spécifique 420 kg/mc.
- **Bois comme palissandre** (*Bois de Ayous - Triplochiton scleroxylon*): poids spécifique 420 kg/mc.
- **Bois comme rouvre** (*Bois de Ayous - Triplochiton scleroxylon*): poids spécifique 420 kg/mc. (*avec finition rouvre naturel ou rouvre foncé*).

La finition standard du cirage est mate (5÷20 gloss) et est réalisée avec vernis polyuréthane selon la réglementation en vigueur.

Tous les produits peuvent avoir une finition brillante brossée hi-gloss (100 gloss). **En ce cas il faudra compter un supplément de + 20%.**

ALLGEMEINE KENNEZEICHNUNG UND BEACHTUNG

➤ **STOFFE:** Es ist moeglich, dass Stoffe in verschiedenen Kategorien bei einer Partie zur anderen geringe Farbabweichungen haben koennen. Diese Unterschiede im Farbton muessen akzeptiert werden und gehen nicht zu Lasten von *i 4 Mariani S.p.A.* Sie sind daher kein Reklamationsgrund und begruenden keinen Schadensersatzanspruch. Sie koennen aber auf Wunsch ein Muster von der jeweils lagernden Stockware anfordern. Besteht ein Auftrag aus Stoffen, die verschiedenen Preiskategorien angeh hoeren, wird stets der hoehere Preis berechnet. Bei Verwendung von Kunden – oder Fremdstoffen - Kat. COM - muessen diese an *i 4 Mariani S.p.A* geliefert werden, anderenfalls erfolgt Ruecksendung. Die Voerder und Rueckseite dieser Stoffe muessen genau gekennzeichnet sein, ebenso die genaue Laenge und Breite und der genaue Rapport.

➤ **LEDER UND RINDLEDER:** Es ist moeglich, dass Leder und Rindleder in verschiedenen Kategorien bei einer Partie zur anderen geringe Farbabweichung auf weisen koennen. Diese Unterschiede im Farbton muessen, akzeptiert werden und gehen nicht zu Lasten von *i 4 Mariani S.p.A.* Sie sind daher kein Reklamationsgrund und begruenden keinen Schadensersatzanspruch. Sie koennen aber auf Wunsch ein Muster von der jeweils lagernden Stockware anfordern.

Unsere Gerberei ist beauftragt, ueberall in Europa nur die besten Haeute auszusuchen, fuer die richtige Behandlung des Leders und der Farbe mittels Chromgerbung zu sorgen, auf die Verwendung atoxischer Stoffe zu achten, und die nachfolgend angegebene Staerke der verschiedenen Leder einzuhalten. Alle Leder unserer Kollektion enthalten kein Pentachlorophenol.

RINDLEDER

CV – Cuoio Vegetale: Vegetabile gegerbtes Kalbrindleder in der Staerke 3,2÷3, 4 mm. Ausarbeiten mit Anilin.

CF – Cuoio Pieno Fiore: Kalbrindleder in der Staerke 3,0÷3, 2 mm.

CS – Cuoietto: Rindleder in der Staerke 2,4÷2,5 mm.

LEDER

PA – Pelle Atelier: Kalbsrindleder in der veraenderliche Staerke seit 1,0 zu 1,5 mm.; die verschiedene Leder-Typologien dieser Kategorie erfahren wertvolle Behandlungen auf Grund von Anilin.

PX – Pelle Extra: Kalbsrindleder in der veraenderliche Staerke seit 1,3 zu 2,0 mm.; die verschiedene Leder-Typologien dieser Kategorie erfahren wertvolle Behandlungen auf Grund von Anilin.

PF – Pelle Fiore: Kalbleder in der Staerke 1,2÷1,4 mm.

PS – Pelle Mezzo Fiore: Half Grain Leder in der Staerke 0,9÷1,1 mm.

ACHTUNG

Besondere Aufmerksamkeit muss Leder gewidmet werden, das folgenden Kategorien angehört:

CV – Cuoio Vegetale

PA – Pelle Atelier

PX – Pelle Extra

Diese Behandlungen verleihen jeder einzel Haut unbestaendige oberflaechliche Vollendungen und Farbtone oder Nuancierungen, die koennen in verschiedenen Punkten von jedem Artikel auch existieren. Fuer diesen Gruenden **koennen keine Reklamationen** ueber die Veraenderlichkeit der Flaechen und des Nuancierung akzeptiert werden.

Diese Leder sind wirklich sehr empfindlich und erfordern grosse Sorgfalt und Aufmerksamkeit weil ohne jede Schutzbehandlung der Oberflaechen sind:

- In der Fall von Flecken, man muss sofort trocken, vor dem fluessigen Produkt innerhalb eindringt, um bleibende Flecken zu lassen.
- Direkte Sonneneinstrahlung vermeiden, Ursachen Farbe zu verblassen.
- Direkte Einwirkung von Hitze zu vermeiden.

➤ **HOLZ:** Bei der Fertigung der verschiedenen Chef Modelle finden furnierte Holzplatten in der Staerke von 0,8 mm. und in der Kantenstaerke von 1÷2 mm. in verschiedenen Holzarten Verwendung:

- **Ebenholz** (*Diospyros celebica*): spezifisches Gewicht 1.100 kg/mc.

- **Eukalyptus** (*Eucalyptus rostrata*): spezifisches Gewicht 820÷850 kg/mc.

- **Lati** (*Amphimas ferrugineus o pterocarpoides*): spezifisches Gewicht 500 kg/mc.

- **Nussbaum** (*Juglans Regia*): spezifisches Gewicht 600 kg/mc (*mit Vollendung blonde gestreift Nussbaumholz*).

- **Americanische Nussbaum** (*Juglans nigra*): spezifisches Gewicht 650÷700 kg/mc.

- **Zeburanholz** (*Microberlinia brazzavillensis*): spezifisches Gewicht 500÷800 kg/mc.

- **Ebenholz Typ** (*Ayousholz - Triplochiton scleroxylon*): spezifisches Gewicht 420 kg/mc.

- **Palissander Holz Typ** (*Ayousholz - Triplochiton scleroxylon*): spezifisches Gewicht 420 kg/mc.

- **Eiche Typ** (*Ayousholz - Triplochiton scleroxylon*): spezifisches Gewicht 420 kg/mc. (*mit Vollendung natur Eiche oder dunkel Eiche*).

Standard Polierung ist undurchsichtig Typ (5÷20 gloss) und ist aus Polyurethan Beschichtungen gemaess den geltenden Vorschriften.

Alle Produkte koennen auch mit dem Polierung mit einer gebuersteten glaenzenden Oberflaechen hergestellt werden hi –gloss (100 gloss). **In diesem Fall ist der Mehrpreis gleich + 20%.**

CARACTERÍSTICAS Y ADVERTENCIAS

- **TEJIDOS:** Es posible que los tejidos de las diferentes categorías puedan presentar sutiles variaciones de tonalidad de color de una pieza a otra. Estas diferencias son tolerables y no dependen de la empresa *i 4 Mariani S.p.A.* y por tanto no se pueden pedir daños o cambios. De todas formas ustedes pueden pedir una muestra de dicho tejido. Cuando un pedido está hecho con tejidos pertenecientes a diferentes categorías, hay que aplicar el precio de la categoría más cara. Para los tejidos enviados por los clientes (cat.COM) tienen que ser enviados a portes pagados, de otro modo hay que devolverlos al remitente. Además **hay que señalar cual es el derecho y el revés de la tela así como el sentido del diseño**, para evitar errores.

- **PIEL Y CUERO:** Es posible que las diferentes tipologías de pieles y cuero puedan presentar sutiles variaciones de tonalidad de colores de una partida a otra. Estas diferencias son tolerables y no dependen de la empresa *i 4 Mariani S.p.A.* y por tanto no se pueden pedir daños o cambios. De todas formas ustedes pueden pedir una muestra de dicho cuero. Las tenerías encargadas per la empresa *i 4 Mariani S.p.A.*, seleccionan sólo y exclusivamente las mejores pieles bovinas de procedencia europea. Las mismas están sometidas a diferentes tratamientos de tanaje (al cromo para la piel y al cromo-vegetal para el cuero), y de color en todo su espesor, según las tonalidades de nuestra colección. Toda la piel y el cuero de la colección non llevan Pentaclorofenolo.

CUERO

CV – Cuoio Vegetale: Cuero plena flor curtido vegetal y con espesor 3,2÷3,4 mm. Tratamiento final a base de anilina.

CF – Cuoio Pieno Fiore: Cuero plena flor espesor 3,0÷3,2 mm.

CS – Cuoietto: Cuero espesor 2,4÷2,5 mm.

PIEL

PA – Pelle Atelier Piel bovina plena flor con espesor variable de 1,0 / 1,5 mm. Las pieles pertenecientes a esta categoría se someten a tratamientos muy especiales a base de anilina.

PX – Pelle Extra Piel bovina plena flor con espesor variable de 1,0 / 1,5 mm. Las pieles pertenecientes a esta categoría se someten a tratamientos muy especiales a base de anilina.

PF – Pelle Fiore Piel bovina plena flor espesor 1,2÷1,4 mm.

PS – Pelle Mezzo Fiore: Piel bovina media flor espesor 0,9÷1,1 mm.

ATENCIÓN

Se debe prestar especial atención a las pieles que pertenecen a las siguientes categorías:

CV – Cuoio Vegetale

PA – Pelle Atelier

PX – Pelle Extra

Estos tratamientos dan a cada piel un acabado superficial y tonalidad de color muy variables y por tanto es posible y normal que el producto final tenga diferencias de acabado y color. Dado que éstas son las características peculiares de la piel extra **no se aceptará ninguna reclamación que tenga relación con el color o con el acabado.**

El hecho de que estas pieles no incorporen ningun tratamiento de proteccion de la superficie, hace que sean realmente muy delicadas y requieran de un gran cuidado y atencion:

- En el caso de manchas de liquidos se deben secar inmediatamente antes de que el producto penetre en el interior, dejando manchas indelebles.
- Evite la luz solar directa , de lo contrario conllevará a una perdida del color.
- Evitar la exposicion directa a fuentes de calor.

- **ESENCIA DE MADERA:** Para la realización de algunos modelos de dirección se utiliza madera (hoja espesor 0,8 mm) borde en madera espesor 1÷2 mm. Las madera son las siguientes :

- **Ebano macassar** (*Diospyros celebica*): peso específico 1.100 Kg/mc.
- **Eucalipto** (*Eucaliptus rostrata*): peso específico 820÷850 kg/mc.
- **Lati** (*Amphimas ferrugineus o pterocarpoides*): peso específico 500 kg/mc.
- **Nogal** (*Juglans Regia*): peso específico 600kg/mc. (*nogal rubio rayado*).
- **Nogal americano** (*Juglans nigra*): peso específico 650÷700 kg/mc.
- **Zebrano** (*Microberlinia brazzavillensis*): peso específico 500÷800 kg/mc . Utilizado para el modelo “ARES” y “DOLMEN”
- **Efecto ebano** (*Madera de Ayous - Triplochiton scleroxylon*): peso específico 420 kg/mc . Utilizado para el modelo “AVATAR”, “DE_SYMETRIA” y “METEORA”
- **Efecto palisandro** (*Madera de Ayous - Triplochiton scleroxylon*): peso específico 420 kg/mc . Utilizado para el modelo “CROSSING”
- **Efecto roble** (*Madera de Ayous - Triplochiton scleroxylon*): peso específico 420 kg/mc . Utilizado para el modelo “BLADE” (*con acabado roble natural o roble moro*) y “PAPIER” (*con acabado roble moro*)

La pulidura estándar es de tipo opaco (5÷20 gloss) y está hecho de revestimientos de poliuretano de acuerdo con la normativa aplicable.

Todos los productos también se pueden hacer con pulidura brillante cepillada (100 gloss). **En este caso, el suplemento de la tarifa es igual a + 20%.**

FINITURE DISPONIBILI DI SERIE - STANDARD AVAILABLE FINISH

ESSENZE DI LEGNO - WOOD VENEERS



Tipo Rovere Naturale
(Verniciatura poro aperto 5 gloss)
Natural Oak Type Wood
(Open pore varnish 5 gloss)

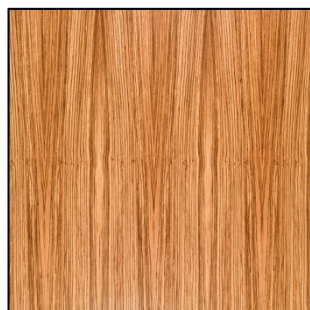

Zebrano
(Verniciatura poro pieno 20 gloss)
Zebrawood
(Closed pore varnish 20 gloss)

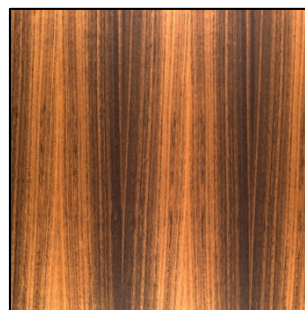

Eucalipto
(Verniciatura poro aperto 0 gloss)
Eucalyptus Wood
(Open pore varnish 0 gloss)

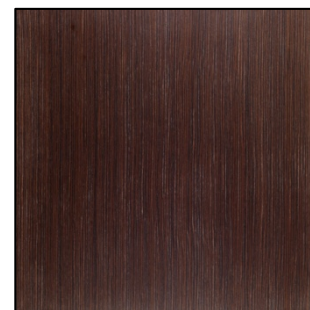

Tipo Rovere Moro
(Verniciatura poro aperto 5 gloss)
Dark Brown Oak Type Wood
(Open pore varnish 5 gloss)

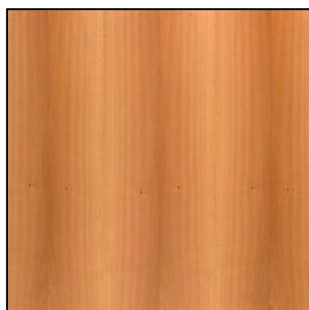

Noce Biondo Rigato
(Verniciatura poro pieno 20 gloss)
Striped Blonde Walnut Wood
(Closed pore varnish 20 gloss)

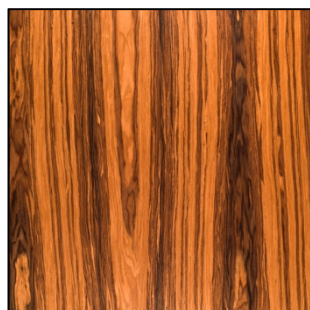

Tipo Palissandro
(Verniciatura poro pieno 20 gloss)
Rosewood Type
(Closed pore varnish 20 gloss)

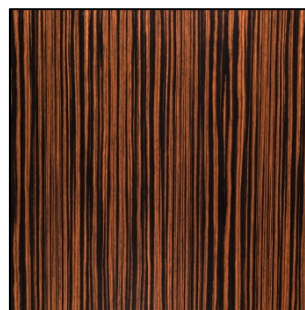

Tipo Ebano
(Verniciatura poro pieno 20 gloss)
Ebony Type Wood
(Closed pore varnish 20 gloss)

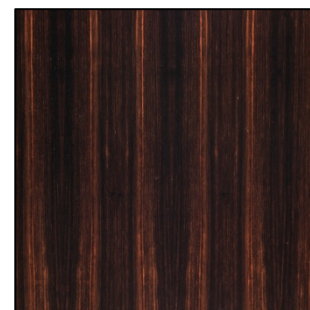

Ebano Macassar
(Verniciatura poro pieno 20 gloss)
Macassar Ebony Wood
(Closed pore varnish 20 gloss)

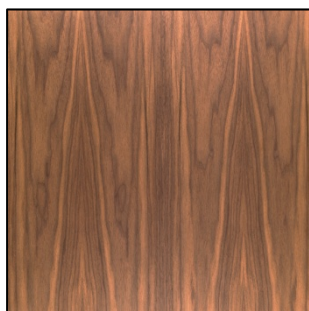

Noce Canaletto Fiammato
(Verniciatura effetto cera 0 gloss)
Veined Black Walnut Wood
(Wax effect varnish 0 gloss)

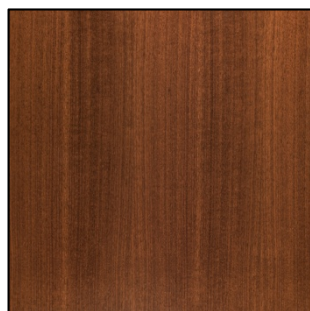

Noce Canaletto Rigato
(Verniciatura poro pieno 20 gloss)
Striped Black Walnut Wood
(Closed pore varnish 20 gloss)

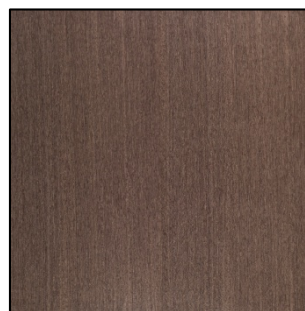

Lati
(Verniciatura poro pieno 20 gloss)
Lati Wood
(Closed pore varnish 20 gloss)

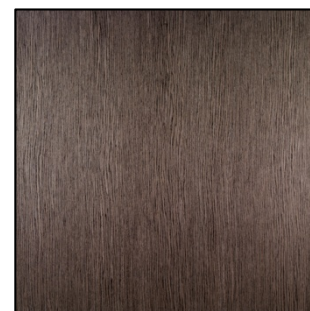

Tipo Rovere Titanio
(Verniciatura poro aperto 5 gloss)
Titanium Oak Type Wood
(Open pore varnish 5 gloss)

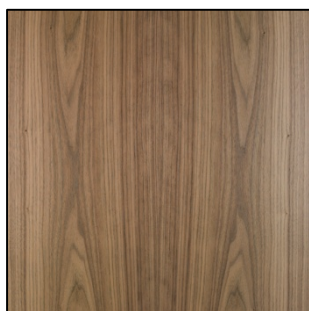

Noce Canaletto Fiammato Tinto Grigio
(Verniciatura effetto cera 0 gloss)
Grey Stained Veined Black Walnut Wood
(Wax effect varnish 0 gloss)

FINITURE DISPONIBILI DI SERIE - STANDARD AVAILABLE FINISH

MELAMINICI - MELAMINE

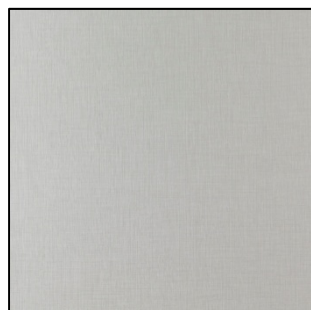

Melaminico Lino
Linen Melamine

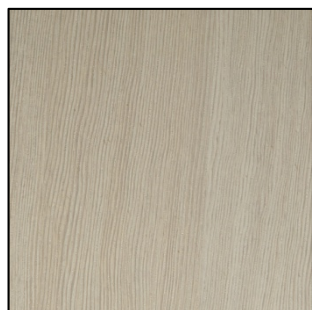

Melaminico Rovere Bianco
White Oak Melamine

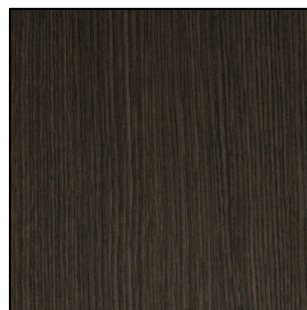

Melaminico Rovere Grigio
Grey Oak Melamine

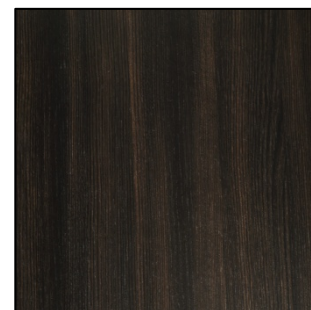

Melaminico Rovere Spessart
Spessart Oak Melamine

VERNICIATURE SPECIALI - SPECIAL PAINT FINISHING



Argento Satinato
Satin Silver

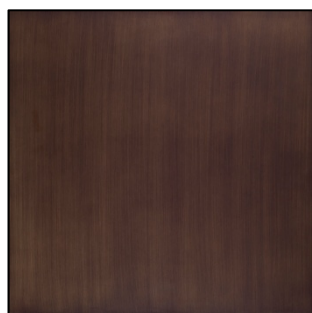

Bronzo Satinato
Satin Bronze

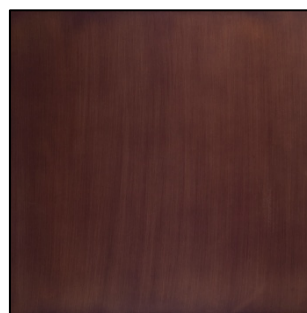

Rame Satinato
Satin Copper

FINITURE DISPONIBILI DI SERIE - STANDARD AVAILABLE FINISH

MARMI - MARBLES

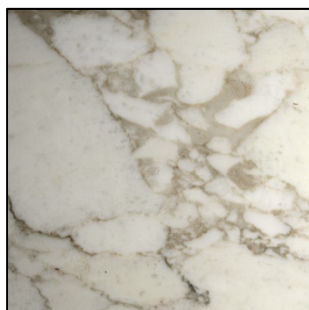

Calacatta Oro
(Italia - Italy)



Bardiglio
(Italia - Italy)

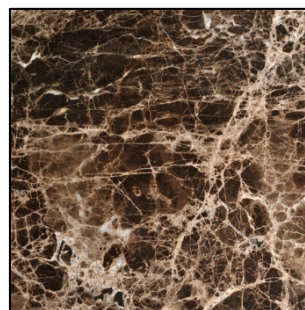

Marron Emperador
(Spagna - Spain)

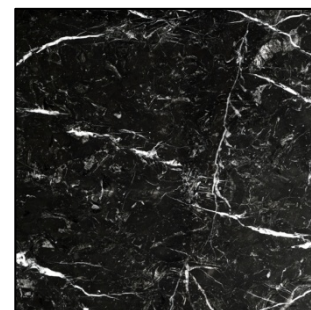

Black Marquina
(Spagna - Spain)

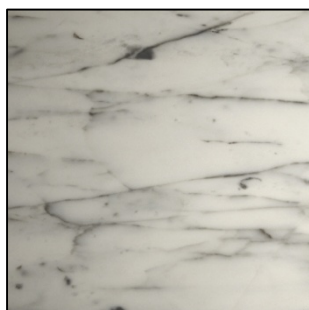

Carrara Gioia
(Italia - Italy)

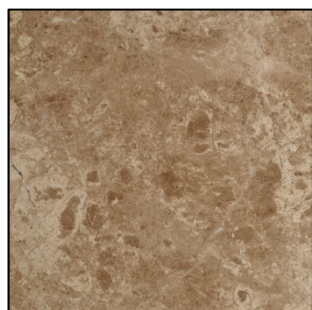

Emperador Light
(Spagna - Spain)



Forest Brown
(India - India)

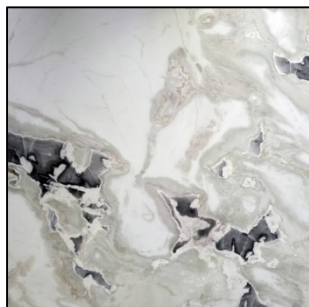

Dover White
(Italia - Italy)



Marron Damasco
(Turchia - Turkey)



Sahara Noir
(Tunisia - Tunisia)

**DIVANI POLTRONE TAVOLINI
SOFAS ARMCHAIRS LOW TABLES
CANAPES FAUTEUILS TABLES BASSES
SOFAS SESSELN TISCHEN
SOFÁS BUTACAS MESITAS**



Struttura. In legno massello di pioppo e olmo (stagionato "naturalmente" per almeno 3 anni) con elementi in multistrato di pioppo; giunzioni ad incastro con spine cilindriche. Il molleggio è garantito da cinghie elastiche in polipropilene e lattice naturale. L'imbottitura della struttura è ottenuta con lastre di poliuretano espanso indeformabile a densità differenziate (30÷35 kg/m³) esente da CFC ricoperto da ovatta poliester e vellutino accoppiato.

Cuscini. Cuscini di seduta disponibili in 3 tipologie: a) divisi in 3 camere orizzontali: le due esterne sono in piuma canalizzata mentre nella centrale c'è una lastra di poliuretano (40 kg/m³); b) completamente in poliuretano espanso a densità differenziate; c) in poliuretano espanso con parte frontale superiore del cuscino in Rollofill®. I cuscini di schienale sono completamente in piuma canalizzata. I cuscini di schienale e di seduta sono disponibili anche con bordo a palloncino.

Base. Piedini in tubolare d'acciaio. Disponibili in finitura cromata o verniciata a polveri epossidiche in colore RAL a scelta.

Rivestimento. Disponibile in tessuto e pelle; sfoderabile solo nella versione in tessuto.

Frame. In solid poplar or elm heartwood ("naturally" seasoned for at least 3 years) with connecting elements in poplar plywood; dap joints with cylindrical dowels. The webbing is secured by elastic polypropylene and natural latex belts. The framework is upholstered with contoured sheets of resilient, CFC-free polyurethane foam (with density of 30÷35 kg/m³) covered by polyester wadding and bonded plush.

Cushions. The seat cushions are available in 3 different kinds: a) subdivided in 3 horizontal units: the two outside units are feather filled while in the central one there is a sheet of polyurethane foam (40 kg/m³); b) completely in polyurethane foam with different density; c) in polyurethane foam with front and upper part in Rollofill®. The back cushions are always feather-filled. The seat and back cushions are also available with piping.

Base. Supports in tubular steel. Available chromed or epoxy powder painted in RAL colors of your choice.

Covers. Available in fabric or leather; removable covers only for fabric version.

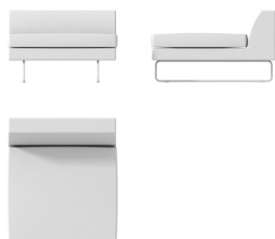

ADLOOKCENPROF

I Elemento centrale cm. 96, profondità cm. 111.
E Central unit cm. 96, depth cm. 111.
F Élément central cm. 96, profondeur cm. 111.
D Zentral Element cm. 96, Tiefe cm. 111.
S Modulo central de cm. 96, profundidad cm. 111.

cm. 96 x 111 x h 65 – hs 42 • mt. 5.40
in. 37³/₈ x 43³/₈ x h 25³/₈ – hs 16³/₈ • yd. 5.90

COM	1.693,00
L	1.799,00
T	1.926,00
S	2.032,00
Z	2.159,00
K	2.265,00
PS	2.690,00
PF	3.043,00
PX	3.888,00
PA	4.523,00

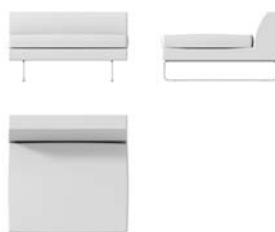

ADLOOKCE111PR

I Elemento centrale cm. 111, profondità cm. 111.
E Central unit cm. 111, depth cm. 111.
F Élément central cm. 111, profondeur cm. 111.
D Zentral Element cm. 111, Tiefe cm. 111.
S Modulo central de cm. 111, profundidad cm. 111.

cm. 111 x 111 x h 65 – hs 42 • mt. 6.60
in. 43³/₈ x 43³/₈ x h 25³/₈ – hs 16³/₈ • yd. 7.21

COM	1.782,00
L	1.916,00
T	2.076,00
S	2.209,00
Z	2.370,00
K	2.504,00
PS	2.964,00
PF	3.446,00
PX	4.216,00
PA	4.938,00









ADLOOK2POSBPR

I Divano 2 posti senza braccioli, profondità cm. 111.
E 2 seater sofa without arms, depth cm. 111.
F Canapé 2 places sans accoudoirs, profondeur cm. 111.
D Sofa 2-sitzig ohne Armlehne, Tiefe cm. 111.
S Sofá de 2 plazas sin brazos, profundidad cm. 111.

cm. 163 x 111 x h 65 – hs 42 • mt. 6.60
in. 64³/₈ x 43³/₈ x h 25³/₈ – hs 16³/₈ • yd. 7.21

COM	2.587,00
L	2.721,00
T	2.882,00
S	3.016,00
Z	3.175,00
K	3.309,00
PS	3.974,00
PF	4.464,00
PX	5.533,00
PA	6.342,00







ADD_LOOK - Design Mauro Lipparini

	<p>ADLOOK2POPRDX</p> <p>I Divano 2 posti con bracciolo destro cm. 158, profondità cm. 111. E 2 seater sofa with right arm cm. 158, depth cm. 111. F Canapé 2 places avec accoudoir droit cm. 158, profondeur cm. 111. D Sofa 2-sitzig mit rechter Armlehne cm. 158, Tiefe cm. 111. S Sofá de 2 plazas con brazo derecho cm. 158, profundidad cm. 111.</p>	<p>COM 2.348,00 L 2.482,00 T 2.643,00 S 2.777,00 Z 2.938,00 K 3.070,00 PS 3.686,00 PF 4.156,00 PX 5.183,00 PA 5.959,00</p>
	<p>ADLOOK2POPRSX</p> <p>I Divano 2 posti con bracciolo sinistro cm. 158, profondità cm. 111. E 2 seater sofa with left arm cm. 158, depth cm. 111. F Canapé 2 places avec accoudoir gauche cm. 158, profondeur, cm. 111. D Sofa 2-sitzig mit linker Armlehne cm. 158, Tiefe cm. 111. S Sofá de 2 plazas con brazo izquierdo cm. 158, profundidad cm. 111.</p>	<p>COM 2.348,00 L 2.482,00 T 2.643,00 S 2.777,00 Z 2.938,00 K 3.070,00 PS 3.686,00 PF 4.156,00 PX 5.183,00 PA 5.959,00</p>
	<p>ADLOOK2PIPROF</p> <p>I Divano 2 posti cm. 183, profondità cm. 111. E 2 seater sofa cm. 183, depth cm. 111. F Canapé 2 places cm. 183, profondeur cm. 111. D Sofa 2-sitzig cm. 183, Tiefe cm. 111. S Sofá de 2 plazas cm. 183 profundidad cm. 111.</p>	<p>COM 2.658,00 L 2.813,00 T 2.997,00 S 3.151,00 Z 3.335,00 K 3.489,00 PS 4.188,00 PF 4.728,00 PX 5.899,00 PA 6.788,00</p>
	<p>ADLOOK2GRPRDX</p> <p>I Divano 2 posti con bracciolo destro cm. 188, profondità cm. 111. E 2 seater sofa with right arm cm. 188, depth cm. 111. F Canapé 2 places avec accoudoir droit cm. 188, profondeur cm. 111. D Sofa 2-sitzig mit rechter Armlehne cm. 188, Tiefe cm. 111. S Sofá de 2 plazas con brazo derecho cm. 188, profundidad cm.111.</p>	<p>COM 2.766,00 L 2.919,00 T 3.103,00 S 3.257,00 Z 3.441,00 K 3.596,00 PS 4.328,00 PF 4.868,00 PX 6.039,00 PA 6.928,00</p>
	<p>ADLOOK2GRPRSX</p> <p>I Divano 2 posti con bracciolo sinistro cm. 188, profondità cm. 111. E 2 seater sofa with left arm cm. 188, depth cm. 111. F Canapé 2 places avec accoudoir gauche cm. 188, profondeur cm. 111 D Sofa 2-sitzig mit linker Armlehne cm. 188, Tiefe cm. 111. S Sofá de 2 plazas con brazo izquierdo cm. 188, profundidad cm.111.</p>	<p>COM 2.766,00 L 2.919,00 T 3.103,00 S 3.257,00 Z 3.441,00 K 3.596,00 PS 4.328,00 PF 4.868,00 PX 6.039,00 PA 6.928,00</p>
	<p>ADLOOK2GRPROF</p> <p>I Divano 2 posti cm. 213, profondità cm. 111. E 2 seater sofa cm. 213, depth cm. 111. F Canapé 2 places cm. 213, profondeur cm. 111. D Sofa 2-sitzig cm. 213, Tiefe cm. 111. S Sofá de 2 plazas cm. 213, profundidad cm. 111.</p>	<p>COM 3.062,00 L 3.238,00 T 3.449,00 S 3.626,00 Z 3.837,00 K 4.013,00 PS 4.817,00 PF 5.434,00 PX 6.782,00 PA 7.801,00</p>





ADD_LOOK - Design Mauro Lipparini

	<p>ADLOOK3POPRDX</p> <p>I Divano 3 posti con bracciolo destro, profondità cm. 111. E 3 seater sofa with right arm, depth cm. 111. F Canapé 3 places avec accoudoir droit, profondeur cm. 111. D Sofa 3-sitzig mit rechter Armlehne, Tiefe cm. 111. S Sofá de 3 plazas con brazo derecho, profundidad cm. 111.</p>	<p>COM 2.939,00 L 3.106,00 T 3.306,00 S 3.472,00 Z 3.672,00 K 3.839,00 PS 4.624,00 PF 5.209,00 PX 6.463,00 PA 7.458,00</p>
	<p>ADLOOK3POPRSX</p> <p>I Divano 3 posti con bracciolo sinistro, profondità cm. 111. E 3 seater sofa with left arm, depth cm. 111. F Canapé 3 places avec accoudoir gauche, profondeur cm. 111. D Sofa 3-sitzig mit linker Armlehne, Tiefe cm. 111. S Sofá de 3 plazas con brazo izquierdo, profundidad cm. 111.</p>	<p>COM 2.939,00 L 3.106,00 T 3.306,00 S 3.472,00 Z 3.672,00 K 3.839,00 PS 4.624,00 PF 5.209,00 PX 6.463,00 PA 7.459,00</p>
	<p>ADLOOK3POPROF</p> <p>I Divano 3 posti cm. 243, profondità cm. 111. E 3 seater sofa cm. 243, depth cm. 111. F Canapé 3 places cm. 243, profondeur cm. 111. D Sofa 3-sitzig cm. 243, Tiefe cm. 111. S Sofá de 3 plazas 243 cm. profundidad cm. 111.</p>	<p>COM 3.255,00 L 3.445,00 T 3.674,00 S 3.864,00 Z 4.092,00 K 4.283,00 PS 5.145,00 PF 5.765,00 PX 7.267,00 PA 8.404,00</p>
	<p>ADLOOKEL135PR</p> <p>I Elemento angolare a 135°, profondità cm. 111. E 135° corner element, depth cm. 111. F Élément de coin 135°, profondeur cm. 111. D 135° Eckelement, Tiefe cm. 111. S Elemento de esquina de 135° profundidad cm. 111.</p>	<p>COM 3.911,00 L 4.223,00 T 4.597,00 S 4.909,00 Z 5.283,00 K 5.595,00 PS 6.722,00 PF 7.858,00 PX 9.676,00 PA 11.380,00</p>
	<p>ADLOOKCENNORM</p> <p>I Elemento centrale cm. 96, profondità cm. 96. E Central unit cm. 96, depth cm. 96. F Élément central cm. 96, profondeur cm. 96. D Zentral Element cm. 96, Tiefe cm. 96. S Módulo central de cm. 96, profundidad cm. 96.</p>	<p>COM 1.523,00 L 1.612,00 T 1.719,00 S 1.808,00 Z 1.915,00 K 2.004,00 PS 2.378,00 PF 2.691,00 PX 3.366,00 PA 3.881,00</p>
	<p>ADLOOKCE111NO</p> <p>I Elemento centrale cm. 111, profondità cm. 96. E Central unit cm. 111, depth cm. 96. F Élément central cm. 111, profondeur cm. 96. D Zentral Element cm. 111, Tiefe cm. 96. S Módulo central de cm. 111, profundidad cm. 96.</p>	<p>COM 1.564,00 L 1.675,00 T 1.809,00 S 1.920,00 Z 2.054,00 K 2.165,00 PS 2.547,00 PF 2.949,00 PX 3.591,00 PA 4.192,00</p>

ADD_LOOK - Design Mauro Lipparini

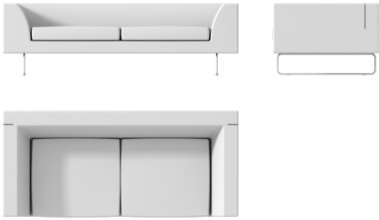
	<p>ADLOOK2POSBNO</p> <p>I Divano 2 posti senza braccioli, profondità cm. 96. E 2 seater sofa without arms, depth cm. 96. F Canapé 2 places sans accoudoirs, profondeur cm. 96. D Sofa 2-sitzig ohne Armlehnen, Tiefe cm. 96. S Sofá de 2 plazas sin brazos, profundidad cm. 96.</p>	<p>COM 2.289,00 L 2.408,00 T 2.553,00 S 2.673,00 Z 2.817,00 K 2.938,00 PS 3.534,00 PF 3.976,00 PX 4.940,00 PA 5.668,00</p>
	<p>ADLOOK2PINODX</p> <p>I Divano 2 posti con bracciolo destro cm. 158. E 2 seater sofa with right arm cm. 158. F Canapé 2 places avec accoudoir droit cm. 158. D Sofa 2-sitzig mit rechter Armlehne cm. 158. S Sofá de 2 plazas con brazo derecho cm. 158.</p>	<p>COM 2.270,00 L 2.395,00 T 2.544,00 S 2.670,00 Z 2.819,00 K 2.944,00 PS 3.518,00 PF 3.956,00 PX 4.908,00 PA 5.630,00</p>
	<p>ADLOOK2PINOSX</p> <p>I Divano 2 posti con bracciolo sinistro cm. 158. E 2 seater sofa with left arm cm. 158. F Canapé 2 places avec accoudoir gauche cm. 158. D Sofa 2-sitzig mit linker Armlehne cm. 158. S Sofá de 2 plazas con brazo izquierdo cm. 158.</p>	<p>COM 2.270,00 L 2.395,00 T 2.544,00 S 2.670,00 Z 2.819,00 K 2.944,00 PS 3.518,00 PF 3.956,00 PX 4.908,00 PA 5.630,00</p>
	<p>ADLOOK2PINORM</p> <p>I Divano 2 posti cm. 183. E 2 seater sofa cm. 183. F Canapé 2 places cm. 183. D Sofa 2-sitzig cm. 183. S Sofá de 2 plazas cm. 183.</p>	<p>COM 2.584,00 L 2.734,00 T 2.913,00 S 3.062,00 Z 3.241,00 K 3.390,00 PS 4.063,00 PF 4.588,00 PX 5.734,00 PA 6.599,00</p>
	<p>ADLOOK2GRNODX</p> <p>I Divano 2 posti con bracciolo destro cm. 188. E 2 seater sofa with right arm cm. 188. F Canapé 2 places avec accoudoir droit cm. 188. D Sofa 2-sitzig mit rechter Armlehne cm. 188. S Sofá de 2 plazas con brazo derecho cm. 188.</p>	<p>COM 2.504,00 L 2.647,00 T 2.818,00 S 2.960,00 Z 3.131,00 K 3.274,00 PS 3.937,00 PF 4.437,00 PX 5.540,00 PA 6.368,00</p>
	<p>ADLOOK2GRNOSX</p> <p>I Divano 2 posti con bracciolo sinistro cm. 188. E 2 seater sofa with left arm cm. 188. F Canapé 2 places avec accoudoir gauche cm. 188. D Sofa 2-sitzig mit linker Armlehne cm. 188. S Sofá de 2 plazas con brazo izquierdo cm. 188.</p>	<p>COM 2.504,00 L 2.647,00 T 2.818,00 S 2.960,00 Z 3.131,00 K 3.274,00 PS 3.937,00 PF 4.437,00 PX 5.540,00 PA 6.368,00</p>

ADD_LOOK - Design Mauro Lipparini

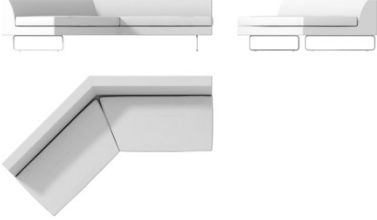
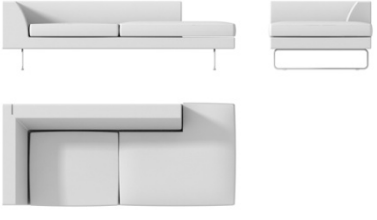
	<p>ADLOOK2GRNORM</p> <p>I Divano 2 posti cm. 213. E 2 seater sofa cm. 213. F Canapé 2 places cm. 213. D Sofa 2-sitzig cm. 213. S Sofá de 2 plazas cm. 213.</p>	<p>COM 2.825,00 L 2.994,00 T 3.197,00 S 3.367,00 Z 3.570,00 K 3.739,00 PS 4.508,00 PF 5.103,00 PX 6.457,00 PA 7.453,00</p>
	<p>ADLOOK3PONODX</p> <p>I Divano 3 posti con bracciolo destro. E 3 seater sofa with right arm. F Canapé 3 places avec accoudoir droit. D Sofa 3-sitzig mit rechter Armlehne. S Sofá de 3 plazas con brazo derecho.</p>	<p>COM 2.792,00 L 2.957,00 T 3.155,00 S 3.320,00 Z 3.517,00 K 3.682,00 PS 4.700,00 PF 5.367,00 PX 6.438,00 PA 7.440,00</p>
	<p>ADLOOK3PONOSX</p> <p>I Divano 3 posti con bracciolo sinistro. E 3 seater sofa with left arm. F Canapé 3 places avec accoudoir gauche. D Sofa 3-sitzig mit linker Armlehne. S Sofá de 3 plazas con brazo izquierdo.</p>	<p>COM 2.792,00 L 2.957,00 T 3.155,00 S 3.320,00 Z 3.517,00 K 3.682,00 PS 4.700,00 PF 5.367,00 PX 6.438,00 PA 7.440,00</p>
	<p>ADLOOK3PONORM</p> <p>I Divano 3 posti. E 3 seater sofa. F Canapé 3 places. D Sofa 3-sitzig. S Sofá de 3 plazas.</p>	<p>COM 3.054,00 L 3.242,00 T 3.470,00 S 3.660,00 Z 3.886,00 K 4.076,00 PS 4.942,00 PF 5.607,00 PX 7.053,00 PA 8.149,00</p>
	<p>ADLOOKEL135NO</p> <p>I Elemento angolare a 135°, profondità cm. 96. E 135° corner element, depth cm. 96. F Élément de coin 135°, profondeur cm. 96. D 135° Eckelement, Tiefe cm. 96. S Elemento de esquina de 135° profundidad cm 96.</p>	<p>COM 3.820,00 L 4.110,00 T 4.458,00 S 4.747,00 Z 5.094,00 K 5.385,00 PS 6.476,00 PF 7.545,00 PX 9.256,00 PA 10.860,00</p>
	<p>ADLOOKCHAISDX</p> <p>I Chaiselongue destra. E Right chaiselongue. F Dormeuse droite. D Rechte Dormeuse. S Chaise longue derecha.</p>	<p>COM 2.638,00 L 2.793,00 T 2.981,00 S 3.136,00 Z 3.324,00 K 3.479,00 PS 4.019,00 PF 4.580,00 PX 5.479,00 PA 6.321,00</p>

ADD_LOOK - Design Mauro Lipparini

	<p>ADLOOKCHAISX</p> <p>I Chaiselongue destra. E Right chaiselongue. F Dormeuse droite. D Rechte Dormeuse. S Chaise longue derecha.</p>	<p>COM 2.638,00 L 2.793,00 T 2.981,00 S 3.136,00 Z 3.324,00 K 3.479,00 PS 4.019,00 PF 4.580,00 PX 5.479,00 PA 6.321,00</p>
	<p>ADLOOKDORMEDX</p> <p>I Chaiselongue destra. E Right chaiselongue. F Dormeuse droite. D Rechte Dormeuse. S Chaise longue derecha.</p>	<p>COM 2.422,00 L 2.562,00 T 2.730,00 S 2.871,00 Z 3.039,00 K 3.180,00 PS 3.703,00 PF 4.180,00 PX 5.225,00 PA 6.014,00</p>
	<p>ADLOOKDORMESX</p> <p>I Chaiselongue sinistra. E Left chaiselongue. F Dormeuse gauche. D Linke Dormeuse. S Chaise longue izquierda.</p>	<p>COM 2.422,00 L 2.562,00 T 2.730,00 S 2.871,00 Z 3.039,00 K 3.180,00 PS 3.703,00 PF 4.180,00 PX 5.225,00 PA 6.014,00</p>
	<p>ADLOOKPENISDX</p> <p>I Penisola lineare destra. E Right linear chaiselongue. F Dormeuse linéaire droite. D Rechte lineare Dormeuse. S Chaise longue lineal derecha.</p>	<p>COM 2.118,00 L 2.254,00 T 2.416,00 S 2.552,00 Z 2.716,00 K 2.852,00 PS 3.307,00 PF 3.755,00 PX 4.742,00 PA 5.484,00</p>
	<p>ADLOOKPENISSX</p> <p>I Penisola lineare sinistra. E Left linear chaiselongue. F Dormeuse linéaire gauche. D Linke lineare Dormeuse. S Chaise longue lineal izquierda.</p>	<p>COM 2.118,00 L 2.254,00 T 2.416,00 S 2.552,00 Z 2.716,00 K 2.852,00 PS 3.307,00 PF 3.755,00 PX 4.742,00 PA 5.484,00</p>
	<p>ADLOOKPEDX/TA</p> <p>I Penisola lineare destra con tavolino fisso in cuoio. E Right linear chaiselongue with fixed saddle leather small table. F Dormeuse linéaire droite avec petit table en cuir épais. D Rechte lineare Dormeuse mit festem Rindleder Kaffee-tish. S Chaise longue lineal derecha con mesita auxiliar en cuero.</p>	<p>COM 3.031,00 L 3.147,00 T 3.286,00 S 3.402,00 Z 3.541,00 K 3.657,00 PS 4.193,00 PF 4.616,00 PX 5.539,00 PA 6.238,00</p>

ADD_LOOK - Design Mauro Lipparini

	<p>ADLOOKPESX/TA</p> <p>I Penisola lineare sinistra con tavolino fisso in cuoio. E Left linear chaiselongue with fixed saddle leather small table. F Dormeuse linéaire gauche avec petit table en cuir épais. D Linke lineare Dormeuse mit festem Rindleder Kaffee-tish. S Chaise longue lineal izquierda con mesita auxiliar en cuero.</p>	<p>COM 3.031,00 L 3.147,00 T 3.286,00 S 3.402,00 Z 3.541,00 K 3.657,00 PS 4.193,00 PF 4.616,00 PX 5.539,00 PA 6.238,00</p>	
<p>cm. 96 x 188 x h 65 – hs 42 • mt. 6.70 in. 37”$\frac{3}{4}$ x 74” x h 25”$\frac{3}{4}$ – hs 16”$\frac{1}{2}$ • yd. 7.32</p>		<p>ADLOOKPENDX30</p> <p>I Penisola angolare destra (angolo 30 gradi). E Right angular chaiselongue (30 degrees angle). F Dormeuse angulaire droite (angle de 30 degré). D Winklge rechte Dormeuse (Winkel 30 Grad). S Chaise longue lineal derecha (rincón de 30 grados).</p>	<p>COM 2.709,00 L 2.874,00 T 3.071,00 S 3.236,00 Z 3.434,00 K 3.599,00 PS 4.357,00 PF 4.958,00 PX 6.270,00 PA 7.263,00</p>
<p>cm. 224 x 140 x h 65 – hs 42 • mt. 8.20 in. 88”$\frac{1}{4}$ x 55”$\frac{1}{4}$ x h 25”$\frac{3}{4}$ – hs 16”$\frac{1}{2}$ • yd. 8.96</p>		<p>ADLOOKPENSX30</p> <p>I Penisola angolare sinistra (angolo di 30 gradi). E Left angular chaiselongue (30 degrees angle). F Dormeuse angulaire gauche (angle de 30 degré). D Winklge linke Dormeuse (Winkel 30 Grad). S Chaise longue lineal izquierda (rincón de 30 grados).</p>	<p>COM 2.709,00 L 2.874,00 T 3.071,00 S 3.236,00 Z 3.434,00 K 3.599,00 PS 4.357,00 PF 4.958,00 PX 6.270,00 PA 7.263,00</p>
<p>cm. 224 x 140 x h 65 – hs 42 • mt. 8.20 in. 88”$\frac{1}{4}$ x 55”$\frac{1}{4}$ x h 25”$\frac{3}{4}$ – hs 16”$\frac{1}{2}$ • yd. 8.96</p>		<p>ADLOOKXLANGOL</p> <p>I Angolo cm. 140x140. E Corner unit cm. 140x140. F Angle cm. 140x140. D Eckteil cm. 140x140. S Rincón cm. 140x140.</p>	<p>COM 2.938,00 L 3.094,00 T 3.283,00 S 3.439,00 Z 3.628,00 K 3.785,00 PS 4.579,00 PF 5.130,00 PX 6.345,00 PA 7.259,00</p>
<p>cm. 140 x 140 x h 65 – hs 42 • mt. 7.25 in. 55”$\frac{1}{2}$ x 55”$\frac{1}{2}$ x h 25”$\frac{3}{4}$ – hs 16”$\frac{1}{2}$ • yd. 7.92</p>		<p>ADLOOKXLCHADX</p> <p>I Chaiselongue destra, profondità cm. 140 E Right chaiselongue, depth cm. 140 F Dormeuse droite, profondeur cm. 140 D Rechte Dormeuse, Tiefe cm. 140 S Chaise longue derecha, profundidad cm. 140.</p>	<p>COM 2.999,00 L 3.155,00 T 3.342,00 S 3.498,00 Z 3.685,00 K 3.841,00 PS 4.609,00 PF 5.180,00 PX 6.428,00 PA 7.371,00</p>
<p>cm. 140 x 140 x h 65 – hs 42 • mt. 7.70 in. 55”$\frac{1}{2}$ x 55”$\frac{1}{2}$ x h 25”$\frac{3}{4}$ – hs 16”$\frac{1}{2}$ • yd. 8.42</p>		<p>ADLOOKXLCHASX</p> <p>I Chaiselongue sinistra, profondità cm. 140 E Left chaiselongue, depth cm. 140 F Dormeuse gauche, profondeur cm. 140 D Linke Dormeuse, Tiefe cm. 140 S Chaise longue izquierda, profundidad cm. 140.</p>	<p>COM 2.999,00 L 3.155,00 T 3.342,00 S 3.498,00 Z 3.685,00 K 3.841,00 PS 4.609,00 PF 5.180,00 PX 6.428,00 PA 7.371,00</p>
<p>cm. 140 x 140 x h 65 – hs 42 • mt. 7.70 in. 55”$\frac{1}{2}$ x 55”$\frac{1}{2}$ x h 25”$\frac{3}{4}$ – hs 16”$\frac{1}{2}$ • yd. 8.42</p>			

ADD_LOOK - Design Mauro Lipparini

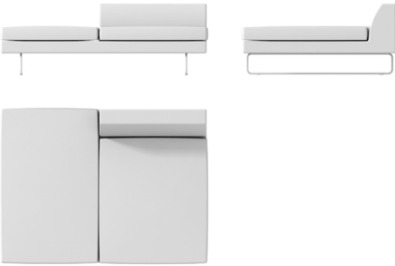
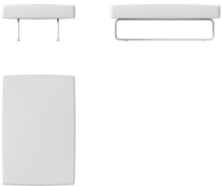
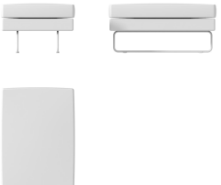
	<p>ADLOOKXLPENDX</p> <p>I Penisola destra, profondità cm. 140 E Right linear chaiselongue, depth cm. 140 F Dormeuse linéaire droite, profondeur cm. 140 D Rechte lineare Dormeuse, Tiefe cm. 140 S Chaise longue derecha, profundidad cm. 140.</p>	<p>COM 3.025,00 L 3.223,00 T 3.460,00 S 3.658,00 Z 3.894,00 K 4.092,00 PS 4.908,00 PF 5.603,00 PX 7.129,00 PA 8.278,00</p>
	<p>ADLOOKXLPENSX</p> <p>I Penisola sinistra, profondità cm. 140 E Left linear chaiselongue, depth cm. 140 F Dormeuse linéaire gauche, profondeur cm. 140 D Linke lineare Dormeuse, Tiefe cm. 140 S Chaise longue izquierda, profundidad cm. 140.</p>	<p>COM 3.025,00 L 3.223,00 T 3.460,00 S 3.658,00 Z 3.894,00 K 4.092,00 PS 4.908,00 PF 5.603,00 PX 7.129,00 PA 8.278,00</p>
	<p>ADLOOKPU9565S</p> <p>I Pouf senza cuscino cm. 96x65. E Ottoman without cushion cm. 96x65. F Pouf sans coussin cm. 96x65. D Hocker ohne Kissen cm. 96x65. S Pouf sin cojín cm. 96x65.</p>	<p>COM 839,00 L 860,00 T 886,00 S 908,00 Z 926,00 K 949,00 PS 1.070,00 PF 1.151,00 PX 1.325,00 PA 1.457,00</p>
	<p>ADLOOKPU9595S</p> <p>I Pouf senza cuscino cm. 96x96. E Ottoman without cushion cm. 96x96. F Pouf sans coussin cm. 96x96. D Hocker ohne Kissen cm. 96x96. S Pouf sin cojín cm. 96x96.</p>	<p>COM 882,00 L 901,00 T 936,00 S 965,00 Z 1.000,00 K 1.029,00 PS 1.163,00 PF 1.262,00 PX 1.475,00 PA 1.637,00</p>
	<p>ADLOOKPOU9565</p> <p>I Pouf cm. 96x65. E Ottoman cm. 96x65. F Pouf cm. 96x65. D Hocker cm. 96x65. S Pouf cm. 96x65.</p>	<p>COM 1.220,00 L 1.275,00 T 1.342,00 S 1.398,00 Z 1.465,00 K 1.520,00 PS 1.728,00 PF 1.924,00 PX 2.356,00 PA 2.680,00</p>
	<p>ADLOOKPOU9595</p> <p>I Pouf cm. 96x96. E Ottoman cm. 96x96. F Pouf cm. 96x96. D Hocker cm. 96x96. S Pouf cm. 96x96.</p>	<p>COM 1.456,00 L 1.541,00 T 1.643,00 S 1.727,00 Z 1.829,00 K 1.914,00 PS 2.216,00 PF 2.513,00 PX 3.164,00 PA 3.655,00</p>

ADD_LOOK - Design Mauro Lipparini

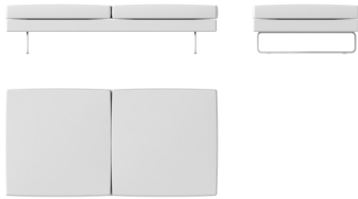

ADLOOKPU19095

I Pouf cm. 190x96.
E Ottoman cm. 190x96.
F Pouf cm. 190x96.
D Hocker cm. 190x96.
S Pouf cm. 190x96.

cm. 190 x 96 x h 42 – hs 42 • mt. 6.95
in. 74” $\frac{3}{4}$ x 37” $\frac{3}{4}$ x h 16” $\frac{1}{2}$ – hs 16” $\frac{1}{2}$ • yd. 7.60

COM	2.349,00
L	2.491,00
T	2.658,00
S	2.799,00
Z	2.967,00
K	3.108,00
PS	3.696,00
PF	4.209,00
PX	5.325,00
PA	6.171,00



ADLOOKSCHANGO

I Cuscino cm. 50x47.
E Pillow cm. 50x47.
F Coussin cm. 50x47.
D Kissen cm. 50x47.
S Cojín cm. 50x47.

cm. 50 x 47 x h 20 • mt. 0.70
in. 19” $\frac{3}{8}$ x 18” $\frac{1}{2}$ x h 7” $\frac{7}{8}$ • yd. 0.76

COM	171,00
L	182,00
T	195,00
S	205,00
Z	218,00
K	229,00
PS	281,00
PF	319,00
PX	406,00
PA	469,00



ADLOOKSCHP050

I Cuscino con piping cm. 50x47.
E Pillow with piping cm. 50x47.
F Coussin avec passepoil cm. 50x47.
D Kissen mit Keder cm. 50x47.
S Cojín con perfil cm. 50x47.

cm. 50 x 47 x h 20 • mt. 0.70
in. 19” $\frac{3}{8}$ x 18” $\frac{1}{2}$ x h 7” $\frac{7}{8}$ • yd. 0.76

COM	215,00
L	229,00
T	245,00
S	259,00
Z	275,00
K	288,00
PS	351,00
PF	397,00
PX	469,00
PA	538,00



ADLOOKSCHD2PO

I Cuscino cm. 67x47.
E Pillow cm. 67x47.
F Coussin cm. 67x47.
D Kissen cm. 67x47.
S Cojín cm. 67x47.

cm. 67 x 47 x h 20 • mt. 0.85
in. 26” $\frac{3}{8}$ x 18” $\frac{1}{2}$ x h 7” $\frac{7}{8}$ • yd. 0.93

COM	203,00
L	219,00
T	239,00
S	255,00
Z	276,00
K	293,00
PS	355,00
PF	411,00
PX	533,00
PA	624,00



ADLOOKSCHP067

I Cuscino con piping cm. 67x47.
E Pillow with piping cm. 67x47.
F Coussin avec passepoil cm. 67x47.
D Kissen mit Keder cm. 67x47.
S Cojín con perfil cm. 67x47.

cm. 67 x 47 x h 20 • mt. 0.85
in. 26” $\frac{3}{8}$ x 18” $\frac{1}{2}$ x h 7” $\frac{7}{8}$ • yd. 0.93

COM	269,00
L	289,00
T	314,00
S	335,00
Z	358,00
K	379,00
PS	440,00
PF	499,00
PX	571,00
PA	659,00











ADLOOKSCH2PGR

I Cuscino cm. 81x47.
E Pillow cm. 81x47.
F Coussin cm. 81x47.
D Kissen cm. 81x47.
S Cojín cm. 81x47.

cm. 81 x 47 x h 20 • mt. 1.00
in. 31” $\frac{7}{8}$ x 18” $\frac{1}{2}$ x h 7” $\frac{7}{8}$ • yd. 1.09

COM	224,00
L	244,00
T	268,00
S	287,00
Z	312,00
K	332,00
PS	387,00
PF	450,00
PX	588,00
PA	692,00

ADD_LOOK - Design Mauro Lipparini

 	ADLOOKSCHP081 I Cuscino con piping cm. 81x47. E Pillow with piping cm. 81x47. F Coussin avec passepoil cm. 81x47. D Kissen mit Keder cm. 81x47. S Cojín con perfil cm. 81x47.	COM	301,00
		L	325,00
		T	355,00
		S	380,00
		Z	410,00
		K	435,00
		PS	497,00
		PF	565,00
		PX	675,00
		PA	777,00
cm. 81 x 47 x h 20 • mt. 1.00 in. 31"½ x 18"½ x h 7"¾ • yd. 1.09			
 	ADLOOKSCHD3PO I Cuscino cm. 97x47. E Pillow cm. 97x47. F Coussin cm. 97x47. D Kissen cm. 97x47. S Cojín cm. 97x47.	COM	250,00
		L	274,00
		T	302,00
		S	325,00
		Z	353,00
		K	377,00
		PS	476,00
		PF	559,00
		PX	694,00
		PA	821,00
cm. 97 x 47 x h 20 • mt. 1.20 in. 38"¼ x 18"½ x h 7"¾ • yd. 1.31			
 	ADLOOKSCHP097 I Cuscino con piping cm. 97x47. E Pillow with piping cm. 97x47. F Coussin avec passepoil cm. 97x47. D Kissen mit Keder cm. 97x47. S Cojín con perfil cm. 97x47.	COM	320,00
		L	347,00
		T	380,00
		S	407,00
		Z	440,00
		K	468,00
		PS	541,00
		PF	618,00
		PX	742,00
		PA	857,00
cm. 97 x 47 x h 20 • mt. 1.20 in. 38"¼ x 18"½ x h 7"¾ • yd. 1.31			
 	ADLOOKCUSCINE I Cuscino cm. 50x40. E Pillow cm. 50x40. F Coussin cm. 50x40. D Kissen cm. 50x40. S Cojín cm. 50x40.	COM	123,00
		L	136,00
		T	152,00
		S	166,00
		Z	181,00
		K	195,00
		PS	209,00
		PF	247,00
		PX	334,00
		PA	397,00
cm. 50 x 40 x h 10 • mt. 0.70 in. 19"¾ x 15"¾ x h 7"¾ • yd. 0.76			
	ADLOOKPIPING1 I Supplemento per realizzazione di piping su 1 cuscino di seduta. E Extra charge for piping processing on 1 seating cushion. F Supplément pour la réalisation du passepoil sur 1 coussin d'assise. D Mehrpreis fuer Realisierung der Keder auf 1 Sitzkisse. S Suplemento para la realización de perfil en 1 cojín del asiento.		166,00
	ADLOOKPIPING2 I Supplemento per realizzazione di piping su 2 cuscini di seduta. E Extra charge for piping processing on 2 seating cushions. F Supplément pour la réalisation du passepoil sur 2 coussins d'assise. D Mehrpreis fuer Realisierung der Keder auf 2 Sitzkissen. S Suplemento para la realización de perfil en 2 cojines del asiento.		331,00

ADD_LOOK - Design Mauro Lipparini



Piani. I piani di tavolini e consolle sono in lamiera d'acciaio curvata; sono disponibili esclusivamente in cuoio.

Base. Piedini in tubolare d'acciaio. Disponibili in finitura cromata o verniciata a polveri epossidiche in colore RAL a scelta.

Top. Top of low tables and consoles are in curved steel sheet available only covered in saddle leather.

Base. Supports in tubular steel. Available chromed or epoxy powder painted in RAL colors of your choice.



ADLOOKCONS096

- I Console in cuoio cm. 96.
- E Console in saddle leather cm. 96.
- F Console en cuir cm. 96.
- D Konsole in Rindleder cm. 96.
- S Consola en cuero cm. 96.

CV	1.450,00
CF	1.299,00
CS	1.109,00

cm. 96 x 36 x h 64
in. 37³/₄ x 14¹/₄ x h 25³/₄



ADLOOKCONS110

- I Console in cuoio cm. 111.
- E Console in saddle leather cm. 111.
- F Console en cuir cm. 111.
- D Konsole in Rindleder cm. 111.
- S Consola en cuero cm. 111.

CV	1.543,00
CF	1.374,00
CS	1.163,00

cm. 111 x 36 x h 64
in. 43³/₄ x 14¹/₄ x h 25³/₄



ADLOOKCONS158

- I Console in cuoio cm. 158.
- E Console in saddle leather cm. 158.
- F Console en cuir cm. 158.
- D Konsole in Rindleder cm. 158.
- S Consola en cuero cm. 158.

CV	1.919,00
CF	1.687,00
CS	1.398,00

cm. 158 x 36 x h 64
in. 62³/₄ x 14¹/₄ x h 25³/₄



ADLOOKCONS183

- I Console in cuoio cm. 183.
- E Console in saddle leather cm. 183.
- F Console en cuir cm. 183.
- D Konsole in Rindleder cm. 183.
- S Consola en cuero cm. 183.

CV	2.141,00
CF	1.865,00
CS	1.520,00

cm. 183 x 36 x h 64
in. 72³/₄ x 14¹/₄ x h 25³/₄

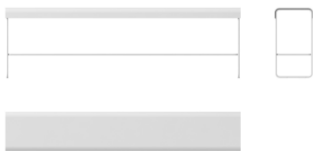

ADLOOKCONS213

- I Console in cuoio cm. 213.
- E Console in saddle leather cm. 213.
- F Console en cuir cm. 213.
- D Konsole in Rindleder cm. 213.
- S Consola en cuero cm. 213.

CV	2.362,00
CF	2.059,00
CS	1.680,00

cm. 213 x 36 x h 64
in. 83³/₄ x 14¹/₄ x h 25³/₄

ADD_LOOK - Design Mauro Lipparini



ADLOOKCONS243

- I Console in cuoio cm. 243.
- E Console in saddle leather cm. 243.
- F Console en cuir cm. 243.
- D Konsole in Rindleder cm. 243.
- S Consola en cuero cm. 243.

CV 2.586,00
CF 2.239,00
CS 1.805,00

cm. 243 x 36 x h 64
in. 95³/₈ x 14¹/₂ x h 25¹/₄



ADLOOKTAVO095

- I Tavolino in cuoio cm. 95x95.
- E Coffee table in saddle leather cm. 95x95.
- F Table basse en cuir cm. 95x95.
- D Tisch in Rindleder cm. 95x95.
- S Mesa centro en cuero cm. 95x95.

CV 1.200,00
CF 1.055,00
CS 873,00

cm. 95 x 95 x h 21
in. 37³/₈ x 37³/₈ x h 8¹/₄



ADLOOKTAVO110

- I Tavolino in cuoio cm. 110x110.
- E Coffee table in saddle leather cm. 110x110.
- F Table basse en cuir cm. 110x110.
- D Tisch in Rindleder cm. 110x110.
- S Mesa centro en cuero cm. 110x110.

CV 1.413,00
CF 1.227,00
CS 994,00

cm. 110 x 110 x h 21
in. 43³/₈ x 43³/₈ x h 8¹/₄



ADLOOKTAVO140

- I Tavolino in cuoio cm. 140x70.
- E Coffee table in saddle leather cm. 140x70.
- F Table basse en cuir cm. 140x70.
- D Tisch in Rindleder cm. 140x70.
- S Mesa centro en cuero cm. 140x70.

CV 1.276,00
CF 1.125,00
CS 935,00

cm. 140 x 70 x h 21
in. 55³/₈ x 27³/₈ x h 8¹/₄



ADLOOKTAVO050

- I Tavolino in cuoio cm. 50x50.
- E Coffee table in saddle leather cm. 50x50.
- F Table basse en cuir cm. 50x50.
- D Tisch in Rindleder cm. 50x50.
- S Mesa centro en cuero cm. 50x50.

CV 784,00
CF 729,00
CS 661,00

cm. 50 x 50 x h 50
in. 19³/₈ x 19³/₈ x h 19³/₈



ADLOOKTRIALTO

- I Tavolino impilabile in cuoio altezza cm. 58.
- E Stackable small table in saddle leather high cm. 58.
- F Table gigogne en cuir hauteur cm. 58.
- D Stapelbarer Abstelltisch in Rindleder höhe cm. 58.
- S Mesita auxiliar apilable en cuero, altura cm. 58.

CV 533,00
CF 501,00
CS 461,00

cm. 36 x 42 x h 58
in. 14¹/₂ x 16¹/₂ x h 22³/₈

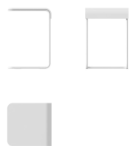

ADLOOKTRIMEDI

- I Tavolino impilabile in cuoio altezza cm. 55.
- E Stackable small table in saddle leather high cm. 55.
- F Table gigogne en cuir hauteur cm. 55.
- D Stapelbarer Abstelltisch in Rindleder höhe cm. 55.
- S Mesita auxiliar apilable en cuero, altura cm. 55.

CV 534,00
CF 502,00
CS 461,00

cm. 39 x 40 x h 55
in. 15³/₈ x 15³/₈ x h 21³/₈

ADD_LOOK - Design Mauro Lipparini

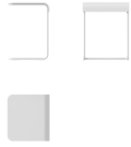

ADLOOKTRIBASS

I Tavolino impilabile in cuoio altezza cm. 52.

E Stackable small table in saddle leather high cm. 52.

F Table gigogne en cuir hauteur cm. 52.

D Stapelbarer Abstelltisch in Rindleder höhe cm. 52.

S Mesita auxiliar apilable en cuero, altura cm. 52.

CV 538,00

CF 505,00

CS 464,00

cm. 42 x 38 x h 52

in. 16¹/₂ x 15" x h 22¹/₈

ADLOOKPIEDJHO

I Supplemento per piedini cromati neri come modello "Joshua" per ogni elemento di seduta.

E Extra charge for black chromed feet as "Joshua" model for each seat element.

F Supplément pour pieds chromés noirs comme modèle "Joshua" pour chaque élément d'assise.

D Mehrpreis für schwarze Chromfüße wie "Joshua" Modell für jedes Sitzelement.

S Suplemento para pies de cromo negro como modelo "Joshua" para cada elemento del asiento.

216,00

ADD_LOOK ROUND - Design Mauro Lipparini



Struttura. In legno massello di pioppo e olmo (stagionato "naturalmente" per almeno 3 anni) con elementi in multistrato di pioppo; giunzioni a incastro con spine cilindriche. Il molleggio è garantito da cinghie elastiche in polipropilene e lattice naturale. L'imbottitura della struttura è ottenuta con lastre di poliuretano espanso indeformabile a densità differenziate (30÷35 kg/m³) esente da CFC ricoperto da ovatta poliestere e vellutino accoppiato.

Cuscini. Cuscini di seduta disponibili in 3 tipologie: a) divisi in 3 camere orizzontali: le due esterne sono in piuma canalizzata mentre nella centrale c'è una lastra di poliuretano (40 kg/m³); b) completamente in poliuretano espanso a densità differenziate; c) in poliuretano espanso con parte frontale superiore del cuscino in Rollofill®. I cuscini di schienale sono completamente in piuma canalizzata. I cuscini di schienale e di seduta sono disponibili anche con bordo a palloncino.

Base. Piedini in tubolare d'acciaio. Disponibili in finitura cromata o verniciata a polveri epossidiche in colore RAL a scelta.

Rivestimento. Disponibile in tessuto e pelle; sfoderabile solo nella versione in tessuto.

Piani. I piani di tavolini e consolle sono disponibili esclusivamente in cuoio.

Frame. In solid poplar or elm heartwood ("naturally" seasoned for at least 3 years) with connecting elements in poplar plywood; dap joints with cylindrical dowels. The webbing is secured by elastic polypropylene and natural latex belts. The framework is upholstered with contoured sheets of resilient, CFC-free polyurethane foam (with density of 30÷35 kg/m³) covered by polyester wadding and bonded plush.

Cushions. The seat cushions are available in 3 different kinds: a) subdivided in 3 horizontal units: the two outside units are feather filled while in the central one there is a sheet of polyurethane foam (40 kg/m³); b) completely in polyurethane foam with different density; c) in polyurethane foam with front and upper part in Rollofill®. The back cushions are always feather-filled. The seat and back cushions are also available with piping.

Base. Supports in tubular steel. Available chromed or epoxy powder painted in RAL colors of your choice.

Covers. Available in fabric or leather; removable covers only for fabric version.

Top. Top of low tables and consoles are available only covered in saddle leather.

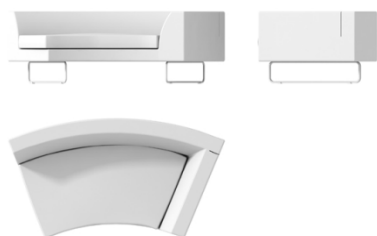

ADLOOKTECURDX

- I Terminale curvo con bracciolo destro.
- E Round terminal unit with right arm.
- F Élément terminal rond avec accoudoir droit.
- D Rundes Element mit rechter Armlehne.
- S Módulo terminal curvo con brazo derecho.

cm. 197 x 108 x h 65 – hs 42 • mt. 7.70
in. 77 1/2 x 42 1/2 x h 25 3/8 – hs 16 1/2 • yd. 8.42

COM	2.976,00
L	3.131,00
T	3.319,00
S	3.474,00
Z	3.662,00
K	3.818,00
PS	4.577,00
PF	5.126,00
PX	6.818,00
PA	7.793,00

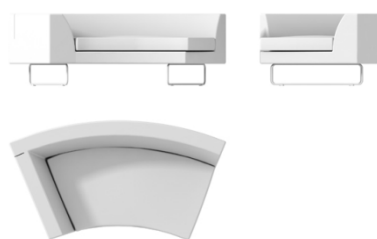

ADLOOKTECURSX

- I Terminale curvo con bracciolo sinistro.
- E Round terminal unit with left arm.
- F Élément terminal rond avec accoudoir gauche.
- D Rundes Element mit linker Armlehne.
- S Módulo terminal curvo con brazo izquierdo.

cm. 197 x 108 x h 65 – hs 42 • mt. 7.70
in. 77 1/2 x 42 1/2 x h 25 3/8 – hs 16 1/2 • yd. 8.42

COM	2.976,00
L	3.131,00
T	3.319,00
S	3.474,00
Z	3.662,00
K	3.818,00
PS	4.577,00
PF	5.126,00
PX	6.818,00
PA	7.793,00

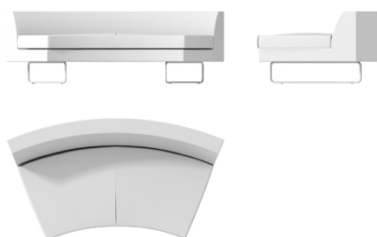

ADLOOKCENCURV

- I Elemento centrale curvo.
- E Central round unit.
- F Élément central rond.
- D Zentral runde Element.
- S Módulo central curvo.

cm. 197 x 108 x h 65 – hs 42 • mt. 7.80
in. 77 1/2 x 42 1/2 x h 25 3/8 – hs 16 1/2 • yd. 8.53

COM	2.812,00
L	2.969,00
T	3.138,00
S	3.318,00
Z	3.507,00
K	3.666,00
PS	4.436,00
PF	4.993,00
PX	6.690,00
PA	7.680,00









ADD_LOOK ROUND - Design Mauro Lipparini

	<p>ADLOOKPECURDX</p> <p>I Dormeuse tonda destra. E Right round chaiselongue unit. F Dormeuse ronde droite. D Rechte runde Dormeuse. S Chaise longue curva derecha.</p>	<p>COM 2.698,00 L 2.840,00 T 3.011,00 S 3.153,00 Z 3.325,00 K 3.467,00 PS 4.191,00 PF 4.695,00 PX 6.360,00 PA 7.274,00</p>
<p>cm. 197 x 108 x h 65 – hs 42 • mt. 7.00 in. 77”½ x 42”½ x h 25”½ – hs 16”½ • yd. 7.65</p>		
	<p>ADLOOKPECURSX</p> <p>I Dormeuse tonda sinistra. E Left round chaiselongue unit. F Dormeuse ronde gauche. D Linke runde Dormeuse. S Chaise longue curva izquierda.</p>	<p>COM 2.698,00 L 2.840,00 T 3.011,00 S 3.153,00 Z 3.325,00 K 3.467,00 PS 4.191,00 PF 4.695,00 PX 6.360,00 PA 7.274,00</p>
<p>cm. 197 x 108 x h 65 – hs 42 • mt. 7.00 in. 77”½ x 42”½ x h 25”½ – hs 16”½ • yd. 7.65</p>		
	<p>ADLOOKPOUCURV</p> <p>I Pouff tondo cm. 101x96. E Round ottoman cm. 101x96 F Pouff ronde cm.101x96 D Runde Hocker cm. 101x96 S Pouff curvo cm. 101x96.</p>	<p>COM 1.304,00 L 1.388,00 T 1.489,00 S 1.575,00 Z 1.676,00 K 1.760,00 PS 2.109,00 PF 2.422,00 PX 3.101,00 PA 3.616,00</p>
<p>cm. 101 x 100 x h 42 – hs 42 • mt. 4.20 in. 39”¾ x 39”¾ x h 16”½ – hs 16”½ • yd. 4.59</p>		
	<p>ADLOOKTAVCURV</p> <p>I Tavolino imbottito cm. 101x96, con piano in acciaio lucido. E Upholstered coffee table cm. 101x96, with top in polished steel. F Table basse avec structure rembourrée et plan en acier poli cm. 101x96. D Gepolstert Tisch cm. 101x96 mit Glaezendstahlplatte. S Mesa centro cm. 101x96 con tapa en acero.</p>	<p>COM 950,00 L 981,00 T 1.019,00 S 1.050,00 Z 1.087,00 K 1.119,00 PS 1.264,00 PF 1.379,00 PX 1.629,00 PA 1.820,00</p>
<p>cm. 101 x 100 x h 33 • mt. 1.65 in. 39”¾ x 39”¾ x h 13” • yd. 1.80</p>		
	<p>ADLOOKTECUDXR</p> <p>I Terminale curvo rovescio con bracciolo destro. E Round reverse terminal unit with right arm. F Élément terminal rond revers avec accoudoir droit. D Verkehrtes rundes Element mit rechter Armlehne. S Módulo terminal curvo con brazo derecho al otro lado.</p>	<p>COM 2.852,00 L 3.010,00 T 3.200,00 S 3.358,00 Z 3.547,00 K 3.706,00 PS 4.548,00 PF 5.127,00 PX 6.390,00 PA 7.346,00</p>
<p>cm. 197 x 108 x h 65 – hs 42 • mt. 7.90 in. 77”½ x 42”½ x h 25”½ – hs 16”½ • yd. 8.63</p>		
	<p>ADLOOKTECUSXR</p> <p>I Terminale curvo rovescio con bracciolo sinistro. E Round reverse terminal unit with left arm. F Élément terminal rond revers avec accoudoir gauche. D Verkehrtes rundes Element mit linker Armlehne. S Módulo terminal curvo con brazo izquierdo al otro lado.</p>	<p>COM 2.852,00 L 3.010,00 T 3.200,00 S 3.358,00 Z 3.547,00 K 3.706,00 PS 4.548,00 PF 5.127,00 PX 6.390,00 PA 7.346,00</p>
<p>cm. 197 x 108 x h 65 – hs 42 • mt. 7.90 in. 77”½ x 42”½ x h 25”½ – hs 16”½ • yd. 8.63</p>		

ADD_LOOK ROUND - Design Mauro Lipparini

	<p>ADLOOKCENCURO</p> <p>I Elemento centrale curvo rovescio. E Central round reverse unit. F Élément central rond revers. D Zentral runde Element verkehrt. S Módulo central curvo al otro lado.</p>	<p>COM 2.557,00 L 2.707,00 T 2.886,00 S 3.034,00 Z 3.214,00 K 3.363,00 PS 4.162,00 PF 4.706,00 PX 5.885,00 PA 6.782,00</p>
<p>cm. 197 x 108 x h 65 – hs 42 • mt. 7.45 in. 77”½ x 42”½ x h 25”½ – hs 16”½ • yd. 8.14</p>		
	<p>ADLOOKSCHANGO</p> <p>I Cuscino cm. 50x47. E Pillow cm. 50x47. F Coussin cm. 50x47. D Kissen cm. 50x47. S Cojín cm. 50x47.</p>	<p>COM 171,00 L 182,00 T 195,00 S 205,00 Z 218,00 K 229,00 PS 281,00 PF 319,00 PX 406,00 PA 469,00</p>
<p>cm. 50 x 47 x h 20 • mt. 0.70 in. 19”¾ x 18”½ x h 7”¾ • yd. 0.76</p>		
	<p>ADLOOKSCHP050</p> <p>I Cuscino con piping cm. 50x47. E Pillow with piping cm. 50x47. F Coussin avec passepoil cm. 50x47. D Kissen mit Keder cm. 50x47. S Cojín con perfil cm. 50x47.</p>	<p>COM 215,00 L 229,00 T 245,00 S 259,00 Z 275,00 K 288,00 PS 351,00 PF 397,00 PX 469,00 PA 538,00</p>
<p>cm. 50 x 47 x h 20 • mt. 0.70 in. 19”¾ x 18”½ x h 7”¾ • yd. 0.76</p>		
	<p>ADLOOKSCHD2PO</p> <p>I Cuscino cm. 67x47. E Pillow cm. 67x47. F Coussin cm. 67x47. D Kissen cm. 67x47. S Cojín cm. 67x47.</p>	<p>COM 203,00 L 219,00 T 239,00 S 255,00 Z 276,00 K 293,00 PS 355,00 PF 411,00 PX 533,00 PA 624,00</p>
<p>cm. 67 x 47 x h 20 • mt. 0.85 in. 26”¾ x 18”½ x h 7”¾ • yd. 0.93</p>		
	<p>ADLOOKSCHP067</p> <p>I Cuscino con piping cm. 67x47. E Pillow with piping cm. 67x47. F Coussin avec passepoil cm. 67x47. D Kissen mit Keder cm. 67x47. S Cojín con perfil cm. 67x47.</p>	<p>COM 269,00 L 289,00 T 314,00 S 335,00 Z 358,00 K 379,00 PS 440,00 PF 499,00 PX 571,00 PA 659,00</p>
<p>cm. 67 x 47 x h 20 • mt. 0.85 in. 26”¾ x 18”½ x h 7”¾ • yd. 0.93</p>		
	<p>ADLOOKSCH2PGR</p> <p>I Cuscino cm. 81x47. E Pillow cm. 81x47. F Coussin cm. 81x47. D Kissen cm. 81x47. S Cojín cm. 81x47.</p>	<p>COM 224,00 L 244,00 T 268,00 S 287,00 Z 312,00 K 332,00 PS 387,00 PF 450,00 PX 588,00 PA 692,00</p>
<p>cm. 81 x 47 x h 20 • mt. 1.00 in. 31”¾ x 18”½ x h 7”¾ • yd. 1.09</p>		

ADD_LOOK ROUND - Design Mauro Lipparini

 	<p>ADLOOKSCHP081</p> <p>I Cuscino con piping cm. 81x47. E Pillow with piping cm. 81x47. F Coussin avec passepoil cm. 81x47. D Kissen mit Keder cm. 81x47. S Cojín con perfil cm. 81x47.</p> <p>cm. 81 x 47 x h 20 • mt. 1.00 in. 31”½ x 18”½ x h 7”½ • yd. 1.09</p>	COM	301,00
		L	325,00
		T	355,00
		S	380,00
		Z	410,00
		K	435,00
		PS	497,00
		PF	565,00
		PX	675,00
		PA	777,00
 	<p>ADLOOKSCHD3PO</p> <p>I Cuscino cm. 97x47. E Pillow cm. 97x47. F Coussin cm. 97x47. D Kissen cm. 97x47. S Cojín cm. 97x47.</p> <p>cm. 97 x 47 x h 20 • mt. 1.20 in. 38”¼ x 18”½ x h 7”½ • yd. 1.31</p>	COM	250,00
		L	274,00
		T	302,00
		S	325,00
		Z	353,00
		K	377,00
		PS	476,00
		PF	559,00
		PX	694,00
		PA	821,00
 	<p>ADLOOKSCHP097</p> <p>I Cuscino con piping cm. 97x47. E Pillow with piping cm. 97x47. F Coussin avec passepoil cm. 97x47. D Kissen mit Keder cm. 97x47. S Cojín con perfil cm. 97x47.</p> <p>cm. 97 x 47 x h 20 • mt. 1.20 in. 38”¼ x 18”½ x h 7”½ • yd. 1.31</p>	COM	320,00
		L	347,00
		T	380,00
		S	407,00
		Z	440,00
		K	468,00
		PS	541,00
		PF	618,00
		PX	742,00
		PA	857,00
 	<p>ADLOOKCUSCINE</p> <p>I Cuscino cm. 50x40. E Pillow cm. 50x40. F Coussin cm. 50x40. D Kissen cm. 50x40. S Cojín cm. 50x40.</p> <p>cm. 50 x 40 x h 10 • mt. 0.70 in. 19”¾ x 15”¾ x h 7”¾ • yd. 0.76</p>	COM	123,00
		L	136,00
		T	152,00
		S	166,00
		Z	181,00
		K	195,00
		PS	209,00
		PF	247,00
		PX	334,00
		PA	397,00
	<p>ADLOOKPIEDJHO</p> <p>I Supplemento per piedini cromati neri come modello "Joshua" per ogni elemento di seduta. E Extra charge for black chromed feet as "Joshua" model for each seat element. F Supplément pour pieds chromés noirs comme modèle "Joshua" pour chaque élément d'assise. D Mehrpreis für schwarze Chromfüße wie "Joshua" Modell für jedes Sitzelement. S Suplemento para pies de cromo negro como modelo "Joshua" para cada elemento del asiento.</p>		216,00

BE_LOOK - Design Mauro Lipparini



Struttura. In legno massello di pioppo e olmo (stagionato "naturalmente" per almeno 3 anni) con elementi in multistrato di pioppo; giunzioni a incastro con spine cilindriche. Il molleggio è garantito da cinghie elastiche in polipropilene e lattice naturale. L'imbottitura della struttura è ottenuta con lastre di poliuretano espanso indeformabile a densità differenziate (30÷35 kg/m³) esente da CFC ricoperto da ovatta poliestere e vellutino accoppiato.

Cuscini. I cuscini di schienale sono completamente in piuma canalizzata e sono disponibili anche con bordo a palloncino.

Base. Piedini in tubolare d'acciaio. Disponibili in finitura cromata o verniciata a polveri epossidiche in colore RAL a scelta.

Rivestimento. Disponibile in tessuto e pelle; sfoderabile solo nella versione in tessuto.

Frame. In solid poplar or elm heartwood ("naturally" seasoned for at least 3 years) with connecting elements in poplar plywood; dap joints with cylindrical dowels. The webbing is secured by elastic polypropylene and natural latex belts. The framework is upholstered with contoured sheets of resilient, CFC-free polyurethane foam (with density of 30÷35 kg/m³) covered by polyester wadding and bonded plush.

Cushions. The back cushions are always feather-filled and are available also with piping.

Base. Supports in tubular steel. Available chromed or epoxy powder painted in RAL colors of your choice.

Covers. Available in fabric or leather; removable covers only for fabric version.



BELOOKCENTRAL

- I Elemento centrale cm. 96, profondità cm. 96.
- E Central unit cm. 96, depth cm. 96.
- F Élément central cm. 96, profondeur cm. 96.
- D Zentral Element cm. 96, Tiefe cm. 96.
- S Parte central cm. 96, profundidad cm. 96.

cm. 96 x 96 x h 65 – hs 40 • mt. 4.40
in. 37³/₄ x 37³/₄ x h 25³/₄ – hs 15³/₄ • yd. 4.81

COM	1.514,00
L	1.607,00
T	1.718,00
S	1.784,00
Z	1.922,00
K	2.015,00
PS	2.426,00
PF	2.755,00
PX	3.477,00
PA	4.022,00

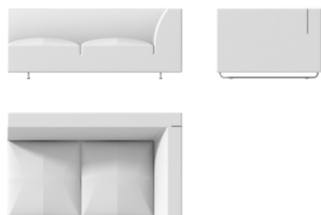

BELOOKDV2PIDX

- I Divano 2 posti con bracciolo destro cm. 158.
- E 2 seater sofa with right arm cm. 158.
- F Canapé 2 places avec accoudoir droit cm. 158.
- D Sofa 2-sitzig mit rechter Armlehne cm. 158.
- S Sofá de 2 plazas con brazo derecho cm. 158.

cm. 158 x 96 x h 65 – hs 40 • mt. 5.20
in. 62³/₄ x 37³/₄ x h 25³/₄ – hs 15³/₄ • yd. 5.68

COM	1.997,00
L	2.101,00
T	2.226,00
S	2.329,00
Z	2.453,00
K	2.557,00
PS	3.074,00
PF	3.441,00
PX	4.249,00
PA	4.856,00

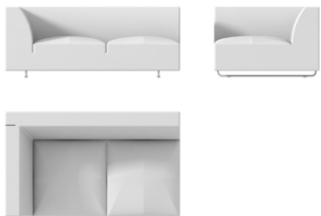

BELOOKDV2PISX

- I Divano 2 posti con bracciolo sinistro cm. 158.
- E 2 seater sofa with left arm cm. 158.
- F Canapé 2 places avec accoudoir gauche cm. 158.
- D Sofa 2-sitzig mit linker Armlehne cm. 158.
- S Sofá de 2 plazas con brazo izquierdo cm. 158.

cm. 158 x 96 x h 65 – hs 40 • mt. 5.20
in. 62³/₄ x 37³/₄ x h 25³/₄ – hs 15³/₄ • yd. 5.68

COM	1.997,00
L	2.101,00
T	2.226,00
S	2.329,00
Z	2.453,00
K	2.557,00
PS	3.074,00
PF	3.441,00
PX	4.249,00
PA	4.856,00

BE_LOOK - Design Mauro Lipparini

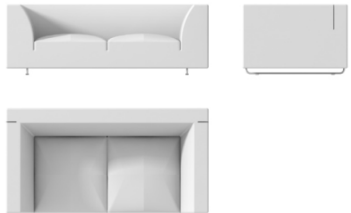
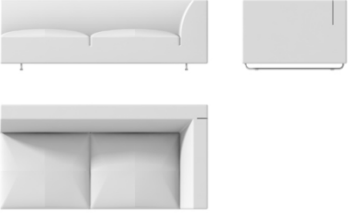
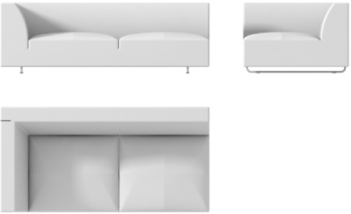
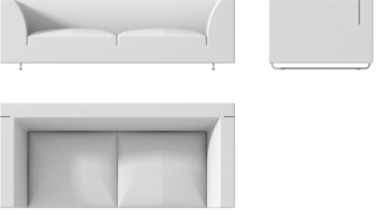
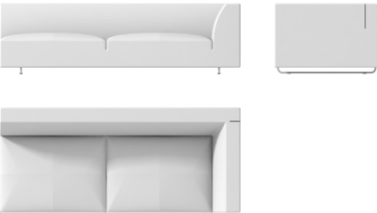
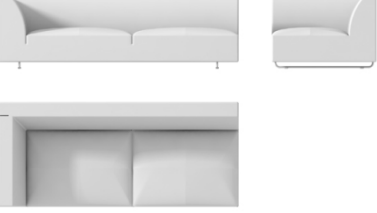
	<p>BELOOKDIVA2PI</p> <p>I Divano 2 posti cm. 183. E 2 seater sofa cm. 183. F Canapé 2 places cm. 183. D Sofa 2-sitzig cm. 183. S Sofá de 2 plazas cm. 183.</p>	<p>COM 2.299,00 L 2.413,00 T 2.551,00 S 2.666,00 Z 2.804,00 K 2.918,00 PS 3.512,00 PF 3.919,00 PX 4.795,00 PA 5.463,00</p>
	<p>BELOOKDV2GRDX</p> <p>I Divano 2 posti con bracciolo destro cm. 188. E 2 seater sofa with right arm cm. 188. F Canapé 2 places avec accoudoir droit cm. 188. D Sofa 2-sitzig mit rechter Armlehne cm. 188. S Sofá de 2 plazas con brazo derecho cm. 188.</p>	<p>COM 2.228,00 L 2.347,00 T 2.491,00 S 2.609,00 Z 2.752,00 K 2.872,00 PS 3.473,00 PF 3.895,00 PX 4.821,00 PA 5.520,00</p>
	<p>BELOOKDV2GRSX</p> <p>I Divano 2 posti con bracciolo sinistro cm. 188. E 2 seater sofa with left arm cm. 188. F Canapé 2 places avec accoudoir gauche cm. 188. D Sofa 2-sitzig mit linker Armlehne cm. 188. S Sofá de 2 plazas con brazo izquierdo cm. 188.</p>	<p>COM 2.228,00 L 2.347,00 T 2.491,00 S 2.609,00 Z 2.752,00 K 2.872,00 PS 3.473,00 PF 3.895,00 PX 4.821,00 PA 5.520,00</p>
	<p>BELOOKDIVA2GR</p> <p>I Divano 2 posti cm. 213. E 2 seater sofa cm. 213. F Canapé 2 places cm. 213. D Sofa 2-sitzig cm. 213. S Sofá de 2 plazas cm. 213.</p>	<p>COM 2.513,00 L 2.641,00 T 2.794,00 S 2.922,00 Z 3.077,00 K 3.204,00 PS 3.855,00 PF 4.310,00 PX 5.298,00 PA 6.047,00</p>
	<p>BELOOKDIVA3DX</p> <p>I Divano 3 posti con bracciolo destro. E 3 seater sofa with right arm. F Canapé 3 places avec accoudoir droit. D Sofa 3-sitzig mit rechter Armlehne. S Sofá de 3 plazas con brazo derecho.</p>	<p>COM 2.436,00 L 2.566,00 T 2.722,00 S 2.852,00 Z 3.009,00 K 3.138,00 PS 3.774,00 PF 4.235,00 PX 5.243,00 PA 6.005,00</p>
	<p>BELOOKDIVA3SX</p> <p>I Divano 3 posti con bracciolo sinistro. E 3 seater sofa with left arm. F Canapé 3 places avec accoudoir gauche. D Sofa 3-sitzig mit linker Armlehne. S Sofá de 3 plazas con brazo izquierdo.</p>	<p>COM 2.436,00 L 2.566,00 T 2.722,00 S 2.852,00 Z 3.009,00 K 3.138,00 PS 3.774,00 PF 4.235,00 PX 5.243,00 PA 6.005,00</p>

BE_LOOK - Design Mauro Lipparini



BELOOKDIVA3PO

I Divano 3 posti.
E 3 seater sofa.
F Canapé 3 places.
D Sofa 3-sitzig.
S Sofá de 3 plazas.

cm. 243 x 96 x h 65 – hs 40 • mt. 7.00
in. 95”% x 37”% x h 25”% – hs 15”% • yd. 7.65

COM	2.677,00
L	2.818,00
T	2.987,00
S	3.129,00
Z	3.298,00
K	3.439,00
PS	4.170,00
PF	4.671,00
PX	5.760,00
PA	6.585,00

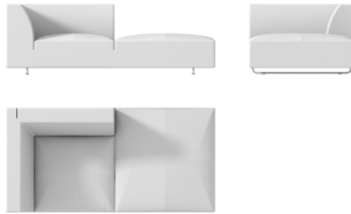

BELOOKDORMEDX

I Dormeuse angolare destra.
E Right angular chaiselongue.
F Dormeuse angulaire droite.
D Rechte winkelige Dormeuse.
S Chaise longue con rincón derecho.

cm. 188 x 96 x h 65 – hs 40 • mt. 5.85
in. 74” x 37”% x h 25”% – hs 15”% • yd. 6.39

COM	2.020,00
L	2.136,00
T	2.276,00
S	2.394,00
Z	2.534,00
K	2.651,00
PS	3.160,00
PF	3.575,00
PX	4.482,00
PA	5.166,00

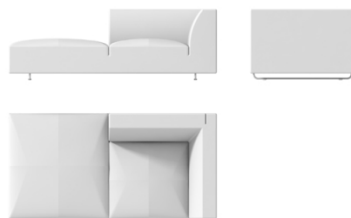

BELOOKDORMESX

I Dormeuse anfolare sinistra.
E Left angular chaiselongue.
F Dormeuse angulaire gauche.
D Linke winkelige Dormeuse.
S Chaise longue con rincón izquierdo.

cm. 188 x 96 x h 65 – hs 40 • mt. 5.85
in. 74” x 37”% x h 25”% – hs 15”% • yd. 6.39

COM	2.020,00
L	2.136,00
T	2.276,00
S	2.394,00
Z	2.534,00
K	2.651,00
PS	3.160,00
PF	3.575,00
PX	4.482,00
PA	5.166,00

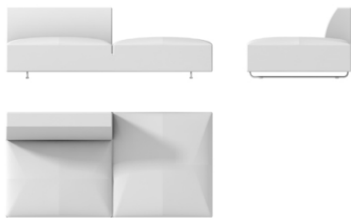

BELOOKPENISDX

I Dormeuse lineare destra.
E Right linear chaiselongue.
F Dormeuse linéaire droite.
D Rechte lineare Dormeuse.
S Chaise longue lineal derecha.

cm. 188 x 96 x h 65 – hs 40 • mt. 5.70
in. 74” x 37”% x h 25”% – hs 15”% • yd. 6.23

COM	1.799,00
L	1.914,00
T	2.052,00
S	2.166,00
Z	2.304,00
K	2.418,00
PS	3.040,00
PF	3.315,00
PX	4.203,00
PA	4.875,00

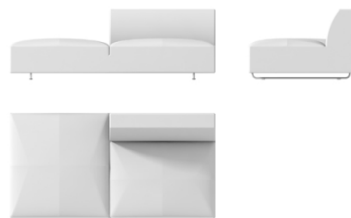

BELOOKPENISSX

I Dormeuse lineare sinistra.
E Left linear chaiselongue.
F Dormeuse linéaire gauche.
D Linke lineare Dormeuse.
S Chaise longue lineal izquierda.

cm. 188 x 96 x h 65 – hs 40 • mt. 5.70
in. 74” x 37”% x h 25”% – hs 15”% • yd. 6.23

COM	1.799,00
L	1.914,00
T	2.052,00
S	2.166,00
Z	2.304,00
K	2.418,00
PS	3.040,00
PF	3.315,00
PX	4.203,00
PA	4.875,00



BELOOKPOU9565

I Pouf cm. 95x65.
E Ottoman cm. 95x65.
F Pouf cm. 95x65.
D Hocker cm. 95x65.
S Pouf cm. 95x65.





cm. 96 x 68 x h 40 – hs 40 • mt. 2.20
in. 37”% x 26”% x h 15”% – hs 15”% • yd. 2.40

COM	919,00
L	963,00
T	1.017,00
S	1.061,00
Z	1.113,00
K	1.158,00
PS	1.337,00
PF	1.494,00
PX	1.831,00
PA	2.089,00

BE_LOOK - Design Mauro Lipparini

	<p>BELOOKPOU9595</p> <p>I Pouf cm. 95x95. E Ottoman cm. 95x95. F Pouf cm. 95x95. D Hocker cm. 95x95. S Pouf cm. 95x95.</p>	<p>COM 1.002,00 L 1.058,00 T 1.124,00 S 1.179,00 Z 1.245,00 K 1.300,00 PS 1.517,00 PF 1.713,00 PX 2.144,00 PA 2.469,00</p>
<p>cm. 96 x 96 x h 40 – hs 40 • mt. 2.75 in. 37³/₄ x 37³/₄ x h 15³/₄ – hs 15³/₄ • yd. 3.00</p>	<p>COM 1.673,00 L 1.737,00 T 1.814,00 S 1.878,00 Z 1.955,00 K 2.020,00 PS 2.267,00 PF 2.529,00 PX 3.023,00 PA 3.414,00</p>	
	<p>BELOOKPU19095</p> <p>I Pouf cm. 190x95. E Ottoman cm. 190x95. F Pouf cm. 190x95. D Hocker cm. 190x95. S Pouf cm. 190x95.</p>	<p>cm. 190 x 96 x h 40 – hs 40 • mt. 3.30 in. 74³/₄ x 37³/₄ x h 15³/₄ – hs 15³/₄ • yd. 3.60</p>
	<p>ADLOOKSCHANGO</p> <p>I Cuscino cm. 50x47. E Pillow cm. 50x47. F Coussin cm. 50x47. D Kissen cm. 50x47. S Cojín cm. 50x47.</p>	<p>COM 171,00 L 182,00 T 195,00 S 205,00 Z 218,00 K 229,00 PS 281,00 PF 319,00 PX 406,00 PA 469,00</p>
<p>cm. 50 x 47 x h 20 • mt. 0.70 in. 19³/₄ x 18³/₄ x h 7³/₄ • yd. 0.76</p>	<p>COM 215,00 L 229,00 T 245,00 S 259,00 Z 275,00 K 288,00 PS 351,00 PF 397,00 PX 469,00 PA 538,00</p>	
	<p>ADLOOKSCHP050</p> <p>I Cuscino con piping cm. 50x47. E Pillow with piping cm. 50x47. F Coussin avec passepoil cm. 50x47. D Kissen mit Keder cm. 50x47. S Cojín con perfil cm. 50x47.</p>	<p>cm. 50 x 47 x h 20 • mt. 0.70 in. 19³/₄ x 18³/₄ x h 7³/₄ • yd. 0.76</p>
	<p>ADLOOKSCHD2PO</p> <p>I Cuscino cm. 67x47. E Pillow cm. 67x47. F Coussin cm. 67x47. D Kissen cm. 67x47. S Cojín cm. 67x47.</p>	<p>COM 203,00 L 219,00 T 239,00 S 255,00 Z 276,00 K 293,00 PS 355,00 PF 411,00 PX 533,00 PA 624,00</p>
<p>cm. 67 x 47 x h 20 • mt. 0.85 in. 26³/₄ x 18³/₄ x h 7³/₄ • yd. 0.93</p>	<p>COM 269,00 L 289,00 T 314,00 S 335,00 Z 358,00 K 379,00 PS 440,00 PF 499,00 PX 571,00 PA 659,00</p>	
	<p>ADLOOKSCHP067</p> <p>I Cuscino con piping cm. 67x47. E Pillow with piping cm. 67x47. F Coussin avec passepoil cm. 67x47. D Kissen mit Keder cm. 67x47. S Cojín con perfil cm. 67x47.</p>	<p>cm. 67 x 47 x h 20 • mt. 0.85 in. 26³/₄ x 18³/₄ x h 7³/₄ • yd. 0.93</p>

BE_LOOK - Design Mauro Lipparini

	<p>ADLOOKSCH2PGR</p> <p>I Cuscino cm. 81x47. E Pillow cm. 81x47. F Coussin cm. 81x47. D Kissen cm. 81x47. S Cojín cm. 81x47.</p> <p>cm. 81 x 47 x h 20 • mt. 1.00 in. 31⁷/₈ x 18¹/₂ x h 7⁷/₈ • yd. 1.09</p>	COM	224,00
		L	244,00
		T	268,00
		S	287,00
		Z	312,00
		K	332,00
		PS	387,00
		PF	450,00
		PX	588,00
		PA	692,00
	<p>ADLOOKSCHP081</p> <p>I Cuscino con piping cm. 81x47. E Pillow with piping cm. 81x47. F Coussin avec passepoil cm. 81x47. D Kissen mit Keder cm. 81x47. S Cojín con perfil cm. 81x47.</p> <p>cm. 81 x 47 x h 20 • mt. 1.00 in. 31⁷/₈ x 18¹/₂ x h 7⁷/₈ • yd. 1.09</p>	COM	301,00
		L	325,00
		T	355,00
		S	380,00
		Z	410,00
		K	435,00
		PS	497,00
		PF	565,00
		PX	675,00
		PA	777,00
	<p>ADLOOKSCHD3PO</p> <p>I Cuscino cm. 97x47. E Pillow cm. 97x47. F Coussin cm. 97x47. D Kissen cm. 97x47. S Cojín cm. 97x47.</p> <p>cm. 97 x 47 x h 20 • mt. 1.20 in. 38¹/₄ x 18¹/₂ x h 7⁷/₈ • yd. 1.31</p>	COM	250,00
		L	274,00
		T	302,00
		S	325,00
		Z	353,00
		K	377,00
		PS	476,00
		PF	559,00
		PX	694,00
		PA	821,00
	<p>ADLOOKSCHP097</p> <p>I Cuscino con piping cm. 97x47. E Pillow with piping cm. 97x47. F Coussin avec passepoil cm. 97x47. D Kissen mit Keder cm. 97x47. S Cojín con perfil cm. 97x47.</p> <p>cm. 97 x 47 x h 20 • mt. 1.20 in. 38¹/₄ x 18¹/₂ x h 7⁷/₈ • yd. 1.31</p>	COM	320,00
		L	347,00
		T	380,00
		S	407,00
		Z	440,00
		K	468,00
		PS	541,00
		PF	618,00
		PX	742,00
		PA	857,00
	<p>ADLOOKCUSCINE</p> <p>I Cuscino cm. 50x40. E Pillow cm. 50x40. F Coussin cm. 50x40. D Kissen cm. 50x40. S Cojín cm. 50x40.</p> <p>cm. 50 x 40 x h 10 • mt. 0.70 in. 19³/₈ x 15³/₈ x h 7⁷/₈ • yd. 0.76</p>	COM	123,00
		L	136,00
		T	152,00
		S	166,00
		Z	181,00
		K	195,00
		PS	209,00
		PF	247,00
		PX	334,00
		PA	397,00

COMPOSIZIONI

Di seguito potete trovare alcune delle infinite composizioni possibili dei modelli Add_Look e Be_look. Esse sono state ottenute combinando i diversi elementi dei divani (con due o un solo bracciolo), delle penisole, dei pouff e dei cuscini dello schienale secondo le diverse dimensioni degli stessi. Nelle pagine a seguire trovate:

- ◆ I disegni con le dimensioni di ingombro della composizione;
- ◆ Nell'angolo inferiore destro del riquadro che contiene il disegno della composizione ci sono due codici – nel caso in cui la composizione è disponibile sia per Add_Look che per Be_Look – oppure uno solo – nel caso in cui la composizione è disponibile solo per Add_Look. Esempio:
A001 = Codice della composizione per ADD_LOOK
B001 = Codice della composizione per BE_LOOK
- ◆ La lista dei prezzi nelle diverse categorie di tessuto e pelle per ogni singolo codice di composizione.

COMPOSITIONS

Following you can find some of the infinite possible composition of the models Add_Look and Be_Look. They have been obtained combining the different elements of the sofas (with two or only one arm), some chaise longue, some ottomans and back cushions belonging to the different dimensions of the same. In the following pages you find:

- ◆ The drawings with the overall dimensions of the composition;
- ◆ In the right lower corner of the square that contains the drawing of the composition there are two codes – in case that the composition is available either for Add_Look nor for Be_Look – or only one – in case that the composition is available only for Add_Look. Example:
A001 = Code of the composition for ADD_LOOK
B001 = Code of the composition for BE_LOOK
- ◆ The list of the prices in the different categories of fabric and leather for each single code of composition.

COMPOSITIONS

Vous pouvez trouver ci-joint quelques-unes parmi les possibles compositions des modèles Add_Look et Be_Look. Nous les avons obtenues en mettant ensemble des éléments différents (avec deux ou un seul accoudoir), des dormeuses, des poufs et les coussins de dossier en utilisant les différentes dimensions. Dans les pages suivantes vous trouvez donc:

- ◆ Les dessins avec les dimensions de la composition;
- ◆ Dans l'angle inférieur du carré qui contient le dessin, à droite, vous trouverez deux codes – si la composition est disponible pour Add_Look et Be_Look – ou bien un seul code – si la composition est disponible uniquement pour Add_Look. Par exemple:
A001 = Code de la composition pour ADD_LOOK
B001 = Code de la composition pour BE_LOOK
- ◆ La liste de prix dans les différentes catégories de tissu et cuir pour chaque composition.

ZUSAMMENSETZUNGEN

Hintereinander koennen Sie einige von den unendlichen moeglichen Zusammensetzungen von Modellen Add_Look und Be_Look finden. Sie waren erreicht zusammenstellend die verschiedene Elementen von Sofas (mit zwei oder nur einen Armlehne), einige Chaise Longue, Hocker und Ruckenkissen gemaess die verschiedene Masse von derselben. In die folgenden Seite finden Sie:

- ◆ Zeichnen mit Aussenmasse von der Zusammensetzung;
- ◆ Im unterem rechtem Winkel enthaltend Zeichnung vom Zusammensetzung, gibt es zwei Kode, eventuell die Zusammensetzung ist lieferbar entweder fuer Add_Look nur fuer Be_Look, oder nur einzige – eventuell die Zusammensetzung ist lieferbar nur fuer Add_Look. Beispiel:
A001 = Kode von der Zusammensetzung fuer ADD_LOOK
B001 = Kode von der Zusammensetzung fuer BE_LOOK
- ◆ Die Liste der Preisen in den verschiedene Stoff - Leder Kategorien fuer jeder einzige Kode von Zusammensetzung.

COMPOSICIONES

En las páginas siguientes, se pueden encontrar algunas de las infinitas composiciones posibles de los modelos Add_Look y Be_Look. Dichas composiciones derivan de la combinación de los diversos tipo de sofá (con 2 brazos, con 1 brazo, de las chaiselongue, de los cojines ect....) según las diferentes medidas.

En las páginas siguientes, se pueden encontrar :

- ◆ Los dibujos con las medidas
- ◆ En el rincón inferior derecho, cerca del dibujo, hay 2 códigos que identifican el modelo. Por ejemplo:
A001 = Código de la composición ADD_LOOK.
B001 = Código de la composición BE_LOOK.
- ◆ La lista de los precios en las diferentes categorías de tejido e de cuero, de las composiciones dibujadas.

ADD_LOOK & BE_LOOK - Design Mauro Lipparini

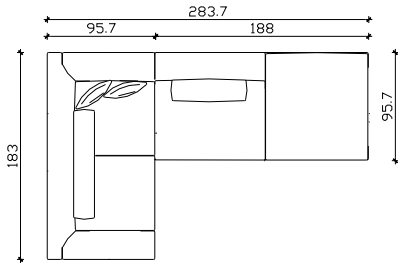

A001
B001

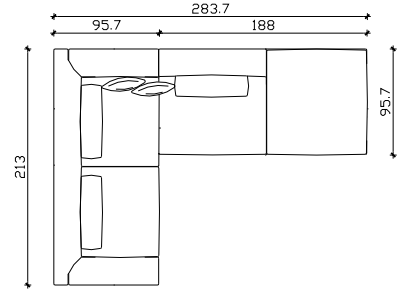

A002
B002

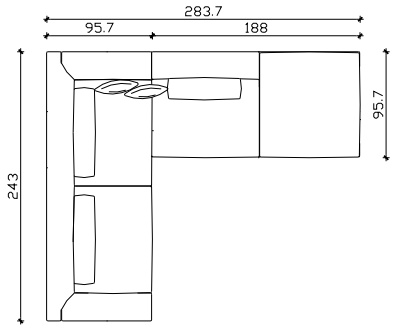

A003
B003

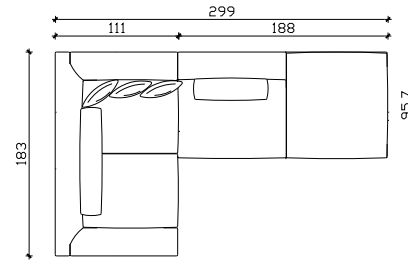

A004

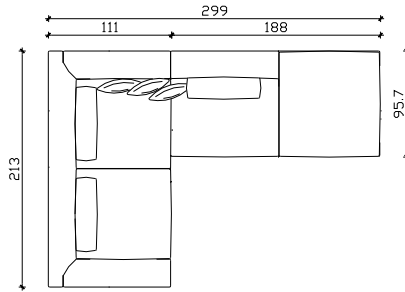

A005

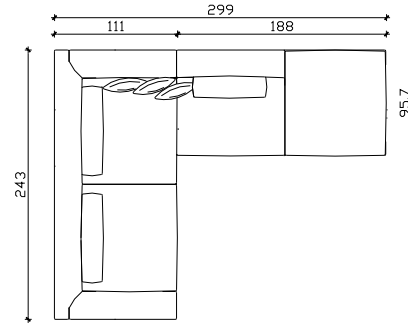

A006

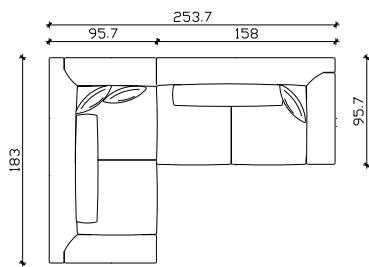

A007
B007

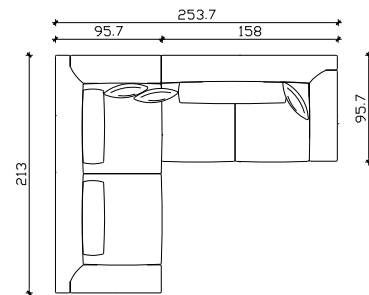

A008
B008

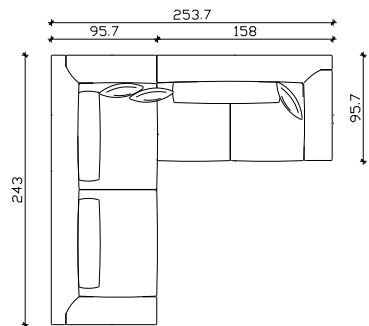

A009
B009

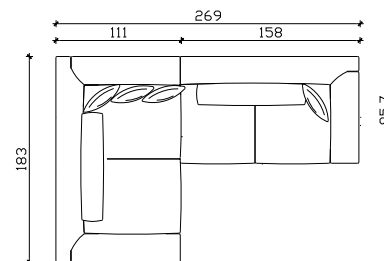

A010

ADD_LOOK & BE_LOOK - Design Mauro Lipparini

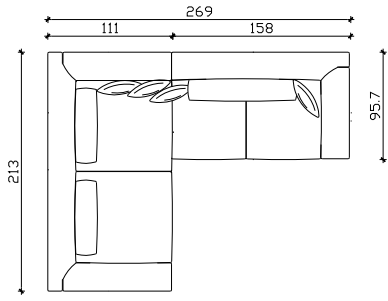

A011

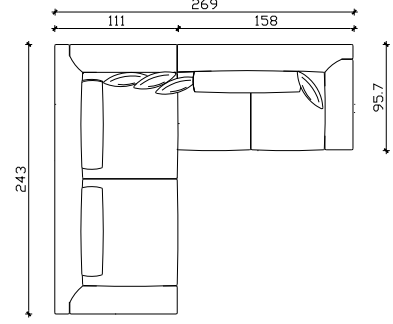

A012

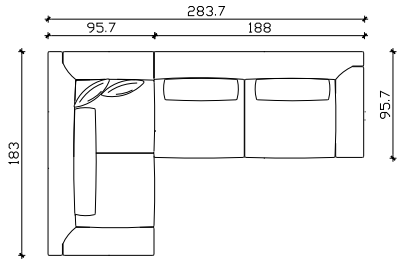

A013
B013

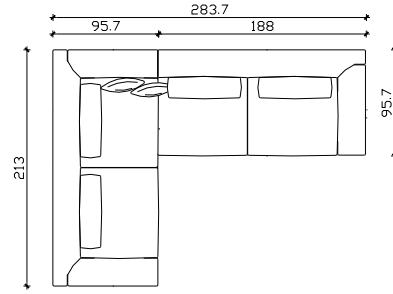

A014
B014

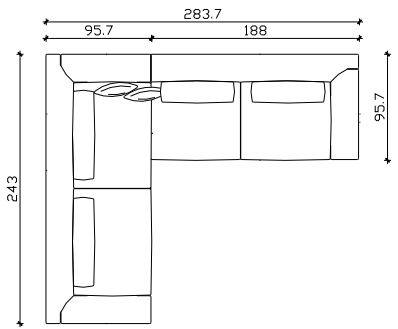

A015
B015

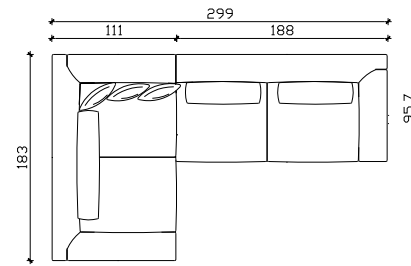

A016

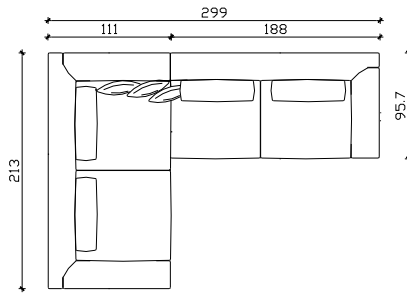

A017

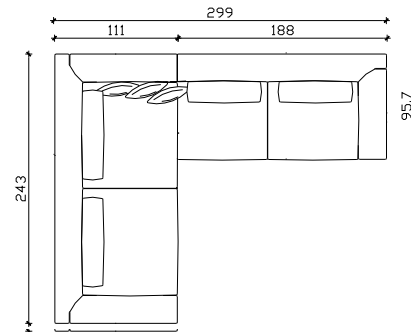

A018

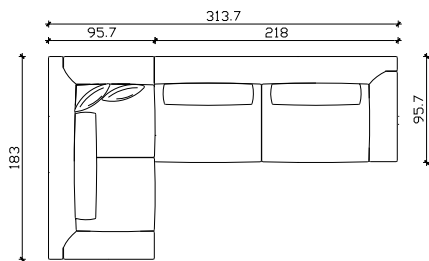

A019
B019

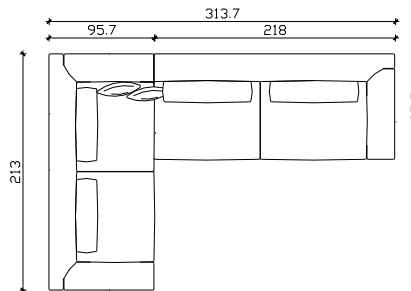

A020
B020

ADD_LOOK & BE_LOOK - Design Mauro Lipparini

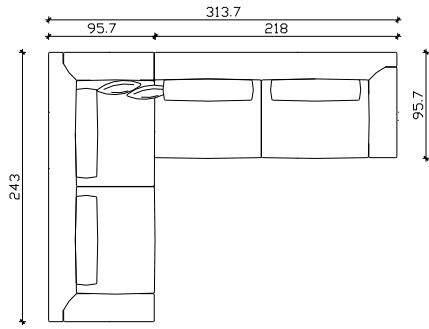

A021
B021

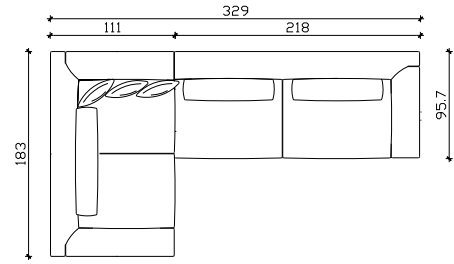

A022

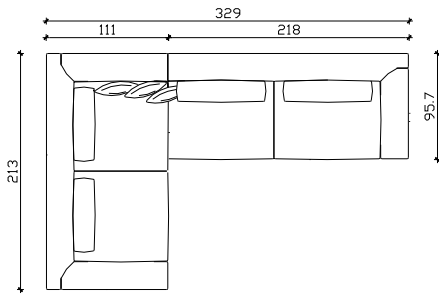

A023

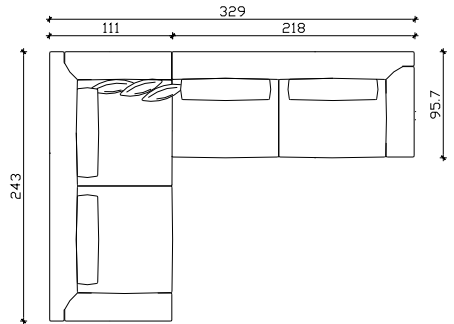

A024

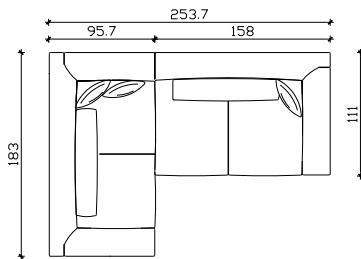

A025

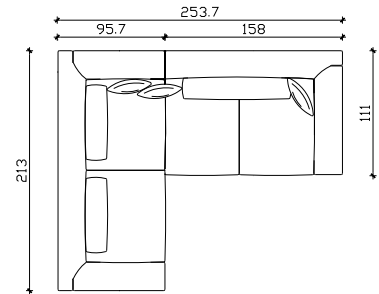

A026

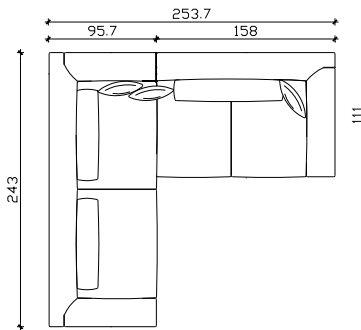

A027

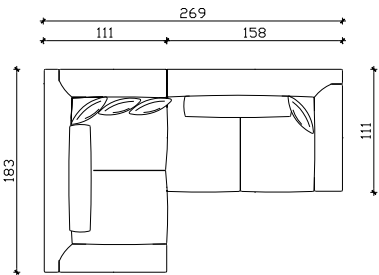

A028

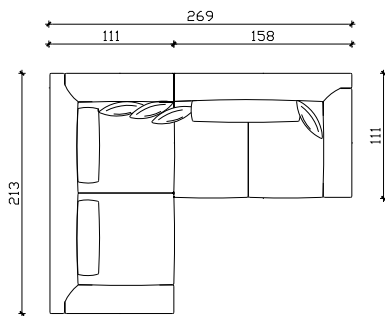

A029

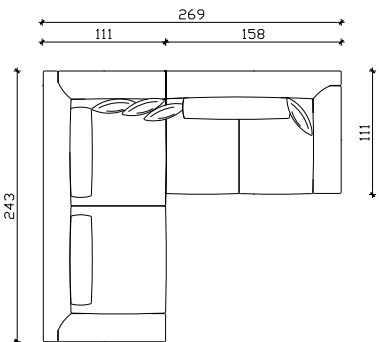

A030

ADD_LOOK & BE_LOOK - Design Mauro Lipparini

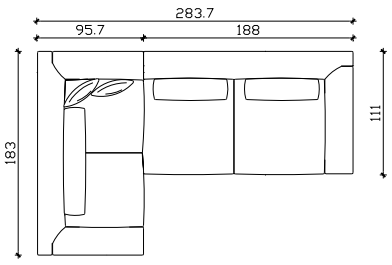

A031

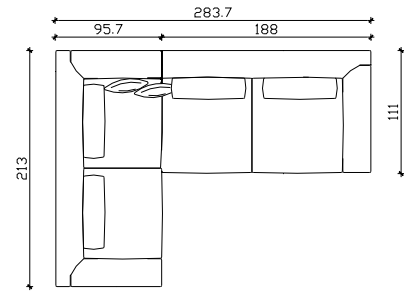

A032

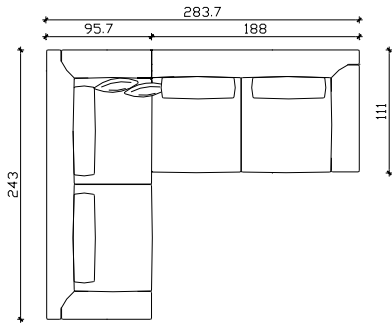

A033

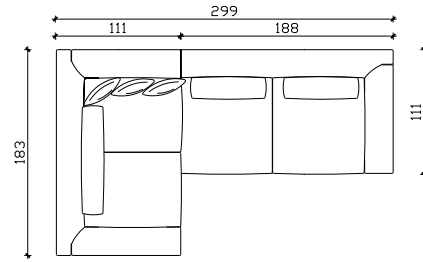

A034

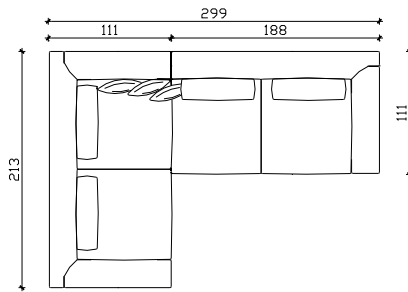

A035

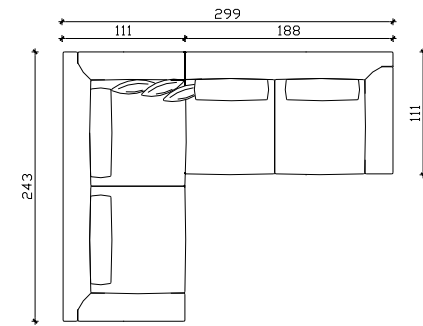

A036

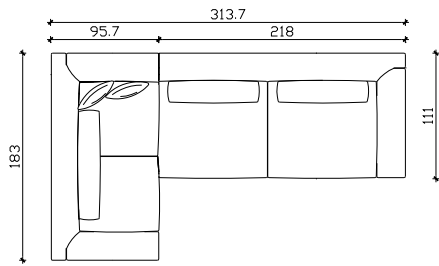

A037

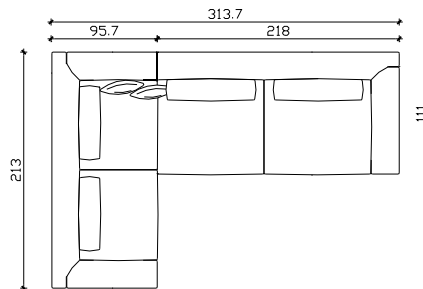

A038

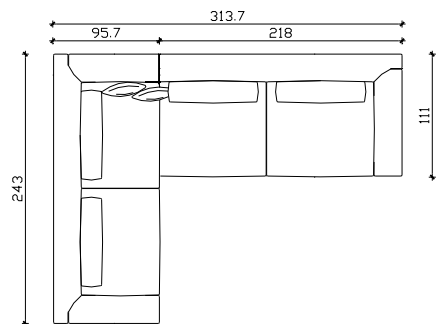

A039

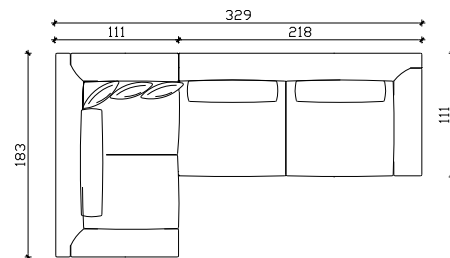

A040

ADD_LOOK & BE_LOOK - Design Mauro Lipparini

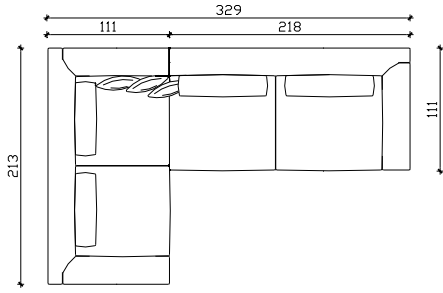

A041

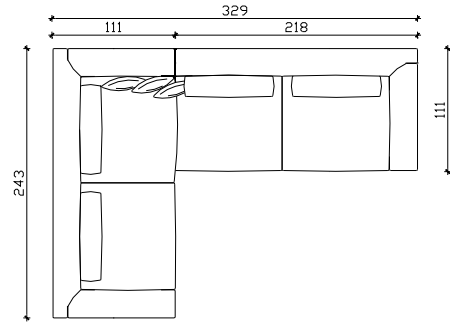

A042

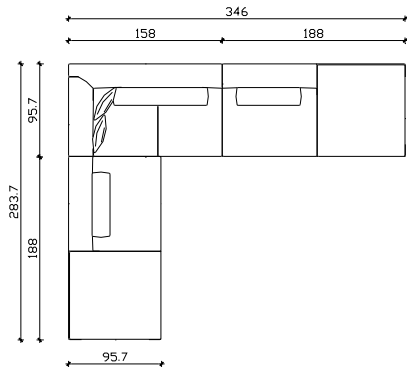

A079
B079

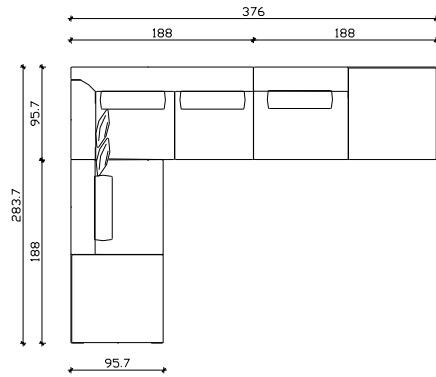

A080
B080

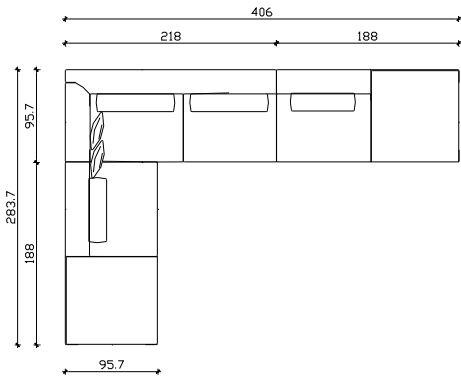

A081
B081

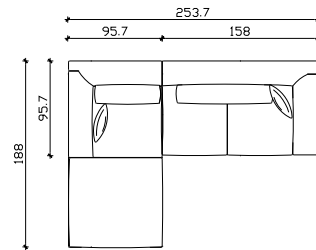

A088
B088

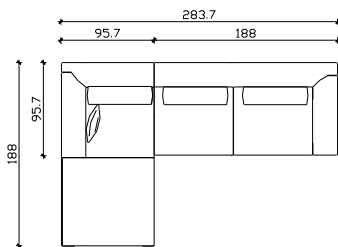

A089
B089

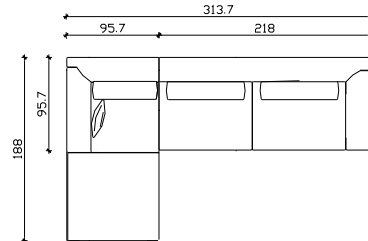

A090
B090

ADD_LOOK & BE_LOOK - Design Mauro Lipparini

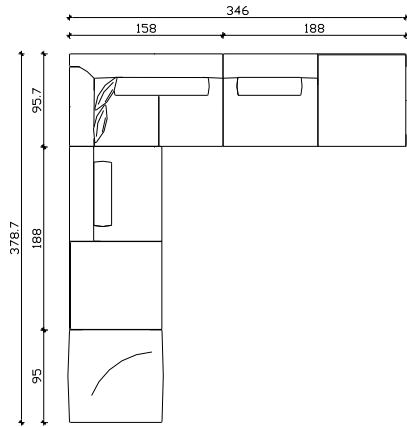

A097
 Pouff senza cuscino
 Ottoman without cushion
 Pouf sans coussin
 Hoker ohne Kissen
 Pouf sin cojin

B097

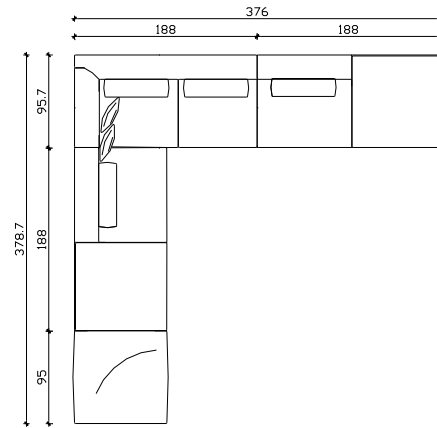

A098
 Pouff senza cuscino
 Ottoman without cushion
 Pouf sans coussin
 Hoker ohne Kissen
 Pouf sin cojin

B098

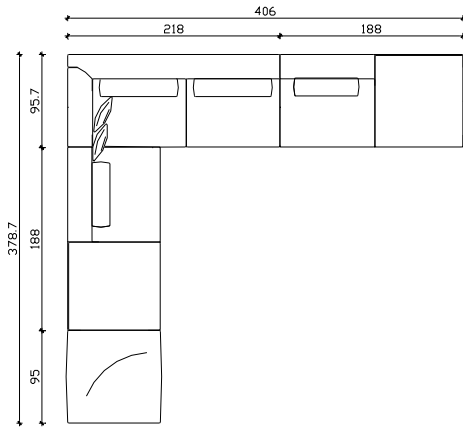

A099
 Pouff senza cuscino
 Ottoman without cushion
 Pouf sans coussin
 Hoker ohne Kissen
 Pouf sin cojin

B099

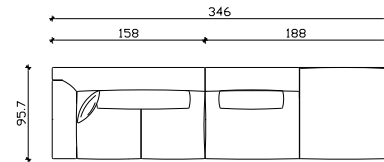

A179
B179

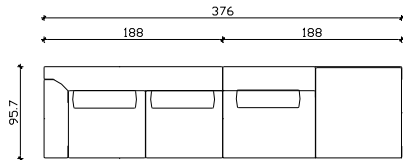

A180
B180

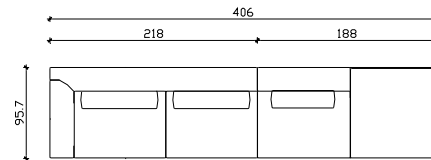

A181
B181

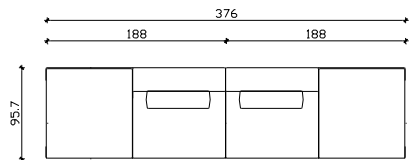

A182
B182

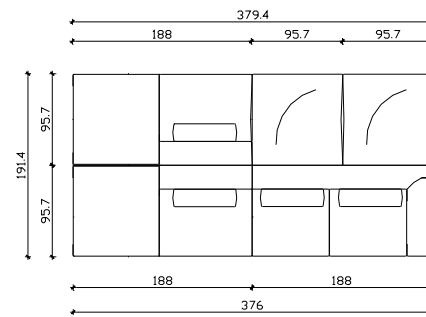

A184
B184

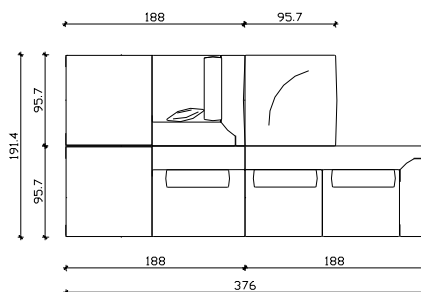

A185
B185

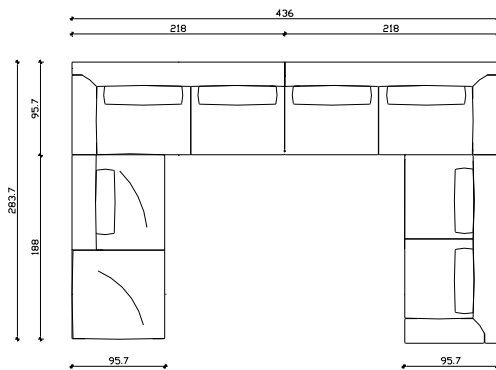

A186
B186

ADD_LOOK & BE_LOOK - Design Mauro Lipparini

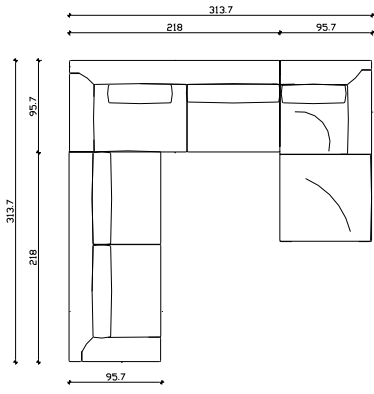

A187
B187

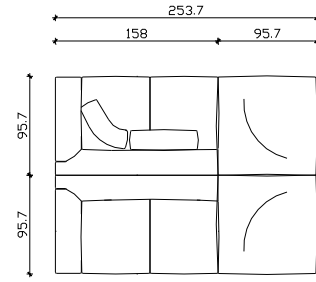

A188
B188

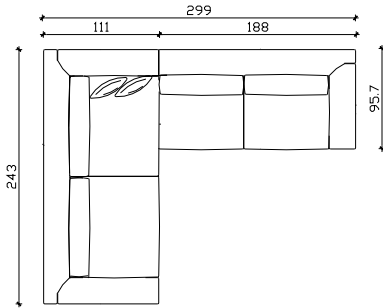

A189

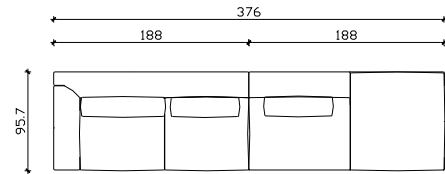

A190
B190

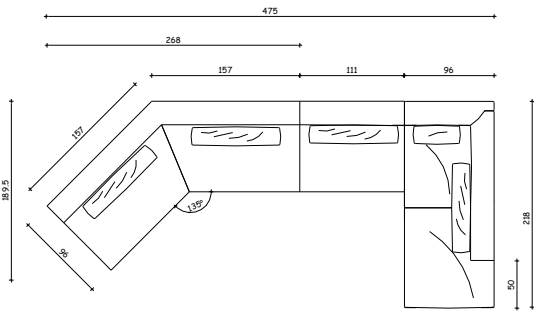

A191

ADD_LOOK ROUND - Design Mauro Lipparini

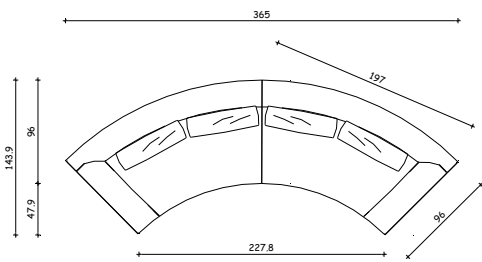

A200

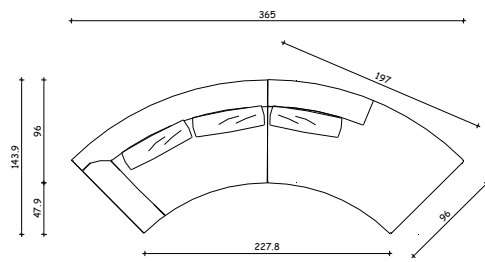

A201

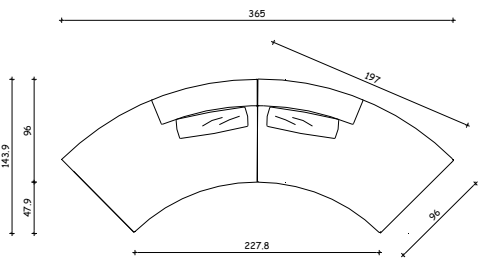

A202

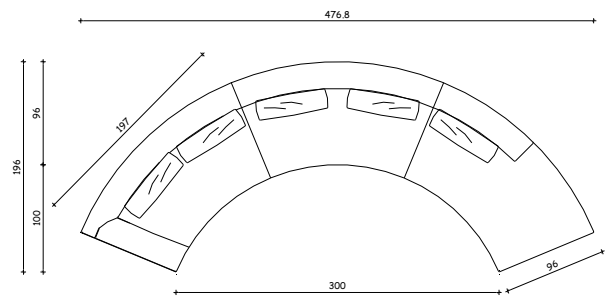

A203

ADD_LOOK ROUND - Design Mauro Lipparini

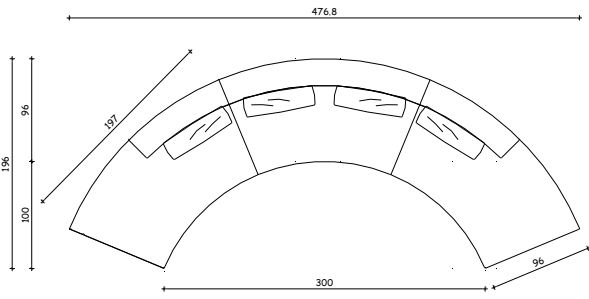

A204

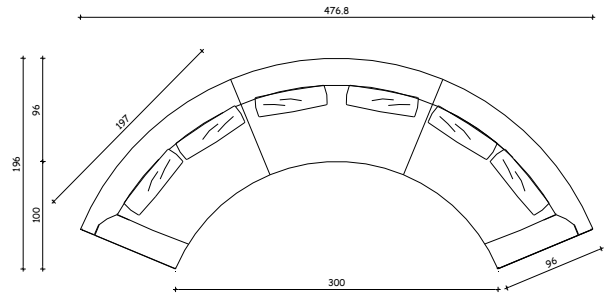

A205

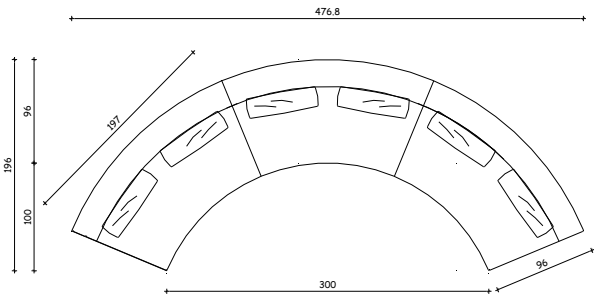

A206

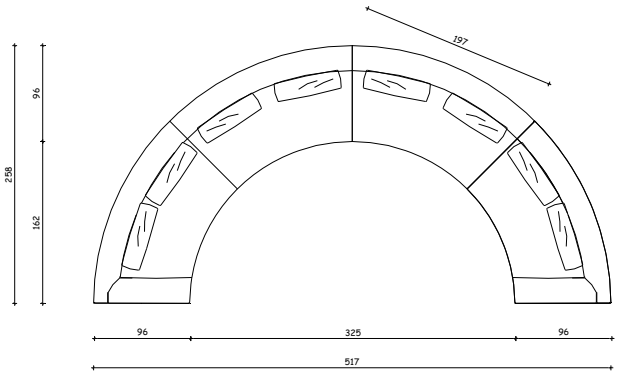

A207

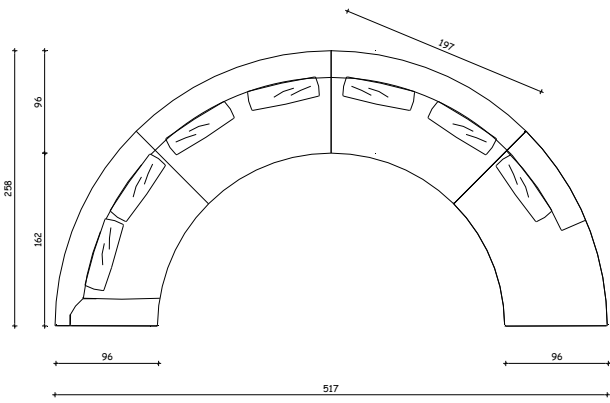

A208

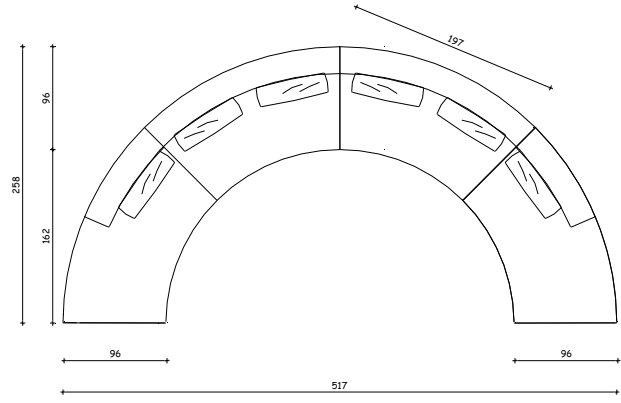

A209

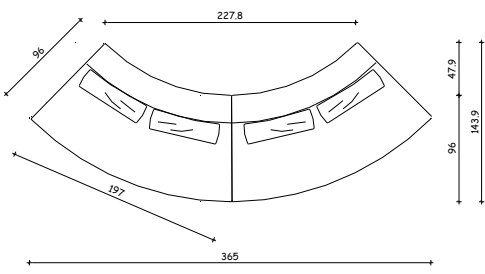

A210

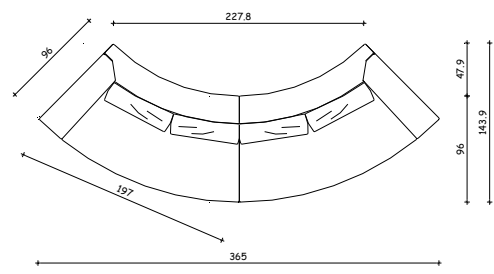

A211

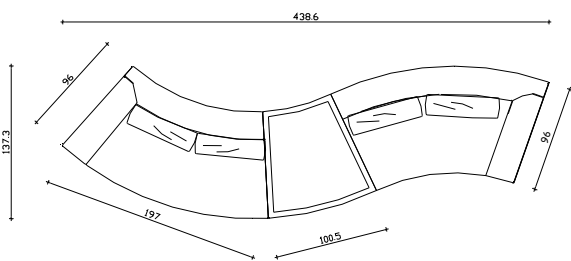

A212

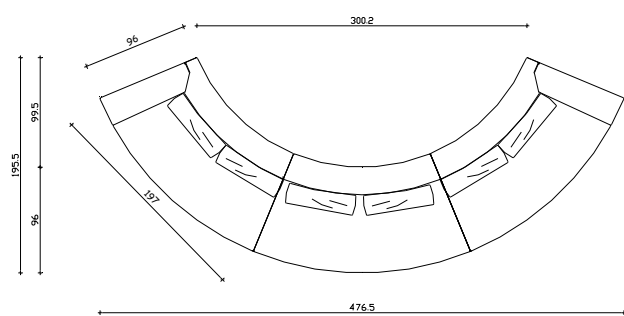

A213

ADD_LOOK ROUND - Design Mauro Lipparini

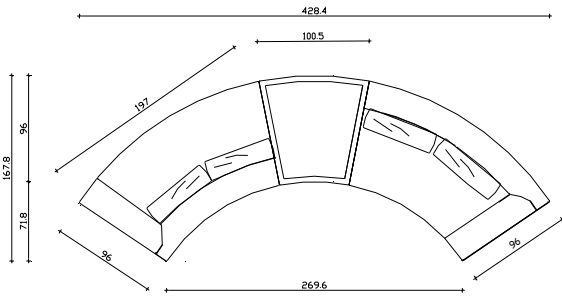

A214

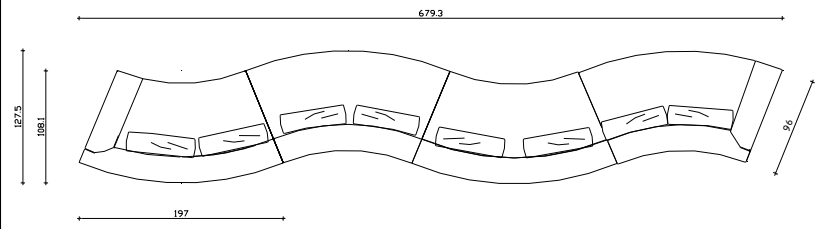

A215

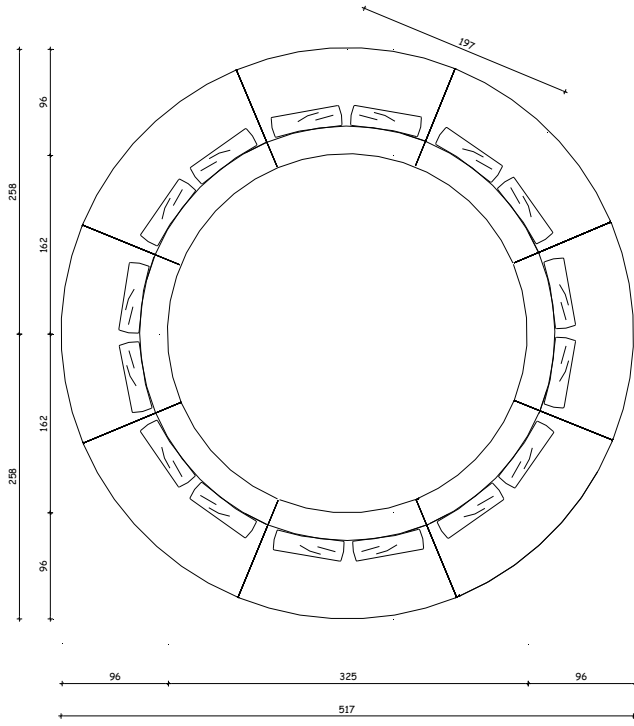

A216

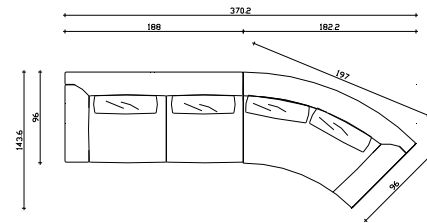

A217

ADD_LOOK - Design Mauro Lipparini

	COM	L	T	S	Z	K	PS	PF	PX	PA
A001	5.401,00	5.753,00	6.174,00	6.526,00	6.948,00	7.302,00	8.619,00	9.807,00	12.371,00	14.322,00
A002	5.798,00	6.177,00	6.634,00	7.016,00	7.476,00	7.860,00	9.298,00	10.585,00	13.466,00	15.603,00
A003	6.069,00	6.475,00	6.965,00	7.373,00	7.864,00	8.275,00	9.796,00	11.167,00	14.172,00	16.435,00
A004	5.598,00	5.968,00	6.410,00	6.781,00	7.223,00	7.596,00	8.953,00	10.194,00	12.870,00	14.908,00
A005	6.158,00	6.557,00	7.038,00	7.441,00	7.924,00	8.329,00	9.816,00	11.163,00	14.125,00	16.348,00
A006	6.393,00	6.814,00	7.321,00	7.743,00	8.251,00	8.677,00	10.208,00	11.572,00	14.720,00	17.087,00
A007	5.723,00	6.085,00	6.517,00	6.880,00	7.309,00	7.673,00	9.160,00	10.403,00	13.032,00	15.062,00
A008	6.120,00	6.509,00	6.977,00	7.370,00	7.837,00	8.231,00	9.839,00	11.181,00	14.127,00	16.343,00
A009	6.391,00	6.807,00	7.308,00	7.727,00	8.225,00	8.646,00	10.337,00	11.763,00	14.833,00	17.175,00
A010	5.920,00	6.300,00	6.753,00	7.135,00	7.584,00	7.967,00	9.494,00	10.790,00	13.531,00	15.648,00
A011	6.480,00	6.889,00	7.381,00	7.795,00	8.285,00	8.700,00	10.357,00	11.759,00	14.786,00	17.088,00
A012	6.715,00	7.146,00	7.664,00	8.097,00	8.612,00	9.048,00	10.749,00	12.168,00	15.381,00	17.827,00
A013	5.990,00	6.365,00	6.815,00	7.189,00	7.639,00	8.017,00	9.604,00	10.900,00	13.702,00	15.830,00
A014	6.387,00	6.789,00	7.275,00	7.679,00	8.167,00	8.575,00	10.283,00	11.678,00	14.797,00	17.111,00
A015	6.658,00	7.087,00	7.606,00	8.036,00	8.555,00	8.990,00	10.781,00	12.260,00	15.503,00	17.943,00
A016	6.187,00	6.580,00	7.051,00	7.444,00	7.914,00	8.311,00	9.938,00	11.287,00	14.201,00	16.416,00
A017	6.747,00	7.169,00	7.679,00	8.104,00	8.615,00	9.044,00	10.801,00	12.256,00	15.456,00	17.856,00
A018	6.982,00	7.426,00	7.962,00	8.406,00	8.942,00	9.392,00	11.193,00	12.665,00	16.051,00	18.595,00
A019	6.320,00	6.725,00	7.210,00	7.613,00	8.097,00	8.503,00	10.431,00	11.908,00	14.710,00	17.038,00
A020	6.717,00	7.149,00	7.670,00	8.103,00	8.625,00	9.061,00	11.110,00	12.686,00	15.805,00	18.319,00
A021	6.988,00	7.447,00	8.001,00	8.460,00	9.013,00	9.476,00	11.608,00	13.268,00	16.511,00	19.151,00
A022	6.517,00	6.940,00	7.446,00	7.868,00	8.372,00	8.797,00	10.765,00	12.295,00	15.209,00	17.624,00
A023	7.077,00	7.529,00	8.074,00	8.528,00	9.073,00	9.530,00	11.628,00	13.264,00	16.464,00	19.064,00
A024	7.312,00	7.786,00	8.357,00	8.830,00	9.400,00	9.878,00	12.020,00	13.673,00	17.059,00	19.803,00
A025	5.801,00	6.172,00	6.616,00	6.987,00	7.428,00	7.799,00	9.328,00	10.603,00	13.307,00	15.391,00
A026	6.198,00	6.596,00	7.076,00	7.477,00	7.956,00	8.357,00	10.007,00	11.381,00	14.402,00	16.672,00
A027	6.469,00	6.894,00	7.407,00	7.834,00	8.344,00	8.772,00	10.505,00	11.963,00	15.108,00	17.504,00
A028	5.998,00	6.387,00	6.852,00	7.242,00	7.703,00	8.093,00	9.662,00	10.990,00	13.806,00	15.977,00
A029	6.558,00	6.976,00	7.480,00	7.902,00	8.404,00	8.826,00	10.525,00	11.959,00	15.061,00	17.417,00
A030	6.793,00	7.233,00	7.763,00	8.204,00	8.731,00	9.174,00	10.917,00	12.368,00	15.656,00	18.156,00
A031	6.252,00	6.637,00	7.100,00	7.486,00	7.949,00	8.339,00	9.995,00	11.331,00	14.201,00	16.390,00
A032	6.649,00	7.061,00	7.560,00	7.976,00	8.477,00	8.897,00	10.674,00	12.109,00	15.296,00	17.671,00
A033	6.920,00	7.359,00	7.891,00	8.333,00	8.865,00	9.312,00	11.172,00	12.691,00	16.002,00	18.503,00
A034	6.449,00	6.852,00	7.336,00	7.741,00	8.224,00	8.633,00	10.329,00	11.718,00	14.700,00	16.976,00
A035	7.009,00	7.441,00	7.964,00	8.401,00	8.925,00	9.366,00	11.192,00	12.687,00	15.955,00	18.416,00
A036	7.244,00	7.698,00	8.247,00	8.703,00	9.252,00	9.714,00	11.584,00	13.096,00	16.550,00	19.155,00
A037	6.467,00	6.874,00	7.361,00	7.765,00	8.252,00	8.660,00	10.355,00	11.750,00	14.735,00	17.056,00
A038	6.864,00	7.298,00	7.821,00	8.255,00	8.780,00	9.218,00	11.034,00	12.528,00	15.830,00	18.337,00
A039	7.135,00	7.596,00	8.152,00	8.612,00	9.168,00	9.633,00	11.532,00	13.110,00	16.536,00	19.169,00
A040	6.664,00	7.089,00	7.597,00	8.020,00	8.527,00	8.954,00	10.689,00	12.137,00	15.234,00	17.642,00
A041	7.224,00	7.678,00	8.225,00	8.680,00	9.228,00	9.687,00	11.552,00	13.106,00	16.489,00	19.082,00
A042	7.459,00	7.935,00	8.508,00	8.982,00	9.555,00	10.035,00	11.944,00	13.515,00	17.084,00	19.821,00
A079	7.408,00	7.887,00	8.460,00	8.941,00	9.518,00	10.001,00	11.736,00	13.341,00	16.820,00	19.461,00
A080	7.798,00	8.303,00	8.910,00	9.416,00	10.029,00	10.540,00	12.389,00	14.085,00	17.824,00	20.626,00
A081	8.128,00	8.663,00	9.305,00	9.840,00	10.487,00	11.026,00	13.216,00	15.093,00	18.832,00	21.834,00
A088	5.391,00	5.722,00	6.119,00	6.453,00	6.849,00	7.184,00	8.470,00	9.600,00	12.028,00	13.883,00
A089	5.658,00	6.002,00	6.417,00	6.762,00	7.179,00	7.528,00	8.914,00	10.097,00	12.698,00	14.651,00
A090	5.988,00	6.362,00	6.812,00	7.186,00	7.637,00	8.014,00	9.741,00	11.105,00	13.706,00	15.859,00
A097	8.290,00	8.788,00	9.396,00	9.906,00	10.518,00	11.030,00	12.899,00	14.603,00	18.295,00	21.098,00
A098	8.680,00	9.204,00	9.846,00	10.381,00	11.029,00	11.569,00	13.552,00	15.347,00	19.299,00	22.263,00
A099	9.010,00	9.564,00	10.241,00	10.805,00	11.487,00	12.055,00	14.379,00	16.355,00	20.307,00	23.471,00
A179	4.964,00	5.278,00	5.653,00	5.968,00	6.345,00	6.661,00	7.865,00	8.928,00	11.211,00	12.956,00
A180	5.231,00	5.558,00	5.951,00	6.277,00	6.675,00	7.005,00	8.309,00	9.425,00	11.881,00	13.724,00
A181	5.561,00	5.918,00	6.346,00	6.701,00	7.133,00	7.491,00	9.136,00	10.433,00	12.889,00	14.932,00
A182	4.642,00	4.946,00	5.310,00	5.614,00	5.984,00	6.290,00	7.324,00	8.332,00	10.550,00	12.216,00
A184	10.464,00	11.113,00	11.892,00	12.538,00	13.325,00	13.978,00	16.403,00	18.617,00	23.484,00	27.142,00
A185	9.435,00	10.016,00	10.715,00	11.296,00	12.000,00	12.587,00	14.792,00	16.776,00	21.137,00	24.414,00
A186	11.711,00	12.448,00	13.333,00	14.065,00	14.957,00	15.697,00	19.257,00	21.959,00	27.109,00	31.372,00
A187	9.162,00	9.736,00	10.424,00	10.996,00	11.684,00	12.261,00	15.241,00	17.413,00	21.249,00	24.605,00
A188	7.858,00	8.310,00	8.852,00	9.304,00	9.848,00	10.302,00	12.178,00	13.760,00	17.210,00	19.818,00
A189	6.953,00	7.400,00	7.936,00	8.380,00	8.915,00	9.365,00	11.226,00	12.714,00	16.039,00	18.592,00
A190	5.252,00	5.583,00	5.980,00	6.309,00	6.711,00	7.044,00	8.341,00	9.464,00	11.936,00	13.792,00
A191	9.093,00	9.750,00	10.540,00	11.193,00	11.983,00	12.642,00	14.977,00	17.339,00	21.224,00	24.796,00

ADD_LOOK - Design Mauro Lipparini

	COM	L	T	S	Z	K	PS	PF	PX	PA
A200	6.764,00	7.138,00	7.594,00	7.968,00	8.428,00	8.808,00	10.574,00	11.896,00	15.768,00	18.082,00
A201	6.283,00	6.628,00	7.047,00	7.392,00	7.815,00	8.164,00	9.833,00	11.054,00	14.777,00	16.939,00
A202	5.802,00	6.118,00	6.500,00	6.816,00	7.202,00	7.520,00	9.092,00	10.212,00	13.786,00	15.796,00
A203	9.501,00	10.035,00	10.663,00	11.220,00	11.874,00	12.416,00	14.979,00	16.869,00	22.533,00	25.867,00
A204	9.020,00	9.525,00	10.116,00	10.644,00	11.261,00	11.772,00	14.238,00	16.027,00	21.542,00	24.724,00
A205	9.982,00	10.545,00	11.210,00	11.796,00	12.487,00	13.060,00	15.720,00	17.711,00	23.524,00	27.010,00
A206	9.654,00	10.221,00	10.848,00	11.484,00	12.177,00	12.756,00	15.438,00	17.445,00	23.268,00	26.784,00
A207	13.200,00	13.952,00	14.826,00	15.624,00	16.546,00	17.312,00	20.866,00	23.526,00	31.280,00	35.938,00
A208	12.719,00	13.442,00	14.279,00	15.048,00	15.933,00	16.668,00	20.125,00	22.684,00	30.289,00	34.795,00
A209	12.238,00	12.932,00	13.732,00	14.472,00	15.320,00	16.024,00	19.384,00	21.842,00	29.298,00	33.652,00
A210	5.926,00	6.290,00	6.728,00	7.088,00	7.532,00	7.898,00	9.744,00	11.056,00	13.902,00	16.060,00
A211	6.516,00	6.896,00	7.356,00	7.736,00	8.198,00	8.584,00	10.516,00	11.898,00	14.912,00	17.188,00
A212	7.590,00	7.998,00	8.494,00	8.902,00	9.400,00	9.815,00	11.809,00	13.276,00	16.969,00	19.455,00
A213	9.479,00	10.041,00	10.720,00	11.280,00	11.964,00	12.533,00	15.388,00	17.426,00	21.863,00	25.218,00
A214	7.590,00	7.998,00	8.494,00	8.902,00	9.400,00	9.815,00	11.809,00	13.276,00	16.969,00	19.455,00
A215	12.821,00	13.569,00	14.455,00	15.224,00	16.138,00	16.897,00	20.563,00	23.240,00	30.047,00	34.593,00
A216	23.704,00	25.160,00	26.912,00	28.352,00	30.128,00	31.592,00	38.976,00	44.224,00	55.608,00	64.240,00
A217	6.292,00	6.654,00	7.093,00	7.454,00	7.897,00	8.264,00	9.934,00	11.207,00	14.490,00	16.657,00

BE_LOOK - Design Mauro Lipparini

	COM	L	T	S	Z	K	PS	PF	PX	PA
B001	4.740,00	5.034,00	5.333,00	5.617,00	5.961,00	6.274,00	7.726,00	8.618,00	10.799,00	12.474,00
B002	5.095,00	5.412,00	5.730,00	6.037,00	6.407,00	6.745,00	8.288,00	9.254,00	11.652,00	13.464,00
B003	5.297,00	5.635,00	5.973,00	6.296,00	6.690,00	7.050,00	8.663,00	9.899,00	12.222,00	14.132,00
B007	5.096,00	5.399,00	5.690,00	5.980,00	6.331,00	6.660,00	8.071,00	9.120,00	11.318,00	13.023,00
B008	5.451,00	5.777,00	6.087,00	6.400,00	6.777,00	7.131,00	8.633,00	9.756,00	12.171,00	14.013,00
B009	5.653,00	6.000,00	6.330,00	6.659,00	7.060,00	7.436,00	9.008,00	10.401,00	12.741,00	14.681,00
B013	5.354,00	5.668,00	5.982,00	6.281,00	6.647,00	6.987,00	8.492,00	9.585,00	11.922,00	13.713,00
B014	5.709,00	6.046,00	6.379,00	6.701,00	7.093,00	7.458,00	9.054,00	10.221,00	12.775,00	14.703,00
B015	5.911,00	6.269,00	6.622,00	6.960,00	7.376,00	7.763,00	9.429,00	10.866,00	13.345,00	15.371,00
B019	5.600,00	5.933,00	6.263,00	6.576,00	6.966,00	7.323,00	8.853,00	10.209,00	12.452,00	14.328,00
B020	5.955,00	6.311,00	6.660,00	6.996,00	7.412,00	7.794,00	9.415,00	10.845,00	13.305,00	15.318,00
B021	6.157,00	6.534,00	6.903,00	7.255,00	7.695,00	8.099,00	9.790,00	11.490,00	13.875,00	15.986,00
B079	6.422,00	6.837,00	7.270,00	7.667,00	8.152,00	8.590,00	10.661,00	11.842,00	14.961,00	17.336,00
B080	6.794,00	7.233,00	7.689,00	8.111,00	8.624,00	9.090,00	11.279,00	12.541,00	15.883,00	18.406,00
B081	7.040,00	7.498,00	7.970,00	8.406,00	8.943,00	9.426,00	11.640,00	13.165,00	16.413,00	19.021,00
B088	4.659,00	4.944,00	5.232,00	5.508,00	5.840,00	6.146,00	7.408,00	8.400,00	10.532,00	12.158,00
B089	4.917,00	5.213,00	5.524,00	5.809,00	6.156,00	6.473,00	7.829,00	8.865,00	11.136,00	12.848,00
B090	5.163,00	5.478,00	5.805,00	6.104,00	6.475,00	6.809,00	8.190,00	9.489,00	11.666,00	13.463,00
B097	7.424,00	7.895,00	8.394,00	8.846,00	9.397,00	9.890,00	12.178,00	13.555,00	17.105,00	19.805,00
B098	7.796,00	8.291,00	8.813,00	9.290,00	9.869,00	10.390,00	12.796,00	14.254,00	18.027,00	20.875,00
B099	8.042,00	8.556,00	9.094,00	9.585,00	10.188,00	10.726,00	13.157,00	14.878,00	18.557,00	21.490,00
B179	4.324,00	4.595,00	4.881,00	5.137,00	5.454,00	5.740,00	7.091,00	7.906,00	9.935,00	11.487,00
B180	4.582,00	4.864,00	5.173,00	5.438,00	5.770,00	6.067,00	7.512,00	8.371,00	10.539,00	12.177,00
B181	4.828,00	5.129,00	5.454,00	5.733,00	6.089,00	6.403,00	7.873,00	8.995,00	11.069,00	12.792,00
B182	3.968,00	4.230,00	4.524,00	4.774,00	5.084,00	5.354,00	6.746,00	7.404,00	9.416,00	10.938,00
B184	8.570,00	9.095,00	9.683,00	10.183,00	10.802,00	11.344,00	13.919,00	15.499,00	19.535,00	22.584,00
B185	7.903,00	8.386,00	8.910,00	9.375,00	9.943,00	10.450,00	12.719,00	14.280,00	17.988,00	20.786,00
B186	10.270,00	10.892,00	11.557,00	12.130,00	12.864,00	13.519,00	16.512,00	18.957,00	23.261,00	26.823,00
B187	7.949,00	8.426,00	8.938,00	9.374,00	9.937,00	10.444,00	12.715,00	14.406,00	17.958,00	20.710,00
B188	6.368,00	6.720,00	7.120,00	7.458,00	7.872,00	8.232,00	9.848,00	11.082,00	13.796,00	15.838,00
B190	4.601,00	4.887,00	5.198,00	5.464,00	5.801,00	6.102,00	7.542,00	8.513,00	10.593,00	12.242,00

ALA - Design Matteo Nunziati



Struttura. In tubolare d'acciaio. Il molleggio è garantito da cinghie elastiche in polipropilene e lattice naturale fissate alla struttura di acciaio. La struttura è annegata in poliuretano espanso con densità di 60 kg/m³, schiumato a freddo tramite uno stampo e rivestita con vellutino accoppiato. La schiuma poliuretanicca soddisfa la classe 1 IM di resistenza al fuoco secondo la legge italiana ed è disponibile anche secondo altri standard internazionali.

Cuscini. Materassino di ovatta poliestere cucito assieme al rivestimento e fissato alla struttura tramite velcro.

Base. Base e bracciolo in multistrato di faggio curvato in stampo. Disponibili rivestiti in pelle o in assenza di noce canaletto fiammato con effetto cera.

Rivestimento. Disponibile in tessuto e pelle; non sfoderabile.

Frame. In tubular steel. The webbing is secured by elastic polypropylene and natural latex belts fixed to the metal frame. The frame is embedded in cold formed polyurethane made in mould with density of 60 kg/m³ and covered by bonded plush. The foam complies with the Italian Classe 1IM fire resistant law and is available on request for other international standards.

Cushions. Polyester wadding mat sewed with the final covering and fixed to the frame by Velcro.

Base. Base and arm are made in beech plywood panel curved into a mould. Available covered in leather or veneered in veined black walnut wood with wax effect finish.

Covers. Available in fabric or leather; non removable covers.



ALA000CHAISE1

I Chaiselongue imbottita con bracciolo destro o sinistro.

E Upholstered chaiselongue right or left arm.

F Chaiselongue rembourré avec accoudoir droit ou gauche.

D Gepolsterte Chaiselongue mit rechter oder linker Armlehne.

S Chaiselongue acolchada con brazo derecho o izquierdo.

cm. 156 x 70 x h 104 – hs 37/46 • mt. 5.85
in. 61¹/₂ x 27¹/₂ x h 41" – hs 14¹/₂"/18¹/₂" • yd. 6.40

COM	3.488,00
L	3.602,00
T	3.740,00
S	3.854,00
Z	3.992,00
K	4.107,00
PS	4.577,00
PF	4.992,00
PX	5.657,00
PA	6.280,00



ALA000CHAISE2

I Chaiselongue imbottita con bracciolo destro o sinistro. Basamento e bracciolo in noce canaletto.

E Upholstered chaiselongue right or left arm. Base and arm in black walnut wood.

F Chaiselongue rembourré avec accoudoir droit ou gauche. Base et accoudoir en noyer d'Amérique.

D Gepolsterte Chaiselongue mit rechter oder linker Armlehne. Gestell und Armlehne in Amerikanische Nussbaumholz.

S Chaiselongue acolchada con brazo derecho o izquierdo. Base y brazo en nogal americano.

cm. 156 x 70 x h 104 – hs 37/46 • mt. 4.75
in. 61¹/₂ x 27¹/₂ x h 41" – hs 14¹/₂"/18¹/₂" • yd. 5.20

COM	5.398,00
L	5.497,00
T	5.616,00
S	5.716,00
Z	5.835,00
K	5.934,00
PS	6.304,00
PF	6.674,00
PX	7.268,00
PA	7.825,00

BARLEY - Design Umberto Asnago



Struttura. Schienale in multistrato di pioppo curvato in stampo; sedile in legno massello di pioppo (stagionato "naturalmente" per almeno 3 anni); giunzioni a incastro con spine cilindriche. Il molleggio è garantito da cinghie elastiche in polipropilene e lattice naturale. L'imbottitura della struttura è ottenuta con lastre di poliuretano espanso indeformabile a densità differenziate (30÷35 kg/m³) esente da CFC ricoperto da vellutino accoppiato.

Base. In massello di noce canaletto con finitura a effetto cera. Braccioli in acciaio rivestiti in pelle.

Rivestimento. Disponibile in tessuto e pelle; non sfoderabile.

Frame. Back in poplar plywood panels curved in mould; seat in solid poplar heartwood ("naturally" seasoned for at least 3 years); dap joints with cylindrical dowels. The webbing is secured by elastic polypropylene and natural latex belts. The framework is upholstered with contoured sheets of resilient, CFC-free polyurethane foam (with density of 30÷35 kg/m³) covered by bonded plush.

Base. In solid black walnut heartwood with wax effect finishing. Arms in metal covered in leather.

Covers. Available in fabric or leather; non removable covers.



BARLEYPOLTRON

I Poltrona con struttura in noce canaletto. Braccioli in pelle.

E Armchair with black walnut frame. Arms covered in leather.

F Fauteuil avec structure en noyer d'Amérique. Accoudoirs en cuir souple.

D Sessel mit Gestell in Amerikanische Nussbaum. Armlehnen in Leder bezogen.

S Butaca con estructura en nogal americano. Brazos en piel.

cm. 64 x 90 x h 108 – hs 45 • mt. 2.20
in. 25¹/₄ x 35³/₄ x h 42¹/₂ – hs 17³/₄ • yd. 2.40

COM	2.487,00
L	2.531,00
T	2.582,00
S	2.625,00
Z	2.677,00
K	2.720,00
PS	2.868,00
PF	3.023,00
PX	3.272,00
PA	3.506,00

BEVERLY - Design Mauro Lipparini



Struttura. Nella versione in cuoio struttura in poliuretano compatto Baydur® CSP realizzato in stampo accoppiata a una lastra di poliuretano espanso indeformabile ed esente da CFC con densità 70 kg/m³. Nella versione in pelle o tessuto struttura in acciaio annegata in poliuretano espanso, schiumato a freddo tramite uno stampo. La schiuma poliuretanicca soddisfa la classe 1 IM di resistenza al fuoco secondo la legge italiana ed è disponibile anche secondo altri standard internazionali.

Base. Basamento fisso in acciaio; nella versione girevole base a 4 razze con pistone a gas. Disponibili in finitura cromata o verniciata a polveri epossidiche in colore RAL a scelta.

Rivestimento. Disponibile in cuoio, tessuto e pelle; non sfoderabile.

Frame. In the saddle leather version, frame in rigid polyurethane Baydur® CSP made in mould and coupled with a sheet of resilient, CFC-free polyurethane foam with density of 70 kg/m³. In the leather or fabric version, steel frame embedded in cold formed polyurethane foam made in mould. The foam complies with the Italian Classe 1IM fire resistant law and is available on request for other international standards.

Base. Fixed base in steel; in the swivel version, 4 star base with gas-piston. Available chromed or epoxy powder painted in RAL colors of your choice.

Covers. Available in saddle leather, fabric or leather; non removable covers.



BEVERLCUOIVER

- I Poltroncina rivestita in cuoio con basamento verniciato.
- E Small armchair covered in saddle leather with varnished feet.
- F Petit fauteuil recouvert en cuir epais avec pied verni.
- D Sessel in Rindleder mit Gestell lackiert.
- S Sillón tapizado en cuero con pata pintada.

CV 2.135,00
CF 1.970,00
CS 1.765,00

cm. 70 x 65 x h 70 – hs 30/40
in. 27”½ x 25”¾ x h 27”½ – hs 11”¾/15”¾



BEVERLSBCUOVE

- I Poltroncina senza braccioli rivestita in cuoio con basamento verniciato.
- E Small armchair without arms covered in saddle leather with varnished feet.
- F Petit fauteuil sans accouvoirs recouvert en cuir epais avec pied verni.
- D Sessel ohne Armlehnen in Rindleder mit Gestell lackiert.
- S Sillón sin brazos tapizado en cuero con pata pintada.

CV 2.053,00
CF 1.888,00
CS 1.683,00

cm. 63 x 65 x h 70 – hs 30/40
in. 24”¾ x 25”¾ x h 27”½ – hs 11”¾/15”¾



BEVERLCUOICRO

- I Poltroncina rivestita in cuoio con basamento cromato.
- E Small armchair covered in saddle leather with chromed feet.
- F Petit fauteuil recouvert en cuir epais avec pied chromé.
- D Sessel in Rindleder mit Gestell verchromt.
- S Sillón tapizado en cuero con pata cromada.

CV 2.360,00
CF 2.196,00
CS 1.990,00

cm. 70 x 65 x h 70 – hs 30/40
in. 27”½ x 25”¾ x h 27”½ – hs 11”¾/15”¾



BEVERLSBCUOCR

- I Poltroncina senza braccioli rivestita in cuoio con basamento cromato.
- E Small armchair without arms covered in saddle leather with chromed feet.
- F Petit fauteuil sans accouvoirs recouvert en cuir epais avec pied chromé.
- D Sessel ohne Armlehnen in Rindleder mit Gestell verchromt.
- S Sillón sin brazos tapizado en cuero con pata cromada.

CV 2.243,00
CF 2.079,00
CS 1.874,00

cm. 63 x 65 x h 70 – hs 30/40
in. 24”¾ x 25”¾ x h 27”½ – hs 11”¾/15”¾

BEVERLY - Design Mauro Lipparini



BEVERLIMBOVER

I Poltroncina imbottita con basamento verniciato.
 E Small upholstered armchair with varnished feet.
 F Petit fauteuil rembourré avec pied verni.
 D Gepolstert Sessel mit Gestell lackiert.
 S Sillón relleno con pata pintada.

cm. 70 x 65 x h 70 – hs 30/40 • mt. 1.20
 in. 27¹/₂ x 25³/₄ x h 27¹/₂ – hs 11³/₄/15³/₄ • yd. 1.30

COM	1.204,00
L	1.227,00
T	1.254,00
S	1.276,00
Z	1.304,00
K	1.327,00
PS	1.465,00
PF	1.609,00
PX	1.769,00
PA	1.919,00



BEVERLSBIMBVE

I Poltroncina senza braccioli imbottita con basamento verniciato.
 E Small upholstered armchair without arms and with varnished feet.
 F Petit fauteuil rembourré sans accoudoirs avec pied verni.
 D Gepolstert Sessel ohne Armlehnen mit Gestell lackiert.
 S Sillón relleno sin brazos con pata pintada.

cm. 63 x 65 x h 70 – hs 30/40 • mt. 1.20
 in. 24³/₄ x 25³/₄ x h 27¹/₂ – hs 11³/₄/15³/₄ • yd. 1.30

COM	1.118,00
L	1.140,00
T	1.168,00
S	1.191,00
Z	1.217,00
K	1.240,00
PS	1.379,00
PF	1.465,00
PX	1.656,00
PA	1.799,00



BEVERLIMBOCRO

I Poltroncina imbottita con basamento cromato.
 E Small upholstered armchair with chromed feet.
 F Petit fauteuil rembourré avec pied chromé.
 D Gepolstert Sessel mit Gestell verchromt.
 S Sillón relleno con pata cromada.

cm. 70 x 65 x h 70 – hs 30/40 • mt. 1.20
 in. 27¹/₂ x 25³/₄ x h 27¹/₂ – hs 11³/₄/15³/₄ • yd. 1.30

COM	1.440,00
L	1.463,00
T	1.490,00
S	1.513,00
Z	1.540,00
K	1.563,00
PS	1.701,00
PF	1.845,00
PX	2.004,00
PA	2.155,00



BEVERLSBIMBCR

I Poltroncina imbottita senza braccioli con basamento cromato.
 E Small upholstered armchair without arms and with chromed feet.
 F Petit fauteuil rembourré sans accoudoirs avec pied chromé.
 D Gepolstert Sessel ohne Armlehnen mit Gestell verchromt.
 S Sillón relleno sin brazos con pata cromada.

cm. 63 x 65 x h 70 – hs 30/40 • mt. 1.20
 in. 24³/₄ x 25³/₄ x h 27¹/₂ – hs 11³/₄/15³/₄ • yd. 1.30

COM	1.317,00
L	1.340,00
T	1.368,00
S	1.391,00
Z	1.417,00
K	1.440,00
PS	1.579,00
PF	1.664,00
PX	1.856,00
PA	1.999,00



BEVERLGIRCUVE

I Poltroncina girevole rivestita in cuoio con basamento verniciato.
 E Small swivel armchair covered in saddle leather with varnished feet.
 F Petit fauteuil tournant recouvert en cuir épais avec pied verni.
 D Drehsessel in Rindleder mit Gestell lackiert.
 S Sillón giratorio tapizado en cuero con pata pintada.

cm. 70 x 65 x h 70 – hs 30/40
 in. 27¹/₂ x 25³/₄ x h 27¹/₂ – hs 11³/₄/15³/₄

CV	2.484,00
CF	2.321,00
CS	2.115,00



BEVERLGISBCUV

I Poltroncina girevole senza braccioli rivestita in cuoio con basamento verniciato.
 E Small swivel armchair without arms covered in saddle leather with varnished feet.
 F Petit fauteuil tournant sans accoudoirs recouvert en cuir épais avec pied verni.
 D Drehsessel ohne Armlehnen in Rindleder mit Gestell lackiert.
 S Sillón giratorio sin brazos tapizado en cuero con pata pintada.

cm. 63 x 65 x h 70 – hs 30/40
 in. 24³/₄ x 25³/₄ x h 27¹/₂ – hs 11³/₄/15³/₄

CV	2.177,00
CF	2.013,00
CS	1.808,00

BEVERLY - Design Mauro Lipparini



BEVERLGIRCUCR

I Poltroncina girevole rivestita in cuoio con basamento cromato.
 E Small swivel armchair covered in saddle leather with chromed feet.
 F Petit fauteuil tournant recouvert en cuir epais avec pied chromé.
 D Drehsessel in Rindleder mit Gestell verchromt.
 S Sillón giratorio tapizado en cuero con pata cromada.

CV 2.665,00
 CF 2.500,00
 CS 2.294,00

cm. 70 x 65 x h 70 – hs 30/40
 in. 27¹/₂ x 25³/₄ x h 27¹/₂ – hs 11³/₄/15³/₄



BEVERLISBCUC

I Poltroncina girevole senza braccioli rivestita in cuoio con basamento cromato.
 E Small swivel armchair without arms covered in saddle leather with chromed feet.
 F Petit fauteuil tournant sans accoudoirs recouvert en cuir epais avec pied chromé.
 D Drehsessel ohne Armlehnen in Rindleder mit Gestell verchromt.
 S Sillón giratorio sin brazos tapizado en cuero con pata cromada.

CV 2.307,00
 CF 2.142,00
 CS 1.937,00

cm. 63 x 65 x h 70 – hs 30/40
 in. 24³/₄ x 25³/₄ x h 27¹/₂ – hs 11³/₄/15³/₄



BEVERLGIIMBVE

I Poltroncina girevole imbottita con basamento verniciato.
 E Small upholstered swivel armchair with varnished feet.
 F Petit fauteuil tournant rembourré avec pied verni.
 D Gepolstert Drehsessel mit Gestell lackiert.
 S Sillón giratorio relleno con pata pintada.

COM 1.518,00
 L 1.540,00
 T 1.566,00
 S 1.587,00
 Z 1.613,00
 K 1.635,00
 PS 1.766,00
 PF 1.849,00
 PX 2.030,00
 PA 2.167,00

cm. 70 x 65 x h 70 – hs 30/40 • mt. 1.20
 in. 27¹/₂ x 25³/₄ x h 27¹/₂ – hs 11³/₄/15³/₄ • yd. 1.30



BEVERLISBIMV

I Poltroncina girevole senza braccioli imbottita con basamento verniciato.
 E Small upholstered swivel armchair without arms and with varnished feet.
 F Petit fauteuil tournant rembourré sans accoudoirs avec pied verni.
 D Gepolstert Drehsessel ohne Armlehnen mit Gestell lackiert.
 S Sillón giratorio relleno sin brazos con pata pintada.

COM 1.345,00
 L 1.367,00
 T 1.393,00
 S 1.414,00
 Z 1.440,00
 K 1.462,00
 PS 1.635,00
 PF 1.730,00
 PX 1.883,00
 PA 2.025,00

cm. 63 x 65 x h 70 – hs 30/40 • mt. 1.20
 in. 24³/₄ x 25³/₄ x h 27¹/₂ – hs 11³/₄/15³/₄ • yd. 1.30



BEVERLGIIMBCR

I Poltroncina girevole imbottita con basamento cromato.
 E Small upholstered swivel armchair with chromed feet.
 F Petit fauteuil tournant rembourré avec pied chromé.
 D Gepolstert Drehsessel mit Gestell verchromt.
 S Sillón giratorio relleno con pata cromada.

COM 1.697,00
 L 1.719,00
 T 1.745,00
 S 1.766,00
 Z 1.792,00
 K 1.814,00
 PS 1.946,00
 PF 2.028,00
 PX 2.210,00
 PA 2.346,00

cm. 70 x 65 x h 70 – hs 30/40 • mt. 1.20
 in. 27¹/₂ x 25³/₄ x h 27¹/₂ – hs 11³/₄/15³/₄ • yd. 1.30



BEVERLISBIMC

I Poltroncina girevole imbottita senza braccioli con basamento cromato.
 E Small upholstered swivel armchair without arms and with chromed feet.
 F Petit fauteuil tournant rembourré sans accoudoirs avec pied chromé.
 D Gepolstert Drehsessel ohne Armlehnen mit Gestell verchromt.
 S Sillón relleno giratorio sin brazos con pata cromada.

COM 1.475,00
 L 1.497,00
 T 1.522,00
 S 1.544,00
 Z 1.570,00
 K 1.591,00
 PS 1.764,00
 PF 1.860,00
 PX 2.013,00
 PA 2.155,00

cm. 63 x 65 x h 70 – hs 30/40 • mt. 1.20
 in. 24³/₄ x 25³/₄ x h 27¹/₂ – hs 11³/₄/15³/₄ • yd. 1.30

BEVERLY - Design Mauro Lipparini



BEVERLPOUCUVE

I Pouf rivestito in cuoio con basamento verniciato.
 E Ottoman covered in saddle leather with varnished feet.
 F Pouf recouvert en cuir épais avec pied verni.
 D Hocker in Rindleder mit Gestell lackiert.
 S Pouf tapizado en cuero con pata pintada.

CV 1.083,00
 CF 1.030,00
 CS 965,00

cm. 64 x 45 x h 36 – hs 36
 in. 25”¼ x 17”¼ x h 14”¼ – hs 14”¼



BEVERLPOUCUCR

I Pouf rivestito in cuoio con basamento cromato.
 E Ottoman covered in saddle leather with chromed feet.
 F Pouf recouvert en cuir épais avec pied chromé.
 D Hocker in Rindleder mit Gestell verchromt.
 S Pouf tapizado en cuero con pata cromada.

CV 1.272,00
 CF 1.221,00
 CS 1.156,00

cm. 64 x 45 x h 36 – hs 36
 in. 25”¼ x 17”¼ x h 14”¼ – hs 14”¼



BEVERLPOUIMVE

I Pouf imbottito con basamento verniciato.
 E Upholstered ottoman with varnished feet.
 F Pouf rembourré avec pied verni.
 D Gepolstert Hocker mit Gestell lackiert.
 S Pouf relleno con pata pintada.

COM 859,00
 L 870,00
 T 883,00
 S 894,00
 Z 906,00
 K 918,00
 PS 994,00
 PF 1.035,00
 PX 1.126,00
 PA 1.194,00

cm. 64 x 45 x h 36 – hs 36 • mt. 0.60
 in. 25”¼ x 17”¼ x h 14”¼ – hs 14”¼ • yd. 0.65

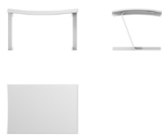

BEVERLPOUIMCR

I Pouf imbottito con basamento cromato.
 E Upholstered ottoman with chromed feet.
 F Pouf rembourré avec pied chromé.
 D Gepolstert Hocker mit Gestell verchromt.
 S Pouf relleno con pata cromada.

COM 1.050,00
 L 1.061,00
 T 1.073,00
 S 1.085,00
 Z 1.097,00
 K 1.108,00
 PS 1.185,00
 PF 1.226,00
 PX 1.316,00
 PA 1.384,00

cm. 64 x 45 x h 36 – hs 36 • mt. 0.60
 in. 25”¼ x 17”¼ x h 14”¼ – hs 14”¼ • yd. 0.65

BLOB - Design Umberto Asnago



Struttura. Schienale in tubolare d'acciaio fissato a un pannello di multistrato di pioppo curvato in stampo. Il sedile ha una struttura di tubolare d'acciaio; il molleggio è garantito da cinghie elastiche in polipropilene e lattice naturale fissate alla struttura in acciaio. Le due strutture separate di schienale e sedile sono annegate in poliuretano espanso, schiumato a freddo in due opportuni stampi e rivestite con fibre di poliestere. La schiuma poliuretana soddisfa la classe 1 IM di resistenza al fuoco secondo la legge italiana ed è disponibile anche secondo altri standard internazionali.

Base. Quattro piedini in PVC nero; disponibile a richiesta anche un basamento girevole in acciaio.

Rivestimento. Disponibile in tessuto e pelle; non sfoderabile.

Frame. The frame of the backrest is in tubular steel fixed to a panel of poplar plywood curved into a mould. The seat frame is in tubular steel; the webbing is secured by elastic polypropylene and natural latex belts fixed to the metal frame. The two frames are embedded in cold formed polyurethane foam made in two different moulds and covered by polyester wadding. The foam complies with the Italian Classe 1IM fire resistant law and is available on request for other international standards.

Base. Four feet in black PVC; available on request also a metal swivel base.

Covers. Available in fabric or leather; non removable covers.



BLOB00POLTRON

I Poltrona.

E Armchair.

F Fauteuil.

D Sessel.

S Butaca.

cm. 75 x 80 x h 71 – hs 38 • mt. 3.30
in. 29¹/₂ x 31¹/₂ x h 28" – hs 15" • yd. 3.60

COM	1.520,00
L	1.588,00
T	1.671,00
S	1.739,00
Z	1.820,00
K	1.852,00
PS	2.094,00
PF	2.330,00
PX	2.708,00
PA	3.062,00

BLOB00SUPGIRE

I Supplemento per poltrona girevole.

E Extra charge for swivel base on armchair.

F Supplément pour pied tournant de fauteuil.

D Mehrpreis fuer Drehbasis auf Sessel.

S Suplemento para sillón giratorio.

676,00

BRERA - Design Luca Scacchetti



Struttura. Lo schienale è in multistrato di pioppo. Il sedile è in legno massello di olmo (stagionato "naturalmente" per almeno 3 anni) con giunzioni a incastro con spine cilindriche; il molleggio è garantito da cinghie elastiche in polipropilene e lattice naturale. I braccioli sono in lamiera sciolata di acciaio. L'imbottitura dello schienale è ottenuta con ovatta poliestere.

Cuscini. Cuscini di seduta in poliuretano espanso indeformabile a densità differenziate (con densità 30÷35 kg/m³) ed esente da CFC rivestiti in ovatta poliestere e vellutino accoppiato. Cuscini di schienale in "Tecnolat", una miscela di fiocco al 100% poliestere cavo siliconato e schiuma di lattice tagliata in elementi romboidali di piccole dimensioni.

Base. Piedini in acciaio verniciato a polveri epossidiche in colore grigio chiaro opaco.

Rivestimento. Struttura rivestita in cuoio; cuscini sfoderabili disponibili in tessuto e pelle.

Tavolini. La struttura dei tavolini è in legno massello di pioppo (stagionato "naturalmente" per almeno 3 anni) con giunzioni a incastro con spine cilindriche e rivestita in cuoio; il piano in cristallo acidato poggia su un piano di particelle di legno melaminico.

Frame. The backrest is in poplar plywood. The seat is in solid elm heartwood ("naturally" seasoned for at least 3 years) with dap joints with cylindrical dowels; the webbing is secured by elastic polypropylene and natural latex belts. The arms are in steel. The backrest is upholstered with polyester wadding.

Cushions. The seat cushions are in resilient, CFC-free polyurethane foam (with density of 30÷35 kg/m³) covered by bonded plush and polyester wadding. The back cushions are in "Tecnolat", a mixture of 100% silicon-coated hollow staple polyester and natural latex foam cut into small lozenge-shaped pieces.

Base. Supports in steel epoxy powder painted in matt light grey color.

Covers. Frame covered in saddle leather; cushions available in fabric or leather with removable covers.

Low tables. The frame of the low tables is in solid poplar heartwood ("naturally" seasoned for at least 3 years) with dap joints with cylindrical dowels and covered in saddle leather; the top is in acid-etched glass laying on a panel of a melamine particleboard panel.



I Poltrona.
E Armchair.
F Fauteuil.
D Sessel.
S Butaca.

cm. 106 x 89 x h 89 – hs 40 • mt. 4.10
in. 41³/₄ x 35" x h 35" – hs 15³/₄ • yd. 4.50

	BRERA0CSPOLTR Cat. CS	BRERA0POLTRON Cat. CF	BRERA0CVPOLTR Cat. CV
COM	3.282,00	COM 3.872,00	COM 4.344,00
L	3.363,00	L 3.953,00	L 4.425,00
T	3.460,00	T 4.050,00	T 4.522,00
S	3.541,00	S 4.131,00	S 4.602,00
Z	3.638,00	Z 4.228,00	Z 4.656,00
K	3.719,00	K 4.309,00	K 4.739,00
PS	4.094,00	PS 4.690,00	PS 5.135,00
PF	4.390,00	PF 4.948,00	PF 5.439,00
PX	5.007,00	PX 5.620,00	PX 6.110,00
PA	5.511,00	PA 6.124,00	PA 6.615,00

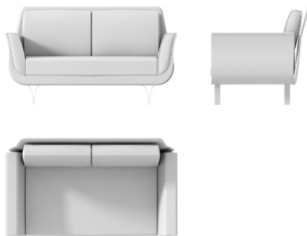

I Divano 2 posti.
E 2 seater sofa.
F Canapé 2 places.
D Sofa 2-sitzig.
S Sofá de 2 plazas.

cm. 156 x 89 x h 89 – hs 40 • mt. 5.50
in. 61¹/₂ x 35" x h 35" – hs 15³/₄ • yd. 6.00

	BRERA0CSDI2PO Cat. CS	BRERA0DIVA2PO Cat. CF	BRERA0CVDI2PO Cat. CV
COM	4.131,00	COM 4.841,00	COM 5.376,00
L	4.240,00	L 4.903,00	L 5.488,00
T	4.371,00	T 5.038,00	T 5.623,00
S	4.480,00	S 5.151,00	S 5.735,00
Z	4.611,00	Z 5.286,00	Z 5.870,00
K	4.721,00	K 5.398,00	K 5.983,00
PS	5.261,00	PS 6.000,00	PS 6.590,00
PF	5.693,00	PF 6.431,00	PF 7.022,00
PX	6.633,00	PX 7.372,00	PX 7.962,00
PA	7.346,00	PA 8.083,00	PA 8.675,00



I Divano 3 posti.
E 3 seater sofa.
F Canapé 3 places.
D Sofa 3-sitzig.
S Sofá de 3 plazas.

cm. 216 x 89 x h 89 – hs 40 • mt. 7.20
in. 85" x 35" x h 35" – hs 15³/₄ • yd. 7.90

	BRERA0CSDI3PO Cat. CS	BRERA0DIVA3PO Cat. CF	BRERA0CVDI3PO Cat. CV
COM	4.759,00	COM 5.646,00	COM 6.357,00
L	4.905,00	L 5.793,00	L 6.503,00
T	5.080,00	T 5.969,00	T 6.680,00
S	5.226,00	S 6.115,00	S 6.826,00
Z	5.401,00	Z 6.290,00	Z 7.001,00
K	5.548,00	K 6.436,00	K 7.147,00
PS	6.265,00	PS 7.163,00	PS 7.881,00
PF	6.810,00	PF 7.707,00	PF 8.425,00
PX	7.999,00	PX 8.896,00	PX 9.614,00
PA	8.898,00	PA 9.795,00	PA 10.513,00

BRERA - Design Luca Scacchetti



I Divano 4 posti.
E 4 seater sofa.
F Canapé 4 places.
D Sofa 4-sitzig.
S Sofá de 4 plazas.

cm. 276 x 89 x h 89 – hs 40 • mt. 9.40
in. 108³/₄ x 35³/₄ x h 35³/₄ – hs 15³/₄ • yd. 10.30

BRERA0CSDI4PO Cat. CS		BRERA0DIVA4PO Cat. CF		BRERA0CVDI4PO Cat. CV	
COM	5.456,00	COM	6.501,00	COM	7.339,00
L	5.647,00	L	6.693,00	L	7.530,00
T	5.876,00	T	6.923,00	T	7.759,00
S	6.068,00	S	7.114,00	S	7.951,00
Z	6.297,00	Z	7.343,00	Z	8.180,00
K	6.488,00	K	7.534,00	K	8.371,00
PS	7.395,00	PS	8.451,00	PS	9.296,00
PF	8.099,00	PF	9.156,00	PF	10.000,00
PX	9.634,00	PX	10.690,00	PX	11.535,00
PA	10.795,00	PA	11.852,00	PA	12.697,00



I Chaiselongue destra.
E Right chaiselongue.
F Chaise longue droite.
D Chaiselongue rechts.
S Chaise longue con rincón derecho.

cm. 89 x 160 x h 89 – hs 40 • mt. 4.80
in. 35³/₄ x 63³/₄ x h 35³/₄ – hs 15³/₄ • yd. 5.25

BRERA0CSCHADX Cat. CS		BRERA0CHAISDX Cat. CF		BRERA0CVCHADX Cat. CV	
COM	3.010,00	COM	3.480,00	COM	3.855,00
L	3.104,00	L	3.574,00	L	3.949,00
T	3.217,00	T	3.686,00	T	4.062,00
S	3.311,00	S	3.780,00	S	4.156,00
Z	3.423,00	Z	3.893,00	Z	4.269,00
K	3.517,00	K	3.987,00	K	4.363,00
PS	3.733,00	PS	4.207,00	PS	4.586,00
PF	4.015,00	PF	4.489,00	PF	4.828,00
PX	4.633,00	PX	5.074,00	PX	5.464,00
PA	5.066,00	PA	5.554,00	PA	5.944,00



I Chaiselongue sinistra.
E Left chaiselongue.
F Chaise longue gauche.
D Chaiselongue links.
S Chaise longue con rincón izquierdo.

cm. 89 x 160 x h 89 – hs 40 • mt. 4.80
in. 35³/₄ x 63³/₄ x h 35³/₄ – hs 15³/₄ • yd. 5.25

BRERA0CSCHASX Cat. CS		BRERA0CHAISX Cat. CF		BRERA0CVCHASX Cat. CV	
COM	2.916,00	COM	3.400,00	COM	3.786,00
L	3.013,00	L	3.497,00	L	3.883,00
T	3.129,00	T	3.612,00	T	3.999,00
S	3.226,00	S	3.709,00	S	4.096,00
Z	3.341,00	Z	3.825,00	Z	4.213,00
K	3.438,00	K	3.922,00	K	4.308,00
PS	3.659,00	PS	4.147,00	PS	4.537,00
PF	3.949,00	PF	4.437,00	PF	4.828,00
PX	4.586,00	PX	5.074,00	PX	5.464,00
PA	5.066,00	PA	5.554,00	PA	5.944,00



I Panca 2 posti con braccioli imbottiti.
E 2 seater bench with upholstered arms.
F Banc 2 places avec accoudoirs rembourrés.
D 2 Sitzigbank mit gepolsterten Armlehnen.
S Bancada de 2 plazas con brazos tapizados.

cm. 156 x 60 x h 63 – hs 40 • mt. 4.10
in. 61¹/₂ x 23³/₄ x h 24³/₄ – hs 15³/₄ • yd. 4.50

BRERA0CSPA2IM Cat. CS		BRERA0PANC2IM Cat. CF		BRERA0CVA2IM Cat. CV	
COM	2.617,00	COM	2.944,00	COM	3.204,00
L	2.701,00	L	3.027,00	L	3.288,00
T	2.801,00	T	3.127,00	T	3.388,00
S	2.884,00	S	3.211,00	S	3.471,00
Z	2.984,00	Z	3.310,00	Z	3.571,00
K	3.067,00	K	3.393,00	K	3.654,00
PS	3.666,00	PS	3.995,00	PS	4.259,00
PF	4.039,00	PF	4.368,00	PF	4.632,00
PX	4.845,00	PX	5.175,00	PX	5.438,00
PA	5.459,00	PA	5.788,00	PA	6.051,00



I Panca 3 posti con braccioli imbottiti.
E 3 seater bench with upholstered arms.
F Banc 3 places avec accoudoirs rembourrés.
D 3 Sitzigbank mit gepolsterten Armlehnen.
S Bancada de 3 plazas con brazos tapizados.

cm. 216 x 60 x h 63 – hs 40 • mt. 5.00
in. 85³/₄ x 23³/₄ x h 24³/₄ – hs 15³/₄ • yd. 5.45

BRERA0CSPA3IM Cat. CS		BRERA0PANC3IM Cat. CF		BRERA0CVA3IM Cat. CV	
COM	2.852,00	COM	3.213,00	COM	3.500,00
L	2.954,00	L	3.314,00	L	3.602,00
T	3.076,00	T	3.435,00	T	3.723,00
S	3.177,00	S	3.536,00	S	3.824,00
Z	3.298,00	Z	3.658,00	Z	3.946,00
K	3.399,00	K	3.758,00	K	4.047,00
PS	3.856,00	PS	4.219,00	PS	4.510,00
PF	4.228,00	PF	4.592,00	PF	4.882,00
PX	5.035,00	PX	5.398,00	PX	5.690,00
PA	5.649,00	PA	6.012,00	PA	6.303,00

BRERA - Design Luca Scacchetti

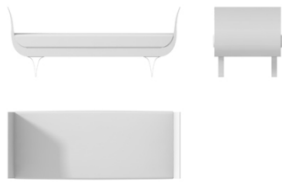

I Panca 2 posti.
E 2 seater bench.
F Banc 2 places.
D 2 Sitzigbank.
S Bancada de 2 plazas.

cm. 156 x 60 x h 63 – hs 40 • mt. 2.00
in. 61¹/₂ x 23³/₄ x h 24³/₄ – hs 15³/₄ • yd. 2.20

BRERA0CSPA2PO		BRERA0PANC2PO		BRERA0CSPA2PO	
Cat. CS		Cat. CF		Cat. CV	
COM	2.355,00	COM	2.681,00	COM	2.942,00
L	2.396,00	L	2.721,00	L	2.983,00
T	2.444,00	T	2.770,00	T	3.031,00
S	2.484,00	S	2.811,00	S	3.071,00
Z	2.533,00	Z	2.859,00	Z	3.120,00
K	2.573,00	K	2.899,00	K	3.161,00
PS	2.908,00	PS	3.106,00	PS	3.501,00
PF	3.098,00	PF	3.256,00	PF	3.692,00
PX	3.404,00	PX	3.589,00	PX	3.996,00
PA	3.689,00	PA	3.837,00	PA	4.283,00



I Panca 3 posti.
E 3 seater bench.
F Banc 3 places.
D 3 Sitzigbank.
S Bancada de 3 plazas.

cm. 216 x 60 x h 63 – hs 40 • mt. 2.70
in. 85¹/₂ x 23³/₄ x h 24³/₄ – hs 15³/₄ • yd. 2.95

BRERA0CSPA3PO		BRERA0PANC3PO		BRERA0CSPA3PO	
Cat. CS		Cat. CF		Cat. CV	
COM	2.439,00	COM	2.799,00	COM	3.087,00
L	2.493,00	L	2.853,00	L	3.140,00
T	2.557,00	T	2.918,00	T	3.205,00
S	2.612,00	S	2.972,00	S	3.260,00
Z	2.677,00	Z	3.036,00	Z	3.325,00
K	2.731,00	K	3.090,00	K	3.378,00
PS	3.001,00	PS	3.364,00	PS	3.655,00
PF	3.205,00	PF	3.569,00	PF	3.859,00
PX	3.651,00	PX	4.014,00	PX	4.305,00
PA	3.988,00	PA	4.352,00	PA	4.642,00



I Pouf.
E Ottoman.
F Pouf.
D Hocker.
S Pouf.

cm. 83 x 83 x h 40 – hs 40 • mt. 2.50
in. 32³/₄ x 32³/₄ x h 15³/₄ – hs 15³/₄ • yd. 2.75

BRERA0CSPOUF0		BRERA0POUF000		BRERA0CSPOUF0	
Cat. CS		Cat. CF		Cat. CV	
COM	961,00	COM	1.073,00	COM	1.163,00
L	988,00	L	1.100,00	L	1.191,00
T	1.020,00	T	1.133,00	T	1.223,00
S	1.048,00	S	1.160,00	S	1.249,00
Z	1.079,00	Z	1.192,00	Z	1.282,00
K	1.106,00	K	1.220,00	K	1.309,00
PS	1.226,00	PS	1.339,00	PS	1.431,00
PF	1.318,00	PF	1.433,00	PF	1.523,00
PX	1.532,00	PX	1.645,00	PX	1.736,00
PA	1.695,00	PA	1.816,00	PA	1.899,00



BRERA0TAVO090
I Tavolino.
E Coffee table.
F Table basse.
D Tisch.
S Mesa centro.

cm. 90 x 90 x h 23.5
in. 35¹/₂ x 35¹/₂ x h 9¹/₄

CV	1.475,00
CF	1.380,00
CS	1.263,00



BRERA0TAVO130
I Tavolino.
E Coffee table.
F Table basse.
D Tisch.
S Mesa centro.

cm. 130 x 130 x h 23.5
in. 51¹/₄ x 51¹/₄ x h 9¹/₄

CV	1.805,00
CF	1.673,00
CS	1.508,00



BRERA0TAVO160
I Tavolino.
E Coffee table.
F Table basse.
D Tisch.
S Mesa centro.

cm. 160 x 70 x h 23.5
in. 63¹/₂ x 27³/₄ x h 9¹/₄

CV	1.559,00
CF	1.427,00
CS	1.262,00

BRIDGE - Design Luca Scacchetti



Struttura. In legno massello di pioppo (stagionato "naturalmente" per almeno 3 anni) con elementi in multistrato di pioppo; giunzioni a incastro con spine cilindriche. Il molleggio è garantito da cinghie elastiche in polipropilene e lattice naturale. L'imbottitura della struttura è ottenuta con lastre di poliuretano espanso indeformabile a densità differenziate (40÷50 kg/m³) esente da CFC ricoperto da ovatta poliestere e vellutino accoppiato.

Cuscini. Cuscino di seduta in poliuretano espanso indeformabile con densità 30 kg/m³ ed esente da CFC ricoperto da ovatta poliestere e vellutino accoppiato. Cuscini di schienale in "Tecnolat", una miscela di fiocco al 100% poliestere cavo siliconato e schiuma di lattice tagliata in elementi romboidali di piccole dimensioni. Cuscini dei braccioli in piuma.

Base. Piedini in acciaio verniciato a polveri epossidiche in colore grigio chiaro opaco.

Rivestimento. Disponibile in tessuto e pelle; sfoderabile solo nella versione in tessuto.

Frame. In solid poplar heartwood ("naturally" seasoned for at least 3 years) with connecting elements in poplar plywood; dap joints with cylindrical dowels. The webbing is secured by elastic polypropylene and natural latex belts. The framework is upholstered with contoured sheets of resilient, CFC-free polyurethane foam (with density of 40÷50 kg/m³) covered by polyester wadding and bonded plush.

Cushions. The seat cushion is in resilient, CFC-free polyurethane foam with density of 30 kg/m³ covered by bonded plush and polyester wadding. The back cushions are in "Tecnolat", a mixture of 100% silicon-coated hollow staple polyester and natural latex foam cut into small lozenge-shaped pieces. The arm loose cushions are feather filled.

Base. Supports in steel epoxy powder painted in matt light grey color.

Covers. Available in fabric or leather; removable covers only for fabric version.

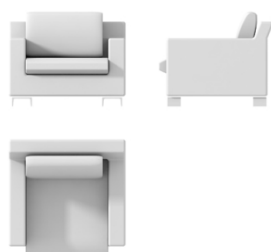

BRIDGEPOLTRON

- I Poltrona
- E Armchair
- F Fauteuil
- D Sessel
- S Butaca.

cm. 106 x 105 x h 84 – hs 40 • mt. 7.70
in. 41³/₄ x 41³/₄ x h 33³/₄ – hs 15³/₄ • yd. 8.40

COM	2.096,00
L	2.258,00
T	2.452,00
S	2.615,00
Z	2.810,00
K	2.972,00
PS	3.525,00
PF	4.056,00
PX	5.221,00
PA	6.101,00

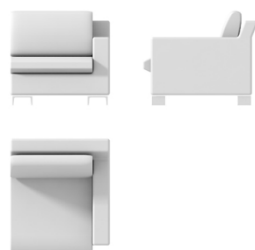

BRIDGEPOLTRDX

- I Poltrona con bracciolo destro.
- E Armchair with right arm.
- F Fauteuil avec accoudoir droit.
- D Sessel mit rechter Armlehne.
- S Butaca con brazo derecho.

cm. 91 x 105 x h 84 – hs 40 • mt. 6.60
in. 35³/₄ x 41³/₄ x h 33³/₄ – hs 15³/₄ • yd. 7.20

COM	1.898,00
L	2.028,00
T	2.184,00
S	2.313,00
Z	2.469,00
K	2.599,00
PS	3.175,00
PF	3.634,00
PX	4.632,00
PA	5.388,00





BRIDGEPOLTRSX

- I Poltrona con bracciolo sinistro.
- E Armchair with left arm.
- F Fauteuil avec accoudoir gauche.
- D Sessel mit linker Armlehne.
- S Butaca con brazo izquierdo.

cm. 91 x 105 x h 84 – hs 40 • mt. 6.60
in. 35³/₄ x 41³/₄ x h 33³/₄ – hs 15³/₄ • yd. 7.20

COM	1.898,00
L	2.028,00
T	2.184,00
S	2.313,00
Z	2.469,00
K	2.599,00
PS	3.175,00
PF	3.634,00
PX	4.632,00
PA	5.388,00

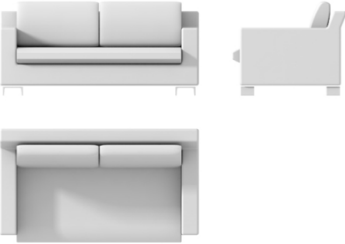
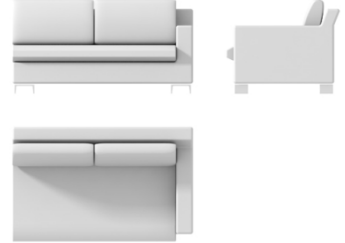
BRIDGE - Design Luca Scacchetti

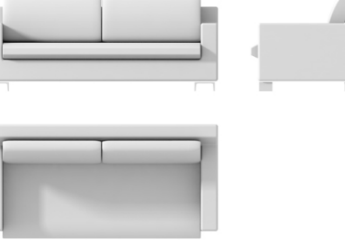
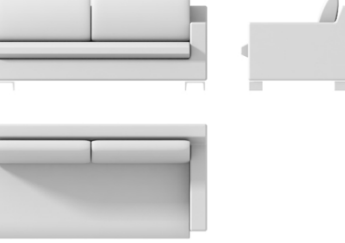
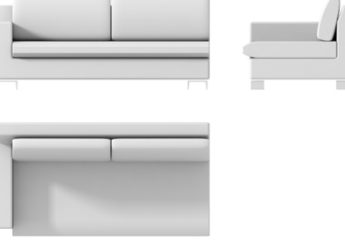
	<p>BRIDGEDIVA2PI</p> <p>I Divano 2 posti cm. 180. E 2 seater sofa cm. 180. F Canapé 2 places cm. 180. D Sofa 2-sitzig cm. 180. S Sofá de 2 plazas cm. 180.</p>	<p>COM 2.754,00 L 2.988,00 T 3.268,00 S 3.502,00 Z 3.782,00 K 4.016,00 PS 5.085,00 PF 5.620,00 PX 7.324,00 PA 8.615,00</p>
	<p>BRIDGEDIV2PDX</p> <p>I Divano 2 posti con bracciolo destro. E 2 seater sofa with right arm. F Canapé 2 places avec accoudoir droit. D Sofa 2-sitzig mit rechter Armlehne. S Sofá de 2 plazas con brazo derecho.</p>	<p>COM 2.561,00 L 2.757,00 T 2.993,00 S 3.190,00 Z 3.426,00 K 3.624,00 PS 4.553,00 PF 5.284,00 PX 6.880,00 PA 8.087,00</p>
	<p>BRIDGEDIV2PSX</p> <p>I Divano 2 posti con bracciolo sinistro. E 2 seater sofa with left arm. F Canapé 2 places avec accoudoir gauche. D Sofa 2-sitzig mit linker Armlehne. S Sofá de 2 plazas con brazo izquierdo.</p>	<p>COM 2.561,00 L 2.757,00 T 2.993,00 S 3.190,00 Z 3.426,00 K 3.624,00 PS 4.553,00 PF 5.284,00 PX 6.880,00 PA 8.087,00</p>
	<p>BRIDGEDIVA2GR</p> <p>I Divano 2 posti cm. 210. E 2 seater sofa cm. 210. F Canapé 2 places cm. 210. D Sofa 2-sitzig cm. 210. S Sofá de 2 plazas cm. 210.</p>	<p>COM 3.045,00 L 3.304,00 T 3.616,00 S 3.876,00 Z 4.187,00 K 4.447,00 PS 5.225,00 PF 6.061,00 PX 7.873,00 PA 9.248,00</p>
	<p>BRIDGEDIV2GDX</p> <p>I Divano 2 posti con bracciolo destro. E 2 seater sofa with right arm. F Canapé 2 places avec accoudoir droit. D Sofa 2-sitzig mit rechter Armlehne. S Sofá de 2 plazas con brazo derecho.</p>	<p>COM 2.849,00 L 3.085,00 T 3.368,00 S 3.603,00 Z 3.886,00 K 4.122,00 PS 4.906,00 PF 5.690,00 PX 7.393,00 PA 8.685,00</p>
	<p>BRIDGEDIV2GSX</p> <p>I Divano 2 posti con bracciolo sinistro. E 2 seater sofa with left arm. F Canapé 2 places avec accoudoir gauche. D Sofa 2-sitzig mit linker Armlehne. S Sofá de 2 plazas con brazo izquierdo.</p>	<p>COM 2.849,00 L 3.085,00 T 3.368,00 S 3.603,00 Z 3.886,00 K 4.122,00 PS 4.906,00 PF 5.690,00 PX 7.393,00 PA 8.685,00</p>

BRIDGE - Design Luca Scacchetti

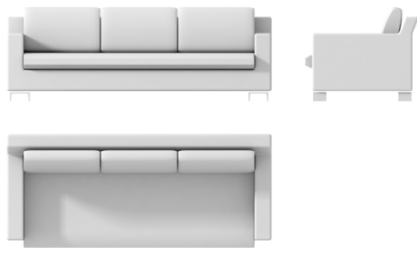

BRIDGEDIVA3PO

I Divano 3 posti.
E 3 seater sofa.
F Canapé 3 places.
D Sofa 3-sitzig.
S Sofá de 3 plazas.

cm. 240 x 105 x h 84 – hs 40 • mt. 14.80
in. 94¹/₂ x 41³/₈ x h 33³/₈ – hs 15³/₈ • yd. 16.20

COM	3.413,00
L	3.703,00
T	4.051,00
S	4.340,00
Z	4.689,00
K	4.978,00
PS	5.704,00
PF	6.591,00
PX	8.524,00
PA	9.988,00



BRIDGEDIV3PDX

I Divano 3 posti con bracciolo destro.
E 3 seater sofa with right arm.
F Canapé 3 places avec accoudoir droit.
D Sofa 3-sitzig mit rechter Armlehne.
S Sofá de 3 plazas con brazo derecho.

cm. 225 x 105 x h 84 – hs 40 • mt. 13.70
in. 88¹/₂ x 41³/₈ x h 33³/₈ – hs 15³/₈ • yd. 15.00

COM	3.209,00
L	3.477,00
T	3.799,00
S	4.067,00
Z	4.389,00
K	4.658,00
PS	5.371,00
PF	6.207,00
PX	8.019,00
PA	9.395,00



BRIDGEDIV3PSX

I Divano 3 posti con bracciolo sinistro.
E 3 seater sofa with left arm.
F Canapé 3 places avec accoudoir gauche.
D Sofa 3-sitzig mit linker Armlehne.
S Sofá de 3 plazas con brazo izquierdo.

cm. 225 x 105 x h 84 – hs 40 • mt. 13.70
in. 88¹/₂ x 41³/₈ x h 33³/₈ – hs 15³/₈ • yd. 15.00

COM	3.209,00
L	3.477,00
T	3.799,00
S	4.067,00
Z	4.389,00
K	4.658,00
PS	5.371,00
PF	6.207,00
PX	8.019,00
PA	9.395,00

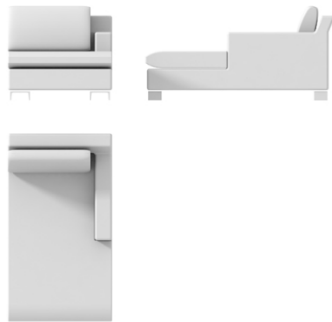

BRIDGECHAISDX

I Chaiselongue destra.
E Right chaiselongue.
F Chaise longue droite.
D Chaiselongue rechts.
S Chaise longue con rincón derecho.

cm. 94 x 170 x h 84 – hs 40 • mt. 9.10
in. 37" x 66³/₈ x h 33³/₈ – hs 15³/₈ • yd. 9.95

COM	2.336,00
L	2.513,00
T	2.726,00
S	2.904,00
Z	3.117,00
K	3.294,00
PS	3.702,00
PF	4.243,00
PX	5.421,00
PA	6.314,00

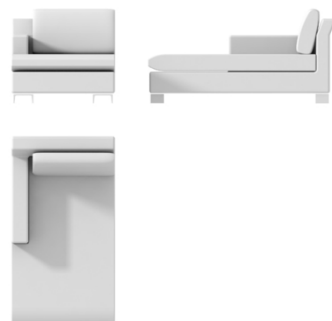

BRIDGECHAISX

I Chaiselongue sinistra.
E Left chaiselongue.
F Chaise longue gauche.
D Chaiselongue links.
S Chaise longue con rincón izquierdo.

cm. 94 x 170 x h 84 – hs 40 • mt. 9.10
in. 37" x 66³/₈ x h 33³/₈ – hs 15³/₈ • yd. 9.95

COM	2.336,00
L	2.513,00
T	2.726,00
S	2.904,00
Z	3.117,00
K	3.294,00
PS	3.702,00
PF	4.243,00
PX	5.421,00
PA	6.314,00

BRIDGE - Design Luca Scacchetti

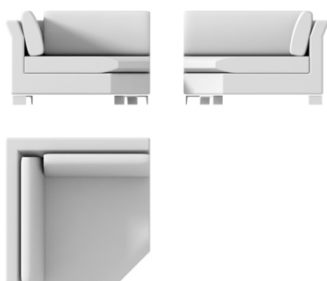

BRIDGEANGOLOO
 I Angolo cm. 133x133.
 E Corner unit cm. 133x133.
 F Angle cm. 133x133.
 D Eckteil cm. 133x133.
 S Rincón cm. 133x133.

cm. 133 x 133 x h 84 – hs 40 • mt. 11.00
 in. 52” $\frac{3}{8}$ x 52” $\frac{3}{8}$ x h 33” $\frac{3}{8}$ – hs 15” $\frac{3}{8}$ • yd. 12.05

COM	2.771,00
L	2.987,00
T	3.247,00
S	3.463,00
Z	3.722,00
K	3.939,00
PS	4.565,00
PF	5.244,00
PX	6.732,00
PA	7.855,00



BRIDGEANGOPIC
 I Angolo
 E Corner unit.
 F Angle.
 D Eckteil.
 S Rincón.

cm. 105 x 105 x h 84 – hs 40 • mt. 7.70
 in. 41” $\frac{3}{8}$ x 41” $\frac{3}{8}$ x h 33” $\frac{3}{8}$ – hs 15” $\frac{3}{8}$ • yd. 8.40

COM	2.173,00
L	2.325,00
T	2.507,00
S	2.658,00
Z	2.840,00
K	2.991,00
PS	3.631,00
PF	4.162,00
PX	5.315,00
PA	6.191,00



BRIDGEPOUF000
 I Pouf.
 E Ottoman.
 F Pouf.
 D Hocker.
 S Pouf.

cm. 95 x 95 x h 43 – hs 43 • mt. 2.20
 in. 37” $\frac{3}{8}$ x 37” $\frac{3}{8}$ x h 16” $\frac{3}{8}$ – hs 16” $\frac{3}{8}$ • yd. 2.40

COM	740,00
L	788,00
T	845,00
S	892,00
Z	950,00
K	997,00
PS	1.178,00
PF	1.351,00
PX	1.728,00
PA	2.014,00

CASSANDRA - Design Luca Scacchetti



Struttura. In tubolare d'acciaio. Il molleggio è garantito da cinghie elastiche in polipropilene e lattice naturale fissate alla struttura in acciaio. La struttura è annegata in poliuretano espanso con densità di 60 kg/m³, schiumato a freddo tramite uno stampo. La schiuma poliuretanicca soddisfa la classe 1 IM di resistenza al fuoco secondo la legge italiana ed è disponibile anche secondo altri standard internazionali. Lo schienale è ricoperto di ovatta poliestere.

Cuscini. Cuscino di seduta in poliuretano espanso indeformabile esente da CFC ricoperto da ovatta poliestere.

Base. Basamento fisso con 4 gambe in acciaio verniciato a polveri epossidiche in colore RAL a scelta; nella versione girevole base a 4 razze con pistone a gas, disponibile in finitura cromata o verniciata a polveri epossidiche in colore RAL a scelta.

Rivestimento. Disponibile in tessuto e pelle; non sfoderabile.

Frame. In tubular steel. The webbing is secured by elastic polypropylene and natural latex belts fixed to the metal frame. The frame is embedded in cold formed polyurethane made in mould with density of 60 kg/m³. The foam complies with the Italian Classe 1IM fire resistant law and is available on request for other international standards. The backrest is covered by polyester wadding.

Cushions. Seat cushion in resilient polyurethane foam CFC-free covered by polyester wadding.

Base. Fixed base with 4 feet in steel epoxy powder painted in RAL colors of your choice; in the swivel version, 4 star base with gas-piston, available chromed or epoxy powder painted in RAL colors of your choice.

Covers. Available in fabric or leather; non removable covers.



CASSANPOLTGIR

- I Poltrona relax girevole con base cromata.
- E Relax armchair with swivel chromed base
- F Fauteuil relax tournant avec piétement chromé.
- D Drehsessel relax mit verchromtem Fuss.
- S Sillón relax giratorio con base cromada.

cm. 76 x 77 x h 120.5 – hs 48 • mt. 4.95
in. 29⁷/₈ x 30³/₈ x h 47¹/₂ – hs 18⁷/₈ • yd. 5.40

COM	2.480,00
L	2.587,00
T	2.716,00
S	2.822,00
Z	2.951,00
K	3.058,00
PS	3.408,00
PF	3.765,00
PX	4.336,00
PA	4.872,00



CASSANPOLTRON

- I Poltrona relax con base verniciata.
- E Relax armchair with varnished base
- F Fauteuil relax tournant avec piétement verni.
- D Drehsessel relax mit lackiertem Fuss.
- S Sillón relax giratorio con base barnizada.

cm. 76 x 77 x h 120.5 – hs 48 • mt. 4.95
in. 29⁷/₈ x 30³/₈ x h 47¹/₂ – hs 18⁷/₈ • yd. 5.40

COM	2.237,00
L	2.344,00
T	2.473,00
S	2.580,00
Z	2.709,00
K	2.816,00
PS	3.165,00
PF	3.523,00
PX	4.093,00
PA	4.629,00

CHIMERA - Design Matteo Nunziati



Struttura. Il sedile è in legno massello di pioppo e faggio (stagionato "naturalmente" per almeno 3 anni) con elementi in multistrato di pioppo; giunzioni a incastro con spine cilindriche. Il molleggio è garantito da cinghie elastiche in polipropilene e lattice naturale. L'imbottitura del sedile è ottenuta con lastre di poliuretano espanso indeformabile a densità differenziate (18÷35 kg/m³) esente da CFC; il sedile è poi rivestito con una trapunta realizzata con ovatta poliestere e tessuto o pelle. Lo schienale e i braccioli sono in pannello nobilitato imbottito con lastre di poliuretano espanso indeformabile a densità 30 kg/m³ esente da CFC; questi sono poi rivestiti con una trapunta realizzata con ovatta poliestere e tessuto o pelle.

Cuscini. Cuscino di schienale in poliuretano espanso indeformabile ed esente da CFC rivestito con una trapunta realizzata con ovatta poliestere e tessuto o pelle.

Base. Piedini in tubolare d'acciaio. Disponibili in finitura cromata o verniciata a polveri epossidiche in colore RAL a scelta.

Rivestimento. Disponibile in tessuto e pelle; non sfoderabile.

Piani. I piani di mensole laterali e posteriori e il tavolino sono realizzati con pannelli di particelle di legno impiallacciati in essenza di noce canaletto fiammato con finitura effetto cera.

Frame. The seat frame is in solid poplar and beech heartwood ("naturally" seasoned for at least 3 years) with connecting elements in poplar plywood; dap joints with cylindrical dowels. The webbing is secured by elastic polypropylene and natural latex belts. The framework is upholstered with contoured sheets of resilient, CFC-free polyurethane foam (with density of 18÷35 kg/m³); the seat is at the end covered with a polyester wadding quilted mat of fabric or leather. The backrest and the armrest are made in melamine coated panel upholstered with contoured sheets of resilient, CFC-free polyurethane foam with density of 30 kg/m³; these are at the end covered with a polyester wadding quilted mat of fabric or leather.

Cushions. The back cushion is in resilient, CFC-free polyurethane foam covered with a polyester wadding quilted mat of fabric or leather.

Base. Supports in tubular steel. Available chromed or epoxy powder painted in RAL colors of your choice.

Covers. Available in fabric or leather; non removable covers.

Top. Top of rear and side shelves and the low table are made with particleboard panels veneered in veined black walnut wood with wax effect finishing.



CHIMERBASE180

I Elemento di seduta cm. 180x101.
E Seating element cm. 180x101.
F Élément d'assise cm. 180x101.
D Sitting Element cm. 180x101.
S Elemento de asiento cm. 180x101.

cm. 180 x 101 x h 38.5 – hs 38.5 • mt. 3.20
in. 70"½ x 39"¾ x h 15"½ – hs 15"½ • yd. 3.50

COM	1.505,00
L	1.568,00
T	1.643,00
S	1.706,00
Z	1.781,00
K	1.844,00
PS	2.130,00
PF	2.360,00
PX	2.726,00
PA	3.070,00



CHIMERBASE210

I Elemento di seduta cm. 210x101.
E Seating element cm. 210x101.
F Élément d'assise cm. 210x101.
D Sitting Element cm. 210x101.
S Elemento de asiento cm. 210x101.

cm. 210 x 101 x h 38.5 – hs 38.5 • mt. 3.65
in. 82"½ x 39"¾ x h 15"½ – hs 15"½ • yd. 4.00

COM	1.647,00
L	1.719,00
T	1.805,00
S	1.876,00
Z	1.961,00
K	2.033,00
PS	1.973,00
PF	2.607,00
PX	3.022,00
PA	3.411,00



CHIMERBASE240

I Elemento di seduta cm. 240x101.
E Seating element cm. 240x101.
F Élément d'assise cm. 240x101.
D Sitting Element cm. 240x101.
S Elemento de asiento cm. 240x101.

cm. 240 x 101 x h 38.5 – hs 38.5 • mt. 4.20
in. 94"½ x 39"¾ x h 15"½ – hs 15"½ • yd. 4.60

COM	1.821,00
L	1.903,00
T	2.001,00
S	2.084,00
Z	2.183,00
K	2.265,00
PS	2.627,00
PF	2.924,00
PX	3.402,00
PA	3.850,00

CHIMERA - Design Matteo Nunziati



CHIMERBASE270

I Elemento di seduta cm. 270x101.
 E Seating element cm. 270x101.
 F Élément d'assise cm. 270x101.
 D Sitting Element cm. 270x101.
 S Elemento de asiento cm. 270x101.

cm. 270 x 101 x h 38.5 – hs 38.5 • mt. 4.65
 in. 106³/₄ x 39³/₄ x h 15³/₄ – hs 14" • yd. 5.10

COM	1.939,00
L	2.031,00
T	2.139,00
S	2.231,00
Z	2.340,00
K	2.431,00
PS	2.815,00
PF	3.144,00
PX	3.669,00
PA	4.162,00

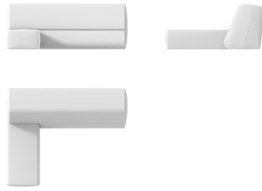

CHIMERBRAB090

I Schienale con bracciolo destro o sinistro per elemento di seduta cm. 180.
 E Backrest with right or left arm for seating element cm. 180.
 F Dossier avec accoudoir droit ou gauche pour élément d'assise cm. 180.
 D Ruecken mit Armlehne rechts oder links fuer Sitzung Element cm. 180.
 S Respaldo con brazo derecho o izquierdo para elemento de asiento cm. 180.

cm. 90 x 75 x h 35.5 • mt. 1.80
 in. 35¹/₂ x 39³/₄ x h 14" • yd. 1.95

COM	745,00
L	781,00
T	824,00
S	859,00
Z	902,00
K	937,00
PS	1.160,00
PF	1.297,00
PX	1.514,00
PA	1.719,00

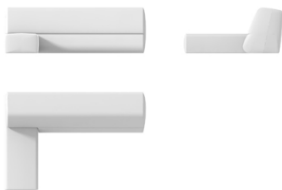

CHIMERBRAB105

I Schienale con bracciolo destro o sinistro per elemento di seduta cm. 210.
 E Backrest with right or left arm for seating element cm. 210.
 F Dossier avec accoudoir droit ou gauche pour élément d'assise cm. 210.
 D Ruecken mit Armlehne rechts oder links fuer Sitzung Element cm. 210.
 S Respaldo con brazo derecho o izquierdo para elemento de asiento cm. 210.

cm. 105 x 75 x h 35.5 • mt. 2.00
 in. 41¹/₂ x 39³/₄ x h 14" • yd. 2.20

COM	770,00
L	810,00
T	857,00
S	895,00
Z	942,00
K	982,00
PS	1.212,00
PF	1.360,00
PX	1.594,00
PA	1.815,00

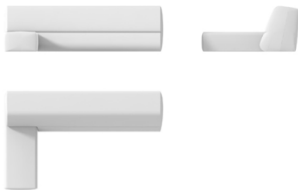

CHIMERBRAB120

I Schienale con bracciolo destro o sinistro per elemento di seduta cm. 240.
 E Backrest with right or left arm for seating element cm. 240.
 F Dossier avec accoudoir droit ou gauche pour élément d'assise cm. 240.
 D Ruecken mit Armlehne rechts oder links fuer Sitzung Element cm. 240.
 S Respaldo con brazo derecho o izquierdo para elemento de asiento cm. 240.

cm. 120 x 75 x h 35.5 • mt. 2.20
 in. 47¹/₂ x 39³/₄ x h 14" • yd. 2.40

COM	831,00
L	865,00
T	905,00
S	938,00
Z	979,00
K	1.012,00
PS	1.338,00
PF	1.499,00
PX	1.754,00
PA	1.994,00

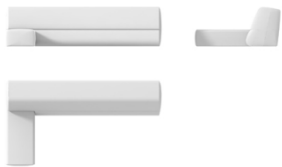

CHIMERBRAB135

I Schienale con bracciolo destro o sinistro per elemento di seduta cm. 270.
 E Backrest with right or left arm for seating element cm. 270.
 F Dossier avec accoudoir droit ou gauche pour élément d'assise cm. 270.
 D Ruecken mit Armlehne rechts oder links fuer Sitzung Element cm. 270.
 S Respaldo con brazo derecho o izquierdo para elemento de asiento cm. 270.

cm. 135 x 75 x h 35.5 • mt. 2.35
 in. 53¹/₂ x 39³/₄ x h 14" • yd. 2.60

COM	886,00
L	931,00
T	986,00
S	1.031,00
Z	1.086,00
K	1.131,00
PS	1.403,00
PF	1.576,00
PX	1.853,00
PA	2.113,00









CHIMERANGB090

I Schienale angolare destro o sinistro per elemento di seduta cm. 180.
 E Right or left corner backrest for seating element cm. 180.
 F Dossier d'angle droit ou gauche pour élément d'assise cm. 180.
 D Rechts oder links winklige Ruecken fuer Sitzung Element cm. 180.
 S Respaldo angular derecho o izquierdo para elemento de asiento cm. 180.





cm. 90 x 101 x h 35.5 • mt. 2.40
 in. 35¹/₂ x 39³/₄ x h 14" • yd. 2.60

COM	1.053,00
L	1.101,00
T	1.158,00
S	1.205,00
Z	1.263,00
K	1.310,00
PS	1.593,00
PF	1.775,00
PX	2.065,00
PA	2.338,00

CHIMERA - Design Matteo Nunziati

	<p>CHIMERANGB105</p> <p>I Schienale angolare destro o sinistro per elemento di seduta cm. 210. E Right or left corner backrest for seating element cm. 210. F Dossier d'angle droit ou gauche pour élément d'assise cm. 210. D Rechts oder links winklige Ruecken fuer Sitzung Element cm. 210. S Respaldo angular derecho o izquierdo para elemento de asiento cm. 210.</p>	<p>COM 1.080,00 L 1.132,00 T 1.193,00 S 1.243,00 Z 1.305,00 K 1.355,00 PS 1.648,00 PF 1.842,00 PX 2.150,00 PA 2.439,00</p>
	<p>cm. 105 x 101 x h 35.5 • mt. 2.60 in. 41³/₄ x 39³/₄ x h 14" • yd. 2.85</p>	
	<p>CHIMERANGB120</p> <p>I Schienale angolare destro o sinistro per elemento di seduta cm. 240. E Right or left corner backrest for seating element cm. 240. F Dossier d'angle droit ou gauche pour élément d'assise cm. 240. D Rechts oder links winklige Ruecken fuer Sitzung Element cm. 240. S Respaldo angular derecho o izquierdo para elemento de asiento cm. 240.</p>	<p>COM 1.144,00 L 1.198,00 T 1.263,00 S 1.317,00 Z 1.382,00 K 1.436,00 PS 1.762,00 PF 1.967,00 PX 2.296,00 PA 2.605,00</p>
	<p>cm. 120 x 101 x h 35.5 • mt. 2.75 in. 47¹/₄ x 39³/₄ x h 14" • yd. 3.00</p>	
	<p>CHIMERANGB135</p> <p>I Schienale angolare destro o sinistro per elemento di seduta cm. 270. E Right or left corner backrest for seating element cm. 270. F Dossier d'angle droit ou gauche pour élément d'assise cm. 270. D Rechts oder links winklige Ruecken fuer Sitzung Element cm. 270. S Respaldo angular derecho o izquierdo para elemento de asiento cm. 270.</p>	<p>COM 1.228,00 L 1.284,00 T 1.353,00 S 1.411,00 Z 1.479,00 K 1.537,00 PS 1.872,00 PF 2.088,00 PX 2.434,00 PA 2.758,00</p>
	<p>cm. 135 x 101 x h 35.5 • mt. 2.95 in. 53¹/₂ x 39³/₄ x h 14" • yd. 3.20</p>	
	<p>CHIMERSCHB090</p> <p>I Schienale diritto per elemento di seduta cm. 180. E Linear backrest for seating element cm. 180. F Dossier droit pour élément d'assise cm. 180. D Gerade Ruecken fuer Sitzung Element cm. 180. S Respaldo derecho para elemento de asiento cm. 180.</p>	<p>COM 573,00 L 603,00 T 639,00 S 670,00 Z 706,00 K 735,00 PS 895,00 PF 1.008,00 PX 1.188,00 PA 1.357,00</p>
	<p>cm. 90 x 31.5 x h 35.5 • mt. 1.55 in. 35¹/₂ x 12³/₄ x h 14" • yd. 1.70</p>	
	<p>CHIMERSCHB105</p> <p>I Schienale diritto per elemento di seduta cm. 210. E Linear backrest for seating element cm. 210. F Dossier droit pour élément d'assise cm. 210. D Gerade Ruecken fuer Sitzung Element cm. 210. S Respaldo derecho para elemento de asiento cm. 210.</p>	<p>COM 594,00 L 626,00 T 663,00 S 695,00 Z 732,00 K 764,00 PS 942,00 PF 1.064,00 PX 1.258,00 PA 1.439,00</p>
	<p>cm. 105 x 31.5 x h 35.5 • mt. 1.60 in. 41³/₄ x 12³/₄ x h 14" • yd. 1.75</p>	
	<p>CHIMERSCHB120</p> <p>I Schienale diritto per elemento di seduta cm. 240. E Linear backrest for seating element cm. 240. F Dossier droit pour élément d'assise cm. 240. D Gerade Ruecken fuer Sitzung Element cm. 240. S Respaldo derecho para elemento de asiento cm. 240.</p>	<p>COM 659,00 L 693,00 T 735,00 S 769,00 Z 812,00 K 846,00 PS 1.035,00 PF 1.165,00 PX 1.372,00 PA 1.567,00</p>
	<p>cm. 120 x 31.5 x h 35.5 • mt. 1.75 in. 47¹/₄ x 12³/₄ x h 14" • yd. 1.90</p>	

CHIMERA - Design Matteo Nunziati

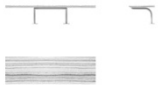
	<p>CHIMERSCHB135</p> <p>I Schienale diritto per elemento di seduta cm. 270. E Linear backrest for seating element cm. 270. F Dossier droit pour élément d'assise cm. 270. D Gerade Ruecken fuer Sitzung Element cm. 270. S Respaldo derecho para elemento de asiento cm. 270.</p> <p>cm. 135 x 31.5 x h 35.5 • mt. 1.90 in. 53¹/₂ x 12³/₈ x h 14¹/₂ • yd. 2.10</p>	COM	691,00
		L	729,00
		T	775,00
		S	813,00
		Z	858,00
		K	896,00
		PS	1.107,00
		PF	1.252,00
		PX	1.484,00
		PA	1.702,00
	<p>CHIMERCUSB065</p> <p>I Cuscino dello schienale cm.65. E Backrest pillow cm. 65. F Coussin de dossier cm. 65. D Ruecken Kissen cm. 65. S Cojín de respaldo cm. 65.</p> <p>cm. 65 x 22 x h 38 • mt. 0.80 in. 25³/₈ x 8³/₈ x h 15¹/₂ • yd. 0.90</p>	COM	249,00
		L	265,00
		T	284,00
		S	300,00
		Z	319,00
		K	334,00
		PS	417,00
		PF	478,00
		PX	576,00
		PA	667,00
	<p>CHIMERCUSB080</p> <p>I Cuscino dello schienale cm.80. E Backrest pillow cm. 80. F Coussin de dossier cm. 80. D Ruecken Kissen cm. 80. S Cojín de respaldo cm. 80.</p> <p>cm. 80 x 22 x h 38 • mt. 1.00 in. 31¹/₂ x 8³/₈ x h 15¹/₂ • yd. 1.10</p>	COM	268,00
		L	287,00
		T	311,00
		S	331,00
		Z	353,00
		K	373,00
		PS	468,00
		PF	541,00
		PX	658,00
		PA	768,00
	<p>CHIMERCUSB095</p> <p>I Cuscino dello schienale cm.95. E Backrest pillow cm. 95. F Coussin de dossier cm. 95. D Ruecken Kissen cm. 95. S Cojín de respaldo cm. 95.</p> <p>cm. 95 x 22 x h 38 • mt. 1.15 in. 37³/₈ x 8³/₈ x h 15¹/₂ • yd. 1.25</p>	COM	301,00
		L	323,00
		T	351,00
		S	374,00
		Z	401,00
		K	423,00
		PS	534,00
		PF	620,00
		PX	758,00
		PA	888,00
	<p>CHIMERCUSB110</p> <p>I Cuscino dello schienale cm.110. E Backrest pillow cm. 110. F Coussin de dossier cm. 110. D Ruecken Kissen cm. 110. S Cojín de respaldo cm. 110.</p> <p>cm. 110 x 22 x h 38 • mt. 1.30 in. 25³/₈ x 8³/₈ x h 15¹/₂ • yd. 0.90</p>	COM	336,00
		L	362,00
		T	392,00
		S	419,00
		Z	450,00
		K	476,00
		PS	602,00
		PF	700,00
		PX	860,00
		PA	1.009,00
	<p>CHIMERMENS085</p> <p>I Mensola cm. 85 in noce canaletto. E Shelf cm. 85 in black walnut wood. F Tablette cm. 85 en noyer d'Amérique. D Konsole cm. 85 in Amerikanische Nussbaumholz. S Estante cm. 85 en nogal Americano.</p> <p>cm. 85 x 25 x h 17 in. 33¹/₂ x 9³/₈ x h 6³/₈</p>		993,00

CHIMERA - Design Matteo Nunziati

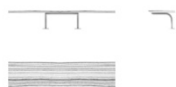

CHIMERMENS100

I Mensola cm. 100 in noce canaletto.
 E Shelf cm. 100 in black walnut wood.
 F Tablette cm. 100 en noyer d'Amérique.
 D Konsole cm. 100 in Amerikanische Nussbaumholz.
 S Estante cm. 100 en nogal Americano.

987,00

cm. 100 x 25 x h 17
 in. 39³/₈ x 9⁷/₈ x h 6⁷/₈



CHIMERMENS110

I Mensola cm. 110 in noce canaletto.
 E Shelf cm. 110 in black walnut wood.
 F Tablette cm. 110 en noyer d'Amérique.
 D Konsole cm. 110 in Amerikanische Nussbaumholz.
 S Estante cm. 110 en nogal Americano.

982,00

cm. 110 x 25 x h 17
 in. 43³/₈ x 9⁷/₈ x h 6⁷/₈

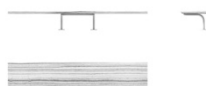

CHIMERMENS130

I Mensola cm. 130 in noce canaletto.
 E Shelf cm. 130 in black walnut wood.
 F Tablette cm. 130 en noyer d'Amérique.
 D Konsole cm. 130 in Amerikanische Nussbaumholz.
 S Estante cm. 130 en nogal Americano.

1.000,00

cm. 130 x 25 x h 17
 in. 51³/₈ x 9⁷/₈ x h 6⁷/₈

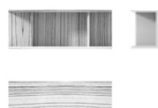

CHIMERMOBI095

I Mobile laterale cm. 95 in noce canaletto e cuoio.
 E Side open cabinet cm. 95 in black walnut wood and saddle leather.
 F Meuble lateral cm. 95 en noyer d'Amérique et cuir épais.
 D Seiten Schrank cm. 95 in Amerikanische Nussbaumholz und Rindleder.
 S Meuble lateral cm. 95 en nogal Americano y cuero.

1.883,00

cm. 95 x 25 x h 36
 in. 37³/₈ x 9⁷/₈ x h 14³/₈

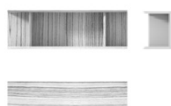

CHIMERMOBI110

I Mobile laterale cm. 110 in noce canaletto e cuoio.
 E Side open cabinet cm. 110 in black walnut wood and saddle leather.
 F Meuble lateral cm. 110 en noyer d'Amérique et cuir épais.
 D Seiten Schrank cm. 110 in Amerikanische Nussbaumholz und Rindleder.
 S Meuble lateral cm. 110 en nogal Americano y cuero.

1.889,00

cm. 110 x 25 x h 36
 in. 43³/₈ x 9⁷/₈ x h 14³/₈

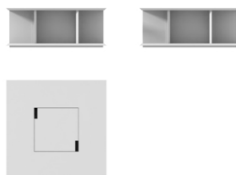

CHIMERTAVO090

I Tavolino in noce canaletto, cuoio e cristallo fumé.
 E Coffee table in black walnut wood, saddle leather and smoked glass.
 F Table basse en noyer d'Amérique, cuir épais et cristal fume.
 D Kaffee Tisch in Amerikanische Nussbaumholz, Rindleder und Rauch Glass.
 S Mesa centro en nogal Americano, cuero y cristal ahumado.

4.244,00

cm. 90 x 90 x h 36
 in. 35³/₈ x 35³/₈ x h 14³/₈

FELLINI - Design Umberto Asnago



Struttura. Lo schienale è in multistrato di pioppo. Il sedile è in legno massello di pioppo e faggio (stagionato "naturalmente" per almeno 3 anni) con elementi in multistrato di pioppo; giunzioni a incastro con spine cilindriche. Il molleggio è garantito da cinghie elastiche in polipropilene e lattice naturale. L'imbottitura del sedile è ottenuta con lastre di poliuretano espanso indeformabile a densità differenziate (30÷35 kg/m³) esente da CFC ricoperto da ovatta poliestere e vellutino accoppiato.

Cuscini. Cuscino di schienale in piuma canalizzata.

Braccioli. In legno massello di noce canaletto con finitura effetto cera.

Base. Piedini in PVC neri.

Rivestimento. Disponibile in tessuto e pelle; sfoderabile per i soli cuscini di schienale.

Piani. I piani di mensole laterali sono disponibili in marmo e cuoio.

Frame. The backrest frame is in polar plywood. The seat frame is in solid poplar and beech heartwood ("naturally" seasoned for at least 3 years) with connecting elements in poplar plywood; dap joints with cylindrical dowels. The webbing is secured by elastic polypropylene and natural latex belts. The seat frame is upholstered with contoured sheets of resilient, CFC-free polyurethane foam (with density of 30÷35 kg/m³) covered by polyester wadding and bonded plush.

Cushions. The back cushion is feather-filled.

Armrest. In solid black walnut heartwood with wax effect finishing.

Base. Supports in black PVC.

Covers. Available in fabric or leather; removable covers only for the back cushions.

Top. Top of side shelves available in marble and saddle leather.



FELLINPOLT107

- I Poltrona cm. 107.
- E Armchair cm. 107.
- F Fauteuil cm. 107.
- D Sessel cm. 107.
- S Butaca cm. 107.

cm. 107 x 95 x h 78 – hs 38 • mt. 4.40
in. 42¹/₂ x 37³/₈ x h 30³/₄ – hs 15" • yd. 4.80

COM	3.348,00
L	3.434,00
T	3.538,00
S	3.625,00
Z	3.729,00
K	3.815,00
PS	4.201,00
PF	4.531,00
PX	5.056,00
PA	5.550,00



FELLINPOLT122

- I Poltrona cm. 122.
- E Armchair cm. 122.
- F Fauteuil cm. 122.
- D Sessel cm. 122.
- S Butaca cm. 122.

cm. 122 x 95 x h 78 – hs 38 • mt. 5.50
in. 48" x 37³/₈ x h 30³/₄ – hs 15" • yd. 6.00

COM	3.504,00
L	3.612,00
T	3.742,00
S	3.850,00
Z	3.980,00
K	4.088,00
PS	4.566,00
PF	4.977,00
PX	5.634,00
PA	6.251,00







FELLINDIVA187

- I Divano 2 posti cm. 187.
- E 2 seater sofa cm. 187.
- F Canapé 2 places cm. 187.
- D Sofa 2-sitzig cm. 187.
- S Sofá de 2 plazas cm. 187.

cm. 187 x 95 x h 78 – hs 38 • mt. 9.40
in. 73³/₈ x 37³/₈ x h 30³/₄ – hs 15" • yd. 10.30

COM	4.528,00
L	4.711,00
T	4.932,00
S	5.116,00
Z	5.336,00
K	5.521,00
PS	6.306,00
PF	6.998,00
PX	8.106,00
PA	9.144,00

FELLINI - Design Umberto Asnago

	<p>FELLINDIVA217</p> <p>I Divano 2 posti cm. 217. E 2 seater sofa cm. 217. F Canapé 2 places cm. 217. D Sofa 2-sitzig cm. 217. S Sofá de 2 plazas cm. 217.</p>	<p>COM 4.775,00 L 4.970,00 T 5.203,00 S 5.397,00 Z 5.631,00 K 5.826,00 PS 6.663,00 PF 7.398,00 PX 8.576,00 PA 9.679,00</p>
<p>cm. 217 x 95 x h 78 – hs 38 • mt. 10.00 in. 85⁷/₈ x 37³/₈ x h 30³/₈ – hs 15” • yd. 10.95</p>		
	<p>FELLINDIVA267</p> <p>I Divano 3 posti cm. 267. E 3 seater sofa cm. 267. F Canapé 3 places cm. 267. D Sofa 3-sitzig cm. 267. S Sofá de 3 plazas cm. 267.</p>	<p>COM 5.471,00 L 5.709,00 T 5.995,00 S 6.233,00 Z 6.518,00 K 6.756,00 PS 7.800,00 PF 8.709,00 PX 10.162,00 PA 11.525,00</p>
<p>cm. 267 x 95 x h 78 – hs 38 • mt. 11.10 in. 105⁷/₈ x 37³/₈ x h 30³/₈ – hs 15” • yd. 12.15</p>		
	<p>FELLINDIVA312</p> <p>I Divano 3 posti cm. 312. E 3 seater sofa cm. 312. F Canapé 3 places cm. 312. D Sofa 3-sitzig cm. 312. S Sofá de 3 plazas cm. 312.</p>	<p>COM 5.870,00 L 6.130,00 T 6.441,00 S 6.700,00 Z 7.012,00 K 7.272,00 PS 8.391,00 PF 9.377,00 PX 10.956,00 PA 12.435,00</p>
<p>cm. 312 x 95 x h 78 – hs 38 • mt. 13.20 in. 122⁷/₈ x 37³/₈ x h 30³/₈ – hs 15” • yd. 14.45</p>		
	<p>FELLINTAVOLIN</p> <p>I Supplemento per tavolino laterale da posizionare al posto del bracciolo destro o sinistro. Piano in cuoio o marmo E Extra charge for side table to be placed in place of the armrest, left or right. Top in saddle leather or marble. F Supplément pour la petit table à la place de l'accoudoir droit ou gauche. Plan en cuir épais ou en marbre. D Ergänzung für den Beistelltisch anstelle der rechten oder linken Armlehne. Platte in Rindleder oder in Marmor. S Suplemento para que la mesa auxiliar se coloque en lugar del reposabrazos derecho o izquierdo. Tapa en cuero o en mármol.</p>	<p>722,00</p>
<p>cm. 34 x 91 x h 41 in. 13³/₈ x 35³/₈ x h 16³/₈</p>		

FUSION - Design Umberto Asnago



Struttura. In legno massello di pioppo (stagionato "naturalmente" per almeno 3 anni) con elementi in multistrato di pioppo; giunzioni a incastro con spine cilindriche. Il molleggio è garantito da cinghie elastiche in polipropilene e lattice naturale. L'imbottitura della struttura è ottenuta con lastre di poliuretano espanso indeformabile a densità differenziate (30÷35 kg/m³) esente da CFC ricoperto da ovatta poliester e vellutino accoppiato.

Cuscini. Cuscini di seduta divisi in 3 camere orizzontali: le due esterne sono in piuma canalizzata mentre nella centrale c'è una lastra di poliuretano (40 kg/m³); cuscini dei braccioli in piuma.

Braccioli. In tubolare d'acciaio disponibile in finitura cromata o verniciata a polveri epossidiche in colore RAL a scelta. Rivestimento in cuoio con dettaglio di stringa di cuoio disponibile nei colori bianco, nero, testa di moro, beige, naturale, blu, verde e rosso.

Base. Piedini in PVC rivestito in cuoio.

Rivestimento. Disponibile in tessuto e pelle; sfoderabile solo nella versione in tessuto.

Frame. In solid poplar heartwood ("naturally" seasoned for at least 3 years) with connecting elements in poplar plywood; dap joints with cylindrical dowels. The webbing is secured by elastic polypropylene and natural latex belts. The framework is upholstered with contoured sheets of resilient, CFC-free polyurethane foam (with density of 30÷35 kg/m³) covered by polyester wadding and bonded plush.

Cushions. The seat cushions are subdivided in 3 horizontal units: the two outside units are feather filled while in the central one there is a sheet of polyurethane foam (40 kg/m³); the armrest cushions are feather-filled.

Armrests. In tubular steel available chromed or epoxy powder painted in RAL colors of your choice. Covered in saddle leather with detail of saddle leather string available in color white, black, dark brown, beige, natural, blue, green and red.

Base. Feet in PVC covered in saddle leather.

Covers. Available in fabric or leather; removable covers only for fabric.

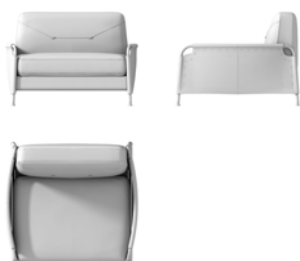

I Poltrona con braccioli in cuoietto (CS) o in cuoio (CF/CV).
 E Armchair with arms in saddle leather cat CS or CF/CV.
 F Fauteuil avec accoudoirs en cuir épais cat. CS ou CF/CV.
 D Sessel mit Armlehnen in Rindleder cat. CS oder CF/CV.
 S Butaca con brazos en cuero cat. CS o CF/CV.

cm. 112 x 110 x h 80 – hs 45 • mt. 5.50
 in. 44" x 43" x h 31" – hs 17" • yd. 6.00

	FUSIONCSPOLTR Cat. CS	FUSIONCFPOLTR Cat. CF	FUSIONCVPOLTR Cat. CV
COM	3.497,00	4.091,00	4.567,00
L	3.605,00	4.199,00	4.675,00
T	3.735,00	4.329,00	4.805,00
S	3.843,00	4.437,00	4.913,00
Z	3.973,00	4.567,00	5.043,00
K	4.081,00	4.675,00	5.151,00
PS	4.448,00	5.042,00	5.518,00
PF	4.837,00	5.431,00	5.907,00
PX	5.460,00	6.054,00	6.583,00
PA	6.044,00	6.638,00	7.114,00



I Divano 2 posti con braccioli in cuoietto (CS) o in cuoio (CF/CV).
 E 2 seater sofa with arms in saddle leather cat CS or CF/CV.
 F Canapé 2 places avec accoudoirs en cuir épais cat. CS ou CF/CV.
 D Sofa 2-sitzig mit Armlehnen in Rindleder cat. CS oder CF/CV.
 S Sofá de 2 plazas con brazos en cuero cat. CS o CF/CV.

cm. 207 x 110 x h 80 – hs 45 • mt. 9.35
 in. 81" x 43" x h 31" – hs 17" • yd. 10.20

	FUSIONCSDI200 Cat. CS	FUSIONCFDI200 Cat. CF	FUSIONCVDI200 Cat. CV
COM	4.295,00	4.889,00	5.365,00
L	4.478,00	5.074,00	5.550,00
T	4.700,00	5.294,00	5.770,00
S	4.883,00	5.479,00	5.954,00
Z	5.104,00	5.699,00	6.175,00
K	5.288,00	5.882,00	6.358,00
PS	5.919,00	6.515,00	6.991,00
PF	6.582,00	7.177,00	7.653,00
PX	7.641,00	8.236,00	8.712,00
PA	8.633,00	9.229,00	9.705,00

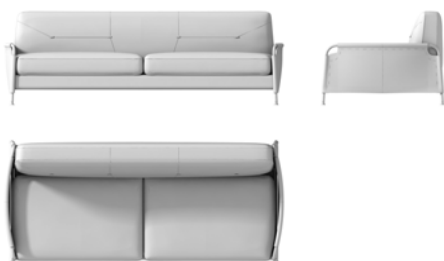

I Divano 3 posti con braccioli in cuoietto (CS) o in cuoio (CF/CV).
 E 3 seater sofa with arms in saddle leather cat CS or CF/CV.
 F Canapé 3 places avec accoudoirs en cuir épais cat. CS ou CF/CV.
 D Sofa 3-sitzig mit Armlehnen in Rindleder cat. CS oder CF/CV.
 S Sofá de 3 plazas con brazos en cuero cat. CS o CF/CV.

cm. 237 x 110 x h 80 – hs 45 • mt. 10.45
 in. 93" x 43" x h 31" – hs 17" • yd. 11.45

	FUSIONCSDI230 Cat. CS	FUSIONCFDI230 Cat. CF	FUSIONCVDI230 Cat. CV
COM	4.513,00	5.108,00	5.584,00
L	4.718,00	5.314,00	5.790,00
T	4.965,00	5.560,00	6.036,00
S	5.171,00	5.765,00	6.241,00
Z	5.417,00	6.012,00	6.488,00
K	5.623,00	6.217,00	6.693,00
PS	6.329,00	6.925,00	7.401,00
PF	7.070,00	7.664,00	8.140,00
PX	8.253,00	8.904,00	9.380,00
PA	9.363,00	9.958,00	10.434,00

FUSION - Design Umberto Asnago



FUSIONCSDI270
Cat. CS

I Divano 4 posti con braccioli in cuoietto (CS) o in cuoio (CF/CV).
E 4 seater sofa with arms in saddle leather cat CS or CF/CV.
F Canapé 4 places avec accoudoirs en cuir épais cat. CS ou CF/CV.
D Sofa 4-sitzig mit Armlehnen in Rindleder cat. CS oder CF/CV.
S Sofá de 4 plazas con brazos en cuero cat. CS o CF/CV.

cm. 272 x 110 x h 80 – hs 45 • mt. 12.10
in. 107¹/₄ x 43³/₄ x h 31¹/₂ – hs 17³/₄ • yd. 13.25

FUSIONCFDI270
Cat. CF

COM 4.836,00
L 5.074,00
T 5.359,00
S 5.597,00
Z 5.882,00
K 6.120,00
PS 6.691,00
PF 7.470,00
PX 8.716,00
PA 9.884,00

FUSIONCFDI270
Cat. CF

COM 5.430,00
L 5.668,00
T 5.954,00
S 6.192,00
Z 6.452,00
K 6.716,00
PS 7.286,00
PF 8.065,00
PX 9.310,00
PA 10.478,00

FUSIONCVDI270
Cat. CV

COM 5.906,00
L 6.144,00
T 6.430,00
S 6.668,00
Z 6.954,00
K 7.191,00
PS 7.762,00
PF 8.541,00
PX 9.786,00
PA 10.954,00



FUSIONCSCHADX
Cat. CS

I Chaiselongue destra con bracciolo in cuoietto (CS) o in cuoio (CF/CV).
E Right chaiselongue with arm in saddle leather cat CS or CF/CV.
F Dormeuse droite avec accoudoir en cuir épais cat. CS ou CF/CV.
D Chaiselongue rechts mit Armlehne Gestell in Rindleder cat. CS oder CF/CV.
S Chaise longue con rincón derecho con brazo en cuero cat. CS o CF/CV.

cm. 92 x 185 x h 80 – hs 45 • mt. 7.70
in. 36³/₄ x 72³/₄ x h 31¹/₂ – hs 17³/₄ • yd. 8.45

FUSIONCSCHADX
Cat. CS

COM 3.094,00
L 3.246,00
T 3.427,00
S 3.578,00
Z 3.761,00
K 3.912,00
PS 4.429,00
PF 4.974,00
PX 5.846,00
PA 6.663,00

FUSIONCFCHADX
Cat. CF

COM 3.397,00
L 3.548,00
T 3.730,00
S 3.881,00
Z 4.063,00
K 4.215,00
PS 4.732,00
PF 5.277,00
PX 6.149,00
PA 6.966,00

FUSIONCVCHADX
Cat. CV

COM 3.639,00
L 3.790,00
T 3.973,00
S 4.124,00
Z 4.305,00
K 4.457,00
PS 4.974,00
PF 5.519,00
PX 6.391,00
PA 7.209,00



FUSIONSCHASX
Cat. CS

I Chaiselongue sinistra con bracciolo in cuoietto (CS) o in cuoio (CF/CV).
E Left chaiselongue with arm in saddle leather cat CS or CF/CV.
F Dormeuse gauche avec accoudoir en cuir épais cat. CS ou CF/CV.
D Chaiselongue links mit Armlehne in Rindleder cat. CS oder CF/CV.
S Chaise longue con rincón izquierdo con brazo en cuero cat. CS o CF/CV.

cm. 92 x 185 x h 80 – hs 45 • mt. 7.70
in. 36³/₄ x 72³/₄ x h 31¹/₂ – hs 17³/₄ • yd. 8.45

FUSIONSCHASX
Cat. CS

COM 3.094,00
L 3.246,00
T 3.427,00
S 3.578,00
Z 3.761,00
K 3.912,00
PS 4.429,00
PF 4.974,00
PX 5.846,00
PA 6.663,00

FUSIONCFCHASX
Cat. CF

COM 3.397,00
L 3.548,00
T 3.730,00
S 3.881,00
Z 4.063,00
K 4.215,00
PS 4.732,00
PF 5.277,00
PX 6.149,00
PA 6.966,00

FUSIONCVCHASX
Cat. CV

COM 3.639,00
L 3.790,00
T 3.973,00
S 4.124,00
Z 4.305,00
K 4.457,00
PS 4.974,00
PF 5.519,00
PX 6.391,00
PA 7.209,00

GARBO - Design Umberto Asnago



Struttura. In multistrato di faggio curvato in stampo. L'imbottitura dello schienale e dei braccioli è realizzata tramite elementi in poliuretano espanso, schiumati a freddo tramite opportuni stampi e incollati alla struttura. La schiuma poliuretana soddisfa la classe 1 IM di resistenza al fuoco secondo la legge italiana ed è disponibile anche secondo altri standard internazionali. La parte esterna è disponibile rivestita in pelle o tessuto oppure in essenza di noce canaletto o tipo ebano.

Cuscini. Cuscino di seduta in poliuretano espanso indeformabile esente da CFC ricoperto da ovatta poliestere.

Base. Basamento girevole a 4 razze con pistone a gas, disponibile in finitura cromata o verniciata a polveri epossidiche in colore RAL a scelta.

Rivestimento. Disponibile in tessuto e pelle; non sfoderabile.

Frame. In beech plywood panel curved into a mould. The backrest and armrests frame is upholstered with cold formed polyurethane parts made in mould, glued to the frame. The foam complies with the Italian Classe 1IM fire resistant law and is available on request for other international standards. The outside part of the backrest and armrests is available covered in fabric or leather or veneered in black walnut wood or in ebony type wood.

Cushions. Seat cushion in resilient polyurethane foam CFC-free covered by polyester wadding.

Base. Swivel 4 star base with gas-piston, available chromed or epoxy powder painted in RAL colors of your choice.

Covers. Available in fabric or leather; non removable covers.



GARBOORELAXIM

I Poltrona relax girevole con base cromata nera.
 E Relax armchair with swivel black chromed base
 F Fauteuil relax tournant avec piétement chromé noir.
 D Drehsessel relax mit schwarz verchromtem Fuss.
 S Sillón relax giratorio con base cromada negra.

cm. 86 x 92 x h 88 – hs 41 • mt. 4.95
 in. 33³/₄ x 36³/₄ x h 34³/₄ – hs 16³/₄ • yd. 5.40

COM	2.824,00
L	2.913,00
T	3.021,00
S	3.111,00
Z	3.219,00
K	3.308,00
PS	3.549,00
PF	3.838,00
PX	4.301,00
PA	4.735,00



GARBOORELAXES

I Poltrona relax girevole con base cromata nera; parte esterna dello schienale e dei braccioli in noce canaletto.
 E Relax armchair with swivel black chromed base; outside of the back and the armpads in black walnut wood.
 F Fauteuil relax tournant avec piétement chromé noir; partie extérieure du dossier et des accoudoirs en noyer d'Amerique.
 D Drehsessel relax mit schwarz verchromtem Fuss; aussen Teil von der Rückenlehne und Armlehnen in Amerikanische Nussbaum.
 S Sillón relax giratorio con base cromada negra; parte externa del respaldo y de los brazos acabada en nogal americano.

cm. 86 x 92 x h 88 – hs 41 • mt. 3.55
 in. 33³/₄ x 36³/₄ x h 34³/₄ – hs 16³/₄ • yd. 3.90

COM	3.300,00
L	3.364,00
T	3.441,00
S	3.504,00
Z	3.581,00
K	3.645,00
PS	3.863,00
PF	4.082,00
PX	4.433,00
PA	4.762,00



GARBOORELAXLA

I Poltrona relax girevole con base cromata nera; parte esterna dello schienale e dei braccioli laccata in colore RAL a scelta.
 E Relax armchair with swivel black chromed base; outside of the back and the armpads lacquered in RAL colour at client's choice.
 F Fauteuil relax tournant avec piétement chromé noir; partie extérieure du dossier et des accoudoirs lacquée en couleur RAL choisi par le client.
 D Drehsessel relax mit schwarz verchromtem Fuss; aussen Teil von der Rückenlehne und Armlehnen in lackiert in RAL Farbe nach Wahl.
 S Sillón relax giratorio con base cromada negra; parte externa del respaldo y de los brazos pintada en color RAL elegido por el cliente.

cm. 86 x 92 x h 88 – hs 41 • mt. 3.55
 in. 33³/₄ x 36³/₄ x h 34³/₄ – hs 16³/₄ • yd. 3.90

COM	3.216,00
L	3.284,00
T	3.364,00
S	3.431,00
Z	3.512,00
K	3.579,00
PS	3.775,00
PF	4.006,00
PX	4.375,00
PA	4.722,00

GARBO - Design Umberto Asnago



GARBOPOUFFIM

I Pouff con base cromata nera.
 E Ottoman with black chromed base
 F Pouf avec pietément chromé noir.
 D Hocker mit schwarz verchromtem Fuss.
 S Pouf con base cromada negra.

cm. 54 x 51 x h 42 – hs 42 • mt. 1.10
 in. 21”¼ x 20”¼ x h 16”½ – hs 16”½ • yd. 1.20

COM	1.248,00
L	1.269,00
T	1.294,00
S	1.315,00
Z	1.341,00
K	1.362,00
PS	1.446,00
PF	1.522,00
PX	1.643,00
PA	1.756,00



GARBOPOUFFES

I Pouff con base cromata nera; parte esterna in noce canaletto.
 E Ottoman with swivel black chromed base; outside in black walnut wood .
 F Pouf avec pietément chromé noir; partie extérieure en noyer d’Amerique.
 D Hocker mit schwarz verchromtem Fuss; aussen Teil in Amerikanische Nussbaum.
 S Pouf con base cromada negra; parte externa acabada en nogal americano.

cm. 54 x 51 x h 42 – hs 42 • mt. 0.80
 in. 21”¼ x 20”¼ x h 16”½ – hs 16”½ • yd. 0.88

COM	1.372,00
L	1.387,00
T	1.405,00
S	1.419,00
Z	1.437,00
K	1.452,00
PS	1.492,00
PF	1.539,00
PX	1.613,00
PA	1.682,00



GARBOPOUFFLA

I Pouff con base cromata nera; parte esterna laccata in colore RAL a scelta del cliente.
 E Ottoman with swivel black chromed base; outside lacquered in RAL colour at client’s choice.
 F Pouf avec pietément chromé noir; partie extérieure lacquée en couleur RAL choisi par le client.
 D Hocker mit schwarz verchromtem Fuss; aussen Teil in lackiert in RAL Farbe nach Wahl.
 S Pouf con base cromada negra; parte externa pintada en color RAL elegido por el cliente.

cm. 54 x 51 x h 42 – hs 42 • mt. 0.80
 in. 21”¼ x 20”¼ x h 16”½ – hs 16”½ • yd. 0.88

COM	1.305,00
L	1.320,00
T	1.338,00
S	1.352,00
Z	1.370,00
K	1.385,00
PS	1.425,00
PF	1.471,00
PX	1.545,00
PA	1.615,00

GIOTTO - Design Umberto Asnago



Base. Basamento in multistrato di faggio curvato in stampo, verniciato in colore titanio.
Piano. In marmo appoggiato su lastra di acciaio verniciato nero, con distanziale in legno massello di noce canaletto.

Base. In beech plywood curved into a mould, painted in titanium color.
Top. In marble fixed to a metal sheet epoxy powder black painted, with a spacer in black walnut heartwood.



GIOTTOTA090MC

I Tavolino ovale cm. 90x66 con basamento verniciato titanio e piano in marmo calacatta oro.
E Oval coffee table cm. 90x66 with base varnished in titanium color and top in Calacatta Oro marble.
F Table basse ovale cm. 90x66 avec piètement verni en couleur titane et plan en marbre Calacatta Oro.
D Ovaler Tisch cm. 90x66 mit lackiertem titanium Farbe Fuss und Platte in Calacatta Oro Marmor.
S Mesa centro ovalada cm. 90x66 con base pintanda en color de titanio y tapa de mármol Calacatta Oro.

3.231,00

cm. 90 x 66 x h 25
 in. 35¹/₂ x 26¹/₂ x h 9³/₄

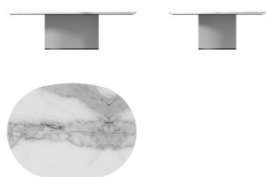

GIOTTOTA120MC

I Tavolino ovale cm. 120x90 con basamento verniciato titanio e piano in marmo calacatta oro.
E Oval coffee table cm. 120x90 with base varnished in titanium color and top in Calacatta Oro marble.
F Table basse ovale cm. 120x90 avec piètement verni en couleur titane et plan en marbre Calacatta Oro.
D Ovaler Tisch cm. 120x90 mit lackiertem titanium Farbe Fuss und Platte in Calacatta Oro Marmor.
S Mesa centro ovalada cm. 120x90 con base pintanda en color de titanio y tapa de mármol Calacatta Oro.

4.464,00

cm. 120 x 90 x h 35
 in. 47¹/₄ x 35¹/₂ x h 13³/₄

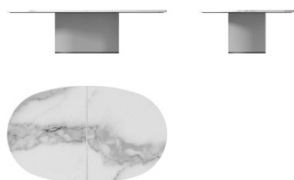

GIOTTOTA150MC

I Tavolino ovale cm. 150x90 con basamento verniciato titanio e piano in marmo calacatta oro.
E Oval coffee table cm. 150x90 with base varnished in titanium color and top in Calacatta Oro marble.
F Table basse ovale cm. 150x90 avec piètement verni en couleur titane et plan en marbre Calacatta Oro.
D Ovaler Tisch cm. 150x90 mit lackiertem titanium Farbe Fuss und Platte in Calacatta Oro Marmor.
S Mesa centro ovalada cm. 150x90 con base pintanda en color de titanio y tapa de mármol Calacatta Oro.

5.130,00

cm. 150 x 90 x h 40
 in. 59¹/₂ x 35¹/₂ x h 15³/₄

GLACE' - Design Mauro Lipparini



Struttura. In legno massello di pioppo (stagionato "naturalmente" per almeno 3 anni) con elementi in pannelli di particelle di legno; giunzioni a incastro con spine cilindriche. Il molleggio è garantito da cinghie elastiche in polipropilene e lattice naturale. L'imbottitura della struttura è ottenuta con lastre di poliuretano espanso indeformabile con densità di 75 kg/m³ esente da CFC ricoperto da ovatta poliestere e vellutino accoppiato.

Cuscini. Cuscini di seduta in poliuretano espanso a densità differenziate (con densità di 30÷35 kg/m³) ed esente da CFC. I cuscini di schienale sono completamente in piuma canalizzata.

Base. Piedini PVC nero

Rivestimento. Disponibile in tessuto e pelle; sfoderabile solo nella versione in tessuto.

Frame. In solid poplar heartwood ("naturally" seasoned for at least 3 years) with connecting elements in particleboard panel; dap joints with cylindrical dowels. The webbing is secured by elastic polypropylene and natural latex belts. The framework is upholstered with contoured sheets of resilient, CFC-free polyurethane foam with density of 70 kg/m³ covered by polyester wadding and bonded plush.

Cushions. The seat cushions are in polyurethane foam with different density of 30÷35 kg/m³. The back cushions are feather-filled.

Base. Supports in black PVC.

Covers. Available in fabric or leather; removable covers only for fabric version.

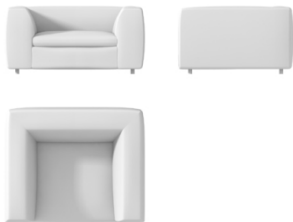

GLACE0POLT130

I Poltrona.
E Armchair.
F Fauteuil.
D Sessel.
S Butaca.

cm. 130 x 102 x h 61.5 – hs 40 • mt. 6.10
in. 51¹/₄ x 40¹/₄ x h 24³/₄ – hs 15³/₄ • yd. 6.70

COM	2.038,00
L	2.163,00
T	2.313,00
S	2.438,00
Z	2.588,00
K	2.713,00
PS	3.355,00
PF	3.805,00
PX	4.525,00
PA	5.198,00



GLACE0CENT100

I Elemento centrale.
E Central unit.
F Élément central.
D Zentral Element.
S Módulo central.

cm. 100 x 102 x h 61.5 – hs 40 • mt. 4.40
in. 39³/₄ x 40¹/₄ x h 24³/₄ – hs 15³/₄ • yd. 4.80

COM	1.694,00
L	1.785,00
T	1.894,00
S	1.985,00
Z	2.094,00
K	2.185,00
PS	2.649,00
PF	2.976,00
PX	3.499,00
PA	3.990,00



GLACE0DIVA180

I Divano 2 posti cm. 180.
E 2 seater sofa cm. 180.
F Canapé 2 places cm. 180.
D Sofa 2-sitzig cm. 180.
S Sofá de 2 plazas 180.

cm. 180 x 102 x h 61.5 – hs 40 • mt. 8.80
in. 70³/₄ x 40¹/₄ x h 24³/₄ – hs 15³/₄ • yd. 9.60

COM	2.577,00
L	2.758,00
T	2.977,00
S	3.158,00
Z	3.376,00
K	3.558,00
PS	4.433,00
PF	5.087,00
PX	6.134,00
PA	7.114,00



GLACE0D158BDX

I Divano 2 posti cm. 158, con bracciolo destro.
E 2 seater sofa cm. 158, with right arm.
F Canapé 2 places cm. 158, avec accoudoir droit.
D Sofa 2-sitzig cm. 158, mit rechter Armlehne.
S Sofá de 2 plazas 158, con brazo derecho.

cm. 158 x 102 x h 61.5 – hs 40 • mt. 7.70
in. 62³/₄ x 40¹/₄ x h 24³/₄ – hs 15³/₄ • yd. 8.40

COM	2.306,00
L	2.465,00
T	2.655,00
S	2.814,00
Z	3.006,00
K	3.164,00
PS	3.926,00
PF	4.498,00
PX	5.415,00
PA	6.273,00

GLACE' - Design Mauro Lipparini

	<p>GLACE0D158BSX</p> <p>I Divano 2 posti cm. 158, con bracciolo sinistro. E 2 seater sofa cm. 158, with left arm. F Canapé 2 places cm. 158, avec accoudoir gauche. D Sofa 2-sitzig cm. 158, mit linker Armlehne. S Sofá de 2 plazas 158, con brazo izquierdo.</p>	<p>COM 2.306,00 L 2.465,00 T 2.655,00 S 2.814,00 Z 3.006,00 K 3.164,00 PS 3.926,00 PF 4.498,00 PX 5.415,00 PA 6.273,00</p>
	<p>GLACE0D164ADX</p> <p>I Divano 2 posti cm. 164, con angolo destro. E 2 seater sofa cm. 164, with right angle. F Canapé 2 places cm. 164, avec angle droit. D Sofa 2-sitzig cm. 164, mit Winkel rechts. S Sofá de 2 plazas 164, con rincón derecho.</p>	<p>COM 2.342,00 L 2.501,00 T 2.691,00 S 2.851,00 Z 3.042,00 K 3.200,00 PS 3.962,00 PF 4.535,00 PX 5.451,00 PA 6.309,00</p>
	<p>GLACE0D164ASX</p> <p>I Divano 2 posti cm. 164, con angolo sinistro. E 2 seater sofa cm. 164, with left angle. F Canapé 2 places cm. 164, avec angle gauche. D Sofa 2-sitzig cm. 164, mit Winkel links. S Sofá de 2 plazas 164, con rincón izquierdo.</p>	<p>COM 2.342,00 L 2.501,00 T 2.691,00 S 2.851,00 Z 3.042,00 K 3.200,00 PS 3.962,00 PF 4.535,00 PX 5.451,00 PA 6.309,00</p>
	<p>GLACE0D186ADX</p> <p>I Divano 2 posti cm. 186, con bracciolo sinistro ed angolo destro. E 2 seater sofa cm. 186, with left arm and right angle. F Canapé 2 places cm. 186, avec accoudoir gauche et angle droit. D Sofa 2-sitzig cm. 186, mit linker Armlehne und Winkel rechts. S Sofá de 2 plazas 186, con brazo izquierdo y rincón derecho.</p>	<p>COM 2.615,00 L 2.796,00 T 3.015,00 S 3.196,00 Z 3.414,00 K 3.596,00 PS 4.471,00 PF 5.125,00 PX 6.172,00 PA 7.152,00</p>
	<p>GLACE0D186ASX</p> <p>I Divano 2 posti cm. 186, con bracciolo destro ed angolo sinistro. E 2 seater sofa cm. 186, with right arm and left angle. F Canapé 2 places cm. 186, avec accoudoir droit et angle gauche. D Sofa 2-sitzig cm. 186, mit rechter Armlehne und Winkel links. S Sofá de 2 plazas 186, con brazo derecho y rincón izquierdo.</p>	<p>COM 2.615,00 L 2.796,00 T 3.015,00 S 3.196,00 Z 3.414,00 K 3.596,00 PS 4.471,00 PF 5.125,00 PX 6.172,00 PA 7.152,00</p>
	<p>GLACE0DIVA210</p> <p>I Divano 2 posti cm. 210. E 2 seater sofa cm. 210. F Canapé 2 places cm. 210. D Sofa 2-sitzig cm. 210. S Sofá de 2 plazas 210.</p>	<p>COM 2.914,00 L 3.118,00 T 3.364,00 S 3.568,00 Z 3.813,00 K 4.018,00 PS 5.027,00 PF 5.763,00 PX 6.940,00 PA 8.044,00</p>

GLACE' - Design Mauro Lipparini



GLACE0D188BDX

I Divano 2 posti cm. 188, con bracciolo destro.
 E 2 seater sofa cm. 188, with right arm.
 F Canapé 2 places cm. 188, avec accoudoir droit.
 D Sofa 2-sitzig cm. 188, mit rechter Armlehne.
 S Sofá de 2 plazas 188, con brazo derecho.

cm. 188 x 102 x h 61.5 – hs 40 • mt. 8.80
 in. 74" x 40"½ x h 24"¼ – hs 15"¾ • yd. 9.60

COM	2.622,00
L	2.804,00
T	3.022,00
S	3.203,00
Z	3.422,00
K	3.603,00
PS	4.501,00
PF	5.155,00
PX	6.202,00
PA	7.183,00



GLACE0D188BSX

I Divano 2 posti cm. 188, con bracciolo sinistro.
 E 2 seater sofa cm. 188, with left arm.
 F Canapé 2 places cm. 188, avec accoudoir gauche.
 D Sofa 2-sitzig cm. 188, mit linker Armlehne.
 S Sofá de 2 plazas 188, con brazo izquierdo.

cm. 188 x 102 x h 61.5 – hs 40 • mt. 8.80
 in. 74" x 40"½ x h 24"¼ – hs 15"¾ • yd. 9.60

COM	2.622,00
L	2.804,00
T	3.022,00
S	3.203,00
Z	3.422,00
K	3.603,00
PS	4.501,00
PF	5.155,00
PX	6.202,00
PA	7.183,00



GLACE0D194ADX

I Divano 2 posti cm. 194, con angolo destro.
 E 2 seater sofa cm. 194, with right angle.
 F Canapé 2 places cm. 194, avec angle droit.
 D Sofa 2-sitzig cm. 194, mit Winkel rechts.
 S Sofá de 2 plazas 194, con rincón derecho.

cm. 194 x 102 x h 61.5 – hs 40 • mt. 8.80
 in. 76"¾ x 40"½ x h 24"¼ – hs 15"¾ • yd. 9.60

COM	2.698,00
L	2.880,00
T	3.097,00
S	3.280,00
Z	3.498,00
K	3.679,00
PS	4.577,00
PF	5.231,00
PX	6.278,00
PA	7.259,00



GLACE0D194ASX

I Divano 2 posti cm. 194, con angolo sinistro.
 E 2 seater sofa cm. 194, with left angle.
 F Canapé 2 places cm. 194, avec angle gauche.
 D Sofa 2-sitzig cm. 194, mit Winkel links.
 S Sofá de 2 plazas 194, con rincón izquierdo.

cm. 194 x 102 x h 61.5 – hs 40 • mt. 8.80
 in. 76"¾ x 40"½ x h 24"¼ – hs 15"¾ • yd. 9.60

COM	2.698,00
L	2.880,00
T	3.097,00
S	3.280,00
Z	3.498,00
K	3.679,00
PS	4.577,00
PF	5.231,00
PX	6.278,00
PA	7.259,00



GLACE0D216ADX

I Divano 2 posti cm. 216, con bracciolo sinistro ed angolo destro.
 E 2 seater sofa cm. 216, with left arm and right angle.
 F Canapé 2 places cm. 216, avec accoudoir gauche et angle droit.
 D Sofa 2-sitzig cm. 216, mit linker Armlehne und Winkel rechts.
 S Sofá de 2 plazas 216, con brazo izquierdo y rincón derecho.

cm. 216 x 102 x h 61.5 – hs 40 • mt. 9.90
 in. 85" x 40"½ x h 24"¼ – hs 15"¾ • yd. 10.85

COM	2.946,00
L	3.151,00
T	3.396,00
S	3.600,00
Z	3.845,00
K	4.050,00
PS	5.059,00
PF	5.795,00
PX	6.972,00
PA	8.076,00



GLACE0D216ASX

I Divano 2 posti cm. 216, con bracciolo destro ed angolo sinistro.
 E 2 seater sofa cm. 216, with right arm and left angle.
 F Canapé 2 places cm. 216, avec accoudoir droit et angle gauche.
 D Sofa 2-sitzig cm. 216, mit rechter Armlehne und Winkel links.
 S Sofá de 2 plazas 216, con brazo derecho y rincón izquierdo.

cm. 216 x 102 x h 61.5 – hs 40 • mt. 9.90
 in. 85" x 40"½ x h 24"¼ – hs 15"¾ • yd. 10.85

COM	2.946,00
L	3.151,00
T	3.396,00
S	3.600,00
Z	3.845,00
K	4.050,00
PS	5.059,00
PF	5.795,00
PX	6.972,00
PA	8.076,00

GLACE' - Design Mauro Lipparini



GLACE0DIVA240

I Divano 2 posti cm. 240.
E 2 seater sofa cm. 240.
F Canapé 2 places cm. 240.
D Sofa 2-sitzig cm. 240.
S Sofá de 2 plazas 240.

cm. 240 x 102 x h 61.5 – hs 40 • mt. 11.00
in. 94”½ x 40”¼ x h 24”¼ – hs 15”¾ • yd. 12.05

COM	3.229,00
L	3.456,00
T	3.729,00
S	3.955,00
Z	4.228,00
K	4.456,00
PS	5.559,00
PF	6.377,00
PX	7.685,00
PA	8.912,00



GLACE0D218BDX

I Divano 2 posti cm. 218, con bracciolo destro.
E 2 seater sofa cm. 218, with right arm.
F Canapé 2 places cm. 218, avec accoudoir droit.
D Sofa 2-sitzig cm. 218, mit rechter Armlehne.
S Sofá de 2 plazas 218, con brazo derecho.

cm. 218 x 102 x h 61.5 – hs 40 • mt. 9.90
in. 85”¾ x 40”¼ x h 24”¼ – hs 15”¾ • yd. 10.85

COM	2.898,00
L	3.102,00
T	3.348,00
S	3.552,00
Z	3.798,00
K	4.002,00
PS	4.992,00
PF	5.729,00
PX	6.906,00
PA	8.009,00



GLACE0D218BSX

I Divano 2 posti cm. 218, con bracciolo sinistro.
E 2 seater sofa cm. 218, with left arm.
F Canapé 2 places cm. 218, avec accoudoir gauche.
D Sofa 2-sitzig cm. 218, mit linker Armlehne.
S Sofá de 2 plazas 218, con brazo izquierdo.

cm. 218 x 102 x h 61.5 – hs 40 • mt. 9.90
in. 85”¾ x 40”¼ x h 24”¼ – hs 15”¾ • yd. 10.85

COM	2.898,00
L	3.102,00
T	3.348,00
S	3.552,00
Z	3.798,00
K	4.002,00
PS	4.992,00
PF	5.729,00
PX	6.906,00
PA	8.009,00



GLACE0D224ADX

I Divano 2 posti cm. 224, con angolo destro.
E 2 seater sofa cm. 224, with right angle.
F Canapé 2 places cm. 224, avec angle droit.
D Sofa 2-sitzig cm. 224, mit Winkel rechts.
S Sofá de 2 plazas 224, con rincón derecho.

cm. 224 x 102 x h 61.5 – hs 40 • mt. 9.90
in. 88”¾ x 40”¼ x h 24”¼ – hs 15”¾ • yd. 10.85

COM	2.934,00
L	3.138,00
T	3.385,00
S	3.589,00
Z	3.834,00
K	4.039,00
PS	5.029,00
PF	5.765,00
PX	6.980,00
PA	8.084,00



GLACE0D224ASX

I Divano 2 posti cm. 224, con angolo sinistro.
E 2 seater sofa cm. 224, with left angle.
F Canapé 2 places cm. 224, avec angle gauche.
D Sofa 2-sitzig cm. 224, mit Winkel links.
S Sofá de 2 plazas 224, con rincón izquierdo.

cm. 224 x 102 x h 61.5 – hs 40 • mt. 9.90
in. 88”¾ x 40”¼ x h 24”¼ – hs 15”¾ • yd. 10.85

COM	2.934,00
L	3.138,00
T	3.385,00
S	3.589,00
Z	3.834,00
K	4.039,00
PS	5.029,00
PF	5.765,00
PX	6.980,00
PA	8.084,00



GLACE0D246ADX

I Divano 2 posti cm. 246, con bracciolo sinistro ed angolo destro.
E 2 seater sofa cm. 246, with left arm and right angle.
F Canapé 2 places cm. 246, avec accoudoir gauche et angle droit.
D Sofa 2-sitzig cm. 246, mit linker Armlehne und Winkel rechts.
S Sofá de 2 plazas 246, con brazo izquierdo y rincón derecho.

cm. 246 x 102 x h 61.5 – hs 40 • mt. 11.00
in. 96”¾ x 40”¼ x h 24”¼ – hs 15”¾ • yd. 12.05

COM	3.601,00
L	3.829,00
T	4.100,00
S	4.328,00
Z	4.600,00
K	4.828,00
PS	5.970,00
PF	6.787,00
PX	8.096,00
PA	9.322,00

GLACE' - Design Mauro Lipparini



GLACE0D246ASX

I Divano 2 posti cm. 246, con bracciolo destro ed angolo sinistro.
 E 2 seater sofa cm. 246, with right arm and left angle.
 F Canapé 2 places cm. 246, avec accoudoir droit et angle gauche.
 D Sofa 2-sitzig cm. 246, mit rechter Armlehne und Winkel links.
 S Sofá de 2 plazas 246, con brazo derecho y rincón izquierdo.

cm. 246 x 102 x h 61.5 – hs 40 • mt. 11.00
 in. 96³/₄ x 40¹/₂ x h 24¹/₄ – hs 15³/₄ • yd. 12.05

COM	3.601,00
L	3.829,00
T	4.100,00
S	4.328,00
Z	4.600,00
K	4.828,00
PS	5.970,00
PF	6.787,00
PX	8.096,00
PA	9.322,00



GLACE0DIVA270

I Divano 3 posti cm. 270.
 E 3 seater sofa cm. 270.
 F Canapé 3 places cm. 270.
 D Sofa 3-sitzig cm. 270.
 S Sofá de 3 plazas 270.

cm. 270 x 102 x h 61.5 – hs 40 • mt. 11.70
 in. 106¹/₄ x 40¹/₂ x h 24¹/₄ – hs 15³/₄ • yd. 12.80

COM	3.606,00
L	3.849,00
T	4.141,00
S	4.384,00
Z	4.675,00
K	4.918,00
PS	6.122,00
PF	6.999,00
PX	8.402,00
PA	9.716,00



GLACE0D248BDX

I Divano 3 posti cm. 248, con bracciolo destro.
 E 3 seater sofa cm. 248, with right arm.
 F Canapé 3 places cm. 248, avec accoudoir droit.
 D Sofa 3-sitzig cm. 248, mit rechter Armlehne.
 S Sofá de 3 plazas 248, con brazo derecho.

cm. 248 x 102 x h 61.5 – hs 40 • mt. 11.00
 in. 97³/₄ x 40¹/₂ x h 24¹/₄ – hs 15³/₄ • yd. 12.05

COM	3.301,00
L	3.522,00
T	3.786,00
S	4.006,00
Z	4.270,00
K	4.491,00
PS	5.582,00
PF	6.377,00
PX	7.649,00
PA	8.840,00



GLACE0D248BSX

I Divano 3 posti cm. 248, con bracciolo sinistro.
 E 3 seater sofa cm. 248, with left arm.
 F Canapé 3 places cm. 248, avec accoudoir gauche.
 D Sofa 3-sitzig cm. 248, mit linker Armlehne.
 S Sofá de 3 plazas 248, con brazo izquierdo.

cm. 248 x 102 x h 61.5 – hs 40 • mt. 11.00
 in. 97³/₄ x 40¹/₂ x h 24¹/₄ – hs 15³/₄ • yd. 12.05

COM	3.301,00
L	3.522,00
T	3.786,00
S	4.006,00
Z	4.270,00
K	4.491,00
PS	5.582,00
PF	6.377,00
PX	7.649,00
PA	8.840,00



GLACE0D254ADX

I Divano 3 posti cm. 254, con angolo destro.
 E 3 seater sofa cm. 254, with right angle.
 F Canapé 3 places cm. 254, avec angle droit.
 D Sofa 3-sitzig cm. 254, mit Winkel rechts.
 S Sofá de 3 plazas 254, con rincón derecho.

cm. 254 x 102 x h 61.5 – hs 40 • mt. 11.00
 in. 100¹/₂ x 40¹/₂ x h 24¹/₄ – hs 15³/₄ • yd. 12.05

COM	3.337,00
L	3.558,00
T	3.822,00
S	4.043,00
Z	4.306,00
K	4.527,00
PS	5.618,00
PF	6.413,00
PX	7.685,00
PA	8.877,00



GLACE0D254ASX

I Divano 3 posti cm. 254, con angolo sinistro.
 E 3 seater sofa cm. 254, with left angle.
 F Canapé 3 places cm. 254, avec angle gauche.
 D Sofa 3-sitzig cm. 254, mit Winkel links.
 S Sofá de 3 plazas 254, con rincón izquierdo.

cm. 254 x 102 x h 61.5 – hs 40 • mt. 11.00
 in. 100¹/₂ x 40¹/₂ x h 24¹/₄ – hs 15³/₄ • yd. 12.05

COM	3.337,00
L	3.558,00
T	3.822,00
S	4.043,00
Z	4.306,00
K	4.527,00
PS	5.618,00
PF	6.413,00
PX	7.685,00
PA	8.877,00

GLACE' - Design Mauro Lipparini



GLACE0D276ADX

I Divano 3 posti cm. 276, con bracciolo sinistro ed angolo destro.
 E 3 seater sofa cm. 276, with left arm and right angle.
 F Canapé 3 places cm. 276, avec accoudoir gauche et angle droite.
 D Sofa 3-sitzig cm. 276, mit linker Armlehne und Winkel rechts.
 S Sofá de 3 plazas 276, con brazo izquierdo y rincón derecho.

cm. 276 x 102 x h 61.5 – hs 40 • mt. 11.70
 in. 108³/₈ x 40¹/₈ x h 24³/₄ – hs 15³/₈ • yd. 12.80

COM	3.642,00
L	3.885,00
T	4.177,00
S	4.420,00
Z	4.711,00
K	4.954,00
PS	6.158,00
PF	7.035,00
PX	8.438,00
PA	9.753,00



GLACE0D276ASX

I Divano 3 posti cm. 276, con bracciolo destro ed angolo sinistro.
 E 3 seater sofa cm. 276, with right arm and left angle.
 F Canapé 3 places cm. 276, avec accoudoir droit et angle gauche.
 D Sofa 3-sitzig cm. 276, mit rechter Armlehne und Winkel links.
 S Sofá de 3 plazas 276, con brazo derecho y rincón izquierdo.

cm. 276 x 102 x h 61.5 – hs 40 • mt. 11.70
 in. 108³/₈ x 40¹/₈ x h 24³/₄ – hs 15³/₈ • yd. 12.80

COM	3.642,00
L	3.885,00
T	4.177,00
S	4.420,00
Z	4.711,00
K	4.954,00
PS	6.158,00
PF	7.035,00
PX	8.438,00
PA	9.753,00

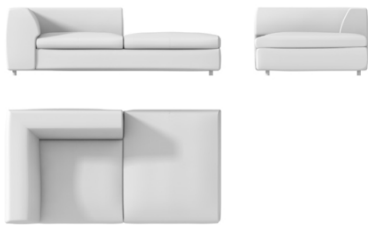

GLACE0CHAISDX

I Chaiselongue destra.
 E Right chaiselongue.
 F Dormeuse droite.
 D Rechte Dormeuse.
 S Chaise longue derecha.

cm. 102 x 195 x h 61.5 – hs 40 • mt. 7.80
 in. 40¹/₈ x 76³/₈ x h 24³/₄ – hs 15³/₈ • yd. 8.55

COM	2.725,00
L	2.886,00
T	3.080,00
S	3.241,00
Z	3.435,00
K	3.596,00
PS	4.425,00
PF	5.006,00
PX	5.937,00
PA	6.808,00



GLACE0CHAIS SX

I Chaiselongue sinistra.
 E Left chaiselongue.
 F Dormeuse gauche.
 D Linke Dormeuse.
 S Chaise longue izquierda.

cm. 102 x 195 x h 61.5 – hs 40 • mt. 7.80
 in. 40¹/₈ x 76³/₈ x h 24³/₄ – hs 15³/₈ • yd. 8.55

COM	2.725,00
L	2.886,00
T	3.080,00
S	3.241,00
Z	3.435,00
K	3.596,00
PS	4.425,00
PF	5.006,00
PX	5.937,00
PA	6.808,00



GLACE0PENISDX

I Penisola lineare destra.
 E Right linear chaiselongue.
 F Dormeuse linéaire droite.
 D Rechte lineare Dormeuse.
 S Chaise longue lineal derecha

cm. 102 x 195 x h 61.5 – hs 40 • mt. 7.15
 in. 40¹/₈ x 76³/₈ x h 24³/₄ – hs 15³/₈ • yd. 7.80

COM	2.265,00
L	2.413,00
T	2.590,00
S	2.738,00
Z	2.915,00
K	3.062,00
PS	3.841,00
PF	4.372,00
PX	5.222,00
PA	6.019,00









GLACE0PENIS SX

I Penisola lineare sinistra.
 E Left linear chaiselongue.
 F Dormeuse linéaire gauche.
 D Linke lineare Dormeuse.
 S Chaise longue lineal izquierda

cm. 102 x 195 x h 61.5 – hs 40 • mt. 7.15
 in. 40¹/₈ x 76³/₈ x h 24³/₄ – hs 15³/₈ • yd. 7.80

COM	2.265,00
L	2.413,00
T	2.590,00
S	2.738,00
Z	2.915,00
K	3.062,00
PS	3.841,00
PF	4.372,00
PX	5.222,00
PA	6.019,00

GLACE' - Design Mauro Lipparini

	<p>GLACE0POUFQUA</p> <p>I Pouf cm. 100X100. E Ottoman cm. 100X100. F Pouf cm. 100X100. D Hocker cm. 100X100. S Pouf cm. 100X100.</p>	<p>COM 1.028,00 L 1.085,00 T 1.153,00 S 1.209,00 Z 1.277,00 K 1.334,00 PS 1.655,00 PF 1.860,00 PX 2.187,00 PA 2.494,00</p>
	<p>cm. 100 x 100 x h 40 – hs 40 • mt. 2.75 in. 39”½ x 39”½ x h 15”½ – hs 15”½ • yd. 3.00</p>	
	<p>GLACE0SCHIE67</p> <p>I Cuscino cm. 67x47. E Cushion cm. 67x47. F Coussin cm. 67x47. D Kissen cm. 67x47. S Cojín cm. 67x47.</p>	<p>COM 210,00 L 229,00 T 250,00 S 268,00 Z 290,00 K 308,00 PS 394,00 PF 462,00 PX 572,00 PA 674,00</p>
	<p>cm. 67 x 47 x h 20 • mt. 0.90 in. 26”½ x 18”½ x h 7”½ • yd. 1.00</p>	
	<p>GLACE0SCHIE75</p> <p>I Cuscino cm. 75x47. E Cushion cm. 75x47. F Coussin cm. 75x47. D Kissen cm. 75x47. S Cojín cm. 75x47.</p>	<p>COM 221,00 L 241,00 T 264,00 S 283,00 Z 307,00 K 325,00 PS 421,00 PF 493,00 PX 610,00 PA 719,00</p>
	<p>cm. 75 x 47 x h 20 • mt. 0.95 in. 29”½ x 18”½ x h 7”½ • yd. 1.05</p>	
	<p>GLACE0SCHIE82</p> <p>I Cuscino cm. 82x47. E Cushion cm. 82x47. F Coussin cm. 82x47. D Kissen cm. 82x47. S Cojín cm. 82x47.</p>	<p>COM 226,00 L 247,00 T 273,00 S 295,00 Z 320,00 K 342,00 PS 431,00 PF 508,00 PX 631,00 PA 747,00</p>
	<p>cm. 82 x 47 x h 20 • mt. 1.05 in. 32”¼ x 18”½ x h 7”½ • yd. 1.15</p>	
	<p>GLACE0SCHIE97</p> <p>I Cuscino cm. 97x47. E Cushion cm. 97x47. F Coussin cm. 97x47. D Kissen cm. 97x47. S Cojín cm. 97x47.</p>	<p>COM 242,00 L 267,00 T 297,00 S 322,00 Z 352,00 K 377,00 PS 500,00 PF 594,00 PX 748,00 PA 890,00</p>
	<p>cm. 97 x 47 x h 20 • mt. 1.20 in. 38”¼ x 18”½ x h 7”½ • yd. 1.30</p>	
	<p>GLACE0SCHFASC</p> <p>I Cuscinetto con fascia cm. 50x50. E Cushion with band cm. 50x50. F Coussin à plate-bande cm. 50x50. D Kissen mit Band cm. 50x50. S Cojín con banda cm. 50x50.</p>	<p>COM 191,00 L 205,00 T 222,00 S 238,00 Z 255,00 K 270,00 PS 352,00 PF 402,00 PX 482,00 PA 556,00</p>
	<p>cm. 50 x 50 x h 13 • mt. 0.75 in. 19”½ x 19”½ x h 5”½ • yd. 0.85</p>	

GLACE' - Design Mauro Lipparini



GLACE0SCHSAPO

- I Cuscinetto a saponetta cm. 50x50.
- E Cushion knife edge cm. 50x50.
- F Coussin ovale cm. 50x50.
- D Seife Kissen cm. 50x50.
- S Cojín tipo "jabón" cm. 50x50.

cm. 50 x 50 x h 10 • mt. 0.65
 in. 19" x 19" x h 3" • yd. 0.70

COM	187,00
L	201,00
T	217,00
S	231,00
Z	247,00
K	261,00
PS	337,00
PF	383,00
PX	455,00
PA	523,00

HOLLY - Design Umberto Asnago



Struttura. Lo schienale è in multistrato di faggio curvato in stampo. Il sedile è in legno massello di pioppo (stagionato "naturalmente" per almeno 3 anni); giunzioni a incastro con spine cilindriche. Il molleggio è garantito da cinghie elastiche in polipropilene e lattice naturale. L'imbottitura della struttura è ottenuta con lastre di poliuretano espanso indeformabile a densità differenziate (30÷35 kg/m³) esente da CFC ricoperto da ovatta poliestere e vellutino accoppiato.

Base. Piedini in legno massello di pioppo rivestiti in cuoio

Rivestimento. Disponibile in tessuto e pelle anche in versione combinata; sfoderabile solo nella versione in tessuto.

Frame. The backrest is in beech plywood curved into a mould. The seat is in solid poplar heartwood ("naturally" seasoned for at least 3 years); dap joints with cylindrical dowels. The webbing is secured by elastic polypropylene and natural latex belts. The framework is upholstered with contoured sheets of resilient, CFC-free polyurethane foam (with density of 30÷35 kg/m³) covered by polyester wadding and bonded plush.

Base. Supports in solid poplar heartwood covered in saddle leather.

Covers. Available in fabric or leather also with a mixed version; removable covers only for fabric version.



HOLLYPOLTRON

I Poltrona.

E Armchair.

F Fauteuil.

D Sessel.

S Butaca.

cm. 78 x 85 x h 71 – hs 44 • mt. 4.05
in. 30³/₄ x 33¹/₂ x h 28" – hs 17³/₈ • yd. 4.45

COM	1.995,00
L	2.071,00
T	2.162,00
S	2.238,00
Z	2.330,00
K	2.405,00
PS	2.760,00
PF	3.036,00
PX	3.476,00
PA	3.889,00

INSULA - Design Luca Scacchetti



Struttura. Il sedile è in legno massello di pioppo (stagionato "naturalmente" per almeno 3 anni) con elementi in multistrato di pioppo; giunzioni a incastro con spine cilindriche. Il molleggio è garantito da cinghie elastiche in polipropilene e lattice naturale. Lo schienale e i braccioli sono in pannello nobilitato con elementi di acciaio per il fissaggio al sedile. L'imbottitura del sedile è ottenuta con lastre di poliuretano espanso indeformabile con densità di 30 kg/m³ ed esente da CFC, rivestito con un materassino di ovatta poliesteri cucita assieme al rivestimento finale in tessuto o pelle. La parte esterna rivestita in cuoio. Lo schienale e i braccioli sono imbottiti con lastre di poliuretano espanso indeformabile con densità di 40 kg/m³ ed esente da CFC ricoperto da ovatta poliesteri.

Cuscini. Cuscini di schienale in piuma canalizzata con bordo a palloncino.

Base. Base in acciaio disponibile in finitura cromata o verniciata a polveri epossidiche in colore RAL a scelta.

Rivestimento. Disponibile in tessuto e pelle; sfoderabile solo per i cuscini.

Frame. The seat is in solid poplar heartwood ("naturally" seasoned for at least 3 years) with connecting elements in poplar plywood; dap joints with cylindrical dowels. The webbing is secured by elastic polypropylene and natural latex belts. The backrest and the armrests are in melamine coated panels with tubular steel elements fixed to the seat. The seat is upholstered with contoured sheets of resilient, CFC-free polyurethane foam with density of 30 kg/m³ covered by polyester wadding mat sewed to the final cover in fabric or leather. The lower part is covered in saddle leather. The backrest and armrests are upholstered with contoured sheets of resilient, CFC-free polyurethane foam with density of 40 kg/m³ covered by polyester wadding.

Cushions. The back cushions are feather-filled and with piping.

Base. Base in steel available chromed or epoxy powder painted in RAL colors of your choice.

Covers. Available in fabric or leather; removable covers only for cushions.

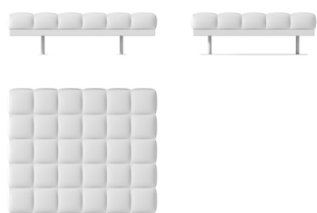

INSULAP132110

I Elemento di seduta cm. 132x110.

E Seating element cm. 132x110.

F Élément d'assise cm. 132x110.

D Sitting Element cm. 132x110.

S Elemento de asiento cm. 132x110.

cm. 132 x 110 x h 38 – hs 38 • mt. 3.50
in. 52" x 43"¼ x h 15" – hs 15" • yd. 3.85

COM	2.066,00
L	2.139,00
T	2.226,00
S	2.299,00
Z	2.387,00
K	2.459,00
PS	2.473,00
PF	2.650,00
PX	2.933,00
PA	3.199,00

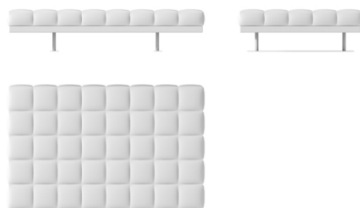

INSULAP176110

I Elemento di seduta cm. 176x110.

E Seating element cm. 176x110.

F Élément d'assise cm. 176x110.

D Sitting Element cm. 176x110.

S Elemento de asiento cm. 176x110.

cm. 176 x 110 x h 38 – hs 38 • mt. 3.50
in. 69"¼ x 43"¼ x h 15" – hs 15" • yd. 3.85

COM	2.371,00
L	2.443,00
T	2.531,00
S	2.603,00
Z	2.690,00
K	2.763,00
PS	3.005,00
PF	3.251,00
PX	3.643,00
PA	4.011,00

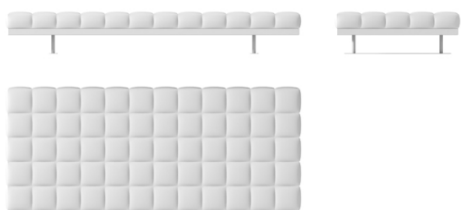

INSULAP264110

I Elemento di seduta cm. 264x110.

E Seating element cm. 264x110.

F Élément d'assise cm. 264x110.





D Sitting Element cm. 264x110.

S Elemento de asiento cm. 264x110.

cm. 264 x 110 x h 38 – hs 38 • mt. 4.95
in. 103"¼ x 43"¼ x h 15" – hs 15" • yd. 5.40

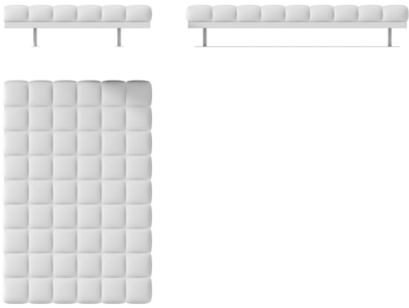
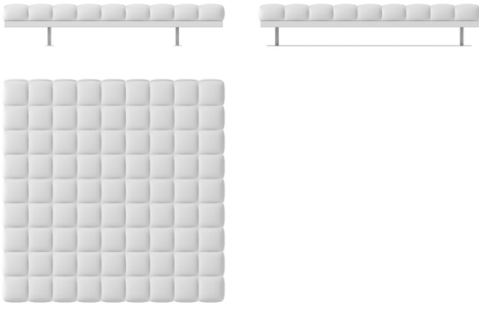
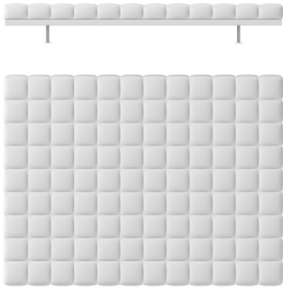
COM	3.074,00
L	3.175,00
T	3.298,00
S	3.401,00
Z	3.524,00
K	3.626,00
PS	3.963,00
PF	4.479,00
PX	4.854,00
PA	5.369,00

INSULA - Design Luca Scacchetti

	<p>INSULAP132198</p> <p>I Elemento di seduta cm. 132x198. E Seating element cm. 132x198. F Élément d'assise cm. 132x198. D Sitting Element cm. 132x198. S Elemento de asiento cm. 132x198.</p>	<p>COM 2.780,00 L 2.862,00 T 2.960,00 S 3.042,00 Z 3.139,00 K 3.222,00 PS 3.507,00 PF 3.788,00 PX 4.239,00 PA 4.662,00</p>
<p>cm. 132 x 198 x h 38 – hs 38 • mt. 3.95 in. 52" x 78" x h 15" – hs 15" • yd. 4.30</p>		
	<p>INSULAP198198</p> <p>I Elemento di seduta cm. 198x198. E Seating element cm. 198x198. F Élément d'assise cm. 198x198. D Sitting Element cm. 198x198. S Elemento de asiento cm. 198x198.</p>	<p>COM 3.999,00 L 4.113,00 T 4.249,00 S 4.362,00 Z 4.499,00 K 4.612,00 PS 5.072,00 PF 5.469,00 PX 6.105,00 PA 6.701,00</p>
<p>cm. 198 x 198 x h 38 – hs 38 • mt. 5.50 in. 78" x 78" x h 15" – hs 15" • yd. 6.00</p>		
	<p>INSULAP264198</p> <p>I Elemento di seduta cm. 264x198. E Seating element cm. 264x198. F Élément d'assise cm. 264x198. D Sitting Element cm. 264x198. S Elemento de asiento cm. 264x198.</p>	<p>COM 4.929,00 L 5.074,00 T 5.248,00 S 5.393,00 Z 5.568,00 K 5.713,00 PS 6.343,00 PF 6.861,00 PX 7.689,00 PA 8.466,00</p>
<p>cm. 264 x 198 x h 38 – hs 38 • mt. 7.05 in. 103" x 78" x h 15" – hs 15" • yd. 7.70</p>		
	<p>INSULASCHI088</p> <p>I Schienale cm. 88. E Backrest cm. 88. F Dossier cm. 88. D Rückenlehne cm. 88. S Respaldo cm. 88.</p>	<p>COM 491,00 L 512,00 T 537,00 S 557,00 Z 582,00 K 602,00 PS 677,00 PF 741,00 PX 843,00 PA 937,00</p>
<p>cm. 88 x 22 x h 32 • mt. 1.00 in. 34" x 8" x h 12" • yd. 1.10</p>		
	<p>INSULASCHI132</p> <p>I Schienale cm. 132. E Backrest cm. 132. F Dossier cm. 132. D Rückenlehne cm. 132. S Respaldo cm. 132.</p>	<p>COM 619,00 L 650,00 T 687,00 S 717,00 Z 754,00 K 785,00 PS 871,00 PF 966,00 PX 1.119,00 PA 1.262,00</p>
<p>cm. 132 x 22 x h 32 • mt. 1.50 in. 52" x 8" x h 12" • yd. 1.65</p>		
	<p>INSULASCHI176</p> <p>I Schienale cm. 176. E Backrest cm. 176. F Dossier cm. 176. D Rückenlehne cm. 176. S Respaldo cm. 176.</p>	<p>COM 731,00 L 773,00 T 822,00 S 862,00 Z 912,00 K 953,00 PS 1.077,00 PF 1.204,00 PX 1.408,00 PA 1.599,00</p>
<p>cm. 176 x 22 x h 32 • mt. 2.00 in. 69" x 8" x h 12" • yd. 2.20</p>		

INSULA - Design Luca Scacchetti

	INSULASCHI198	<p>I Schienale cm. 198. E Backrest cm. 198. F Dossier cm. 198. D Rückenlehne cm. 198. S Respaldo cm. 198.</p>	COM	825,00		
			L	871,00		
			T	925,00		
			S	971,00		
			Z	1.025,00		
			K	1.071,00		
			PS	1.221,00		
			PF	1.366,00		
			PX	1.599,00		
			PA	1.817,00		
			cm. 198 x 22 x h 32 • mt. 2.20			
			in. 78" x 8 7/8" x h 12 1/4" • yd. 2.40			
	INSULASCHI264	<p>I Schienale cm. 264. E Backrest cm. 264. F Dossier cm. 264. D Rückenlehne cm. 264. S Respaldo cm. 264.</p>	COM	996,00		
			L	1.060,00		
			T	1.136,00		
			S	1.200,00		
			Z	1.276,00		
			K	1.340,00		
			PS	1.522,00		
			PF	1.718,00		
			PX	2.030,00		
			PA	2.324,00		
			cm. 264 x 22 x h 32 • mt. 3.10			
			in. 103 3/4" x 8 7/8" x h 12 1/4" • yd. 3.40			
	INSULACUSC050	<p>I Cuscino cm. 50x47. E Pillow cm. 50x47. F Coussin cm. 50x47. D Kissen cm. 50x47. S Cojín cm. 50x47.</p>	COM	215,00		
			L	229,00		
			T	245,00		
			S	259,00		
			Z	275,00		
			K	288,00		
			PS	351,00		
			PF	397,00		
			PX	469,00		
			PA	538,00		
			cm. 50 x 47 x h 10 • mt. 0.70			
			in. 19 1/2" x 18 1/2" x h 3 3/8" • yd. 0.75			
	INSULACUSC067	<p>I Cuscino cm. 67x47. E Pillow cm. 67x47. F Coussin cm. 67x47. D Kissen cm. 67x47. S Cojín cm. 67x47.</p>	COM	269,00		
			L	289,00		
			T	314,00		
			S	335,00		
			Z	358,00		
			K	379,00		
			PS	440,00		
			PF	499,00		
			PX	571,00		
			PA	659,00		
			cm. 67 x 47 x h 10 • mt. 0.85			
			in. 26 3/8" x 18 1/2" x h 3 3/8" • yd. 0.95			
	INSULACUSC081	<p>I Cuscino cm. 81x47. E Pillow cm. 81x47. F Coussin cm. 81x47. D Kissen cm. 81x47. S Cojín cm. 81x47.</p>	COM	301,00		
			L	325,00		
			T	355,00		
			S	380,00		
			Z	410,00		
			K	435,00		
			PS	497,00		
			PF	565,00		
			PX	675,00		
			PA	777,00		
			cm. 81 x 47 x h 10 • mt. 1.00			
			in. 31 3/8" x 18 1/2" x h 3 3/8" • yd. 1.10			
	INSULACUSC097	<p>I Cuscino cm. 97x47. E Pillow cm. 97x47. F Coussin cm. 97x47. D Kissen cm. 97x47. S Cojín cm. 97x47.</p>	COM	320,00		
			L	347,00		
			T	380,00		
			S	407,00		
			Z	440,00		
			K	468,00		
			PS	541,00		
			PF	618,00		
			PX	742,00		
			PA	857,00		
			cm. 97 x 47 x h 10 • mt. 1.20			
			in. 38 1/4" x 18 1/2" x h 3 3/8" • yd. 1.30			

INSULASUPPSEDCR

I Supplemento per basamento cromato per ogni singolo elemento imbottito.	
E Extra charge for chromed base for every single upholstered item.	
F Supplément pour piétement chromé pour chaque single élément rembourré.	294,00
D Mehrpreis fuer verchromtem Gestell fuer jede gepolstert Element.	
S Suplemento para la base cromada de cada elemento tapizado.	

JOSHUA - Design Umberto Asnago



Struttura. In legno massello di pioppo e faggio (stagionato "naturalmente" per almeno 3 anni) con elementi in multistrato di pioppo; giunzioni a incastro con spine cilindriche. Il molleggio è garantito da cinghie elastiche in polipropilene e lattice naturale. L'imbottitura della struttura è ottenuta con lastre di poliuretano espanso indeformabile a densità differenziate (30÷35 kg/m³) esente da CFC ricoperto da ovatta poliestere e vellutino accoppiato. I braccioli sono in tubolare d'acciaio annegato in poliuretano espanso, schiumato a freddo in stampo e rivestite con vellutino accoppiato.

Cuscini. Cuscini di seduta divisi in 3 camere orizzontali: le due esterne sono in piuma canalizzata mentre nella centrale c'è una lastra di poliuretano (40 kg/m³). I cuscini di schienale sono completamente in piuma canalizzata.

Base. Piedini in piatto d'acciaio curvato disponibili in finitura cromata o verniciata a polveri epossidiche in colore RAL a scelta.

Rivestimento. Disponibile in tessuto e pelle anche in versione combinata; sfoderabile solo nella versione in tessuto.

Frame. In solid poplar or beech heartwood ("naturally" seasoned for at least 3 years) with connecting elements in poplar plywood; dap joints with cylindrical dowels. The webbing is secured by elastic polypropylene and natural latex belts. The framework is upholstered with contoured sheets of resilient, CFC-free polyurethane foam (with density of 30÷35 kg/m³) covered by polyester wadding and bonded plush. The armrests have a tubular steel frame embedded in cold formed polyurethane foam made in mould and covered by bonded plush.

Cushions. The seat cushions are subdivided in 3 horizontal units: the two outside units are feather filled while in the central one there is a sheet of polyurethane foam (40 kg/m³). The back cushions are feather-filled.

Base. Supports in steel sheet curved available chromed or epoxy powder painted in RAL colors of your choice.

Covers. Available in fabric or leather also in a mixed version; removable covers only for fabric version.



JOSHUAPOLT090

I Poltrona.
E Armchair.
F Fauteuil.
D Sessel.
S Butaca.

cm. 90 x 96 x h 83 – hs 42 • mt. 5.85
in. 35³/₈ x 37³/₈ x h 32³/₈ – hs 16³/₈ • yd. 6.40

COM	2.718,00
L	2.844,00
T	2.995,00
S	3.122,00
Z	3.273,00
K	3.399,00
PS	3.824,00
PF	4.262,00
PX	4.963,00
PA	5.620,00



JOSHUADIVA180

I Divano 2 posti.
E 2 seater sofa.
F Canapé 2 places.
D Sofa 2-sitzig.
S Sofá de 2 plazas.

cm. 180 x 96 x h 83 – hs 42 • mt. 9.90
in. 70³/₈ x 37³/₈ x h 32³/₈ – hs 16³/₈ • yd. 10.85

COM	3.741,00
L	3.955,00
T	4.212,00
S	4.426,00
Z	4.683,00
K	4.898,00
PS	5.437,00
PF	6.127,00
PX	7.232,00
PA	8.266,00



JOSHUADIVA210

I Divano 3 posti cm. 210.
E 3 seater sofa cm. 210.
F Canapé 3 places cm. 210.
D Sofa 3-sitzig cm. 210.
S Sofá de 3 plazas cm. 210.

cm. 210 x 96 x h 83 – hs 42 • mt. 10.90
in. 82³/₈ x 37³/₈ x h 32³/₈ – hs 16³/₈ • yd. 11.90

COM	4.004,00
L	4.239,00
T	4.522,00
S	4.758,00
Z	5.040,00
K	5.276,00
PS	5.880,00
PF	6.641,00
PX	7.860,00
PA	8.960,00

JOSHUA - Design Umberto Asnago



JOSHUA DIVA 240

I Divano 3 posti cm. 240.
 E 3 seater sofa cm. 240.
 F Canapé 3 places cm. 240.
 D Sofa 3-sitzig cm. 240.
 S Sofá de 3 plazas cm. 240.

cm. 240 x 96 x h 83 – hs 42 • mt. 12.65
 in. 94”½ x 37”¾ x h 32”¾ – hs 16”½ • yd. 13.85

COM	4.370,00
L	4.644,00
T	4.973,00
S	5.246,00
Z	5.574,00
K	5.848,00
PS	6.520,00
PF	7.395,00
PX	8.796,00
PA	10.109,00



JOSHUA DIVA 270

I Divano 4 posti.
 E 4 seater sofa.
 F Canapé 4 places.
 D Sofa 4-sitzig.
 S Sofá de 4 plazas.

cm. 270 x 96 x h 83 – hs 42 • mt. 13.75
 in. 106”¼ x 37”¾ x h 32”¾ – hs 16”½ • yd. 15.05

COM	4.878,00
L	5.176,00
T	5.533,00
S	5.830,00
Z	6.187,00
K	6.485,00
PS	7.368,00
PF	8.367,00
PX	9.965,00
PA	11.465,00

JOSHUA - Design Umberto Asnago



Tavolini. La struttura è in piatto d'acciaio curvato disponibile in finitura cromata o verniciata a polveri epossidiche in colore RAL a scelta. Il piano è disponibile in 3 finiture: a) in cristallo color bronzo retro verniciato colore alluminio; b) in marmo; c) in pannello nobilitato rivestito in cuoio.

Low tables. Frame in steel sheet curved available chromed or epoxy powder painted in RAL colors of your choice. Top available in 3 different finished: a) bronzed glass aluminum color painted underneath; b) marble; c) in melamine coated panel covered in saddle leather.

I Tavolino cm. 141x66 con base cromata nera. Disponibile in: cristallo bronzo temperato e verniciato alluminio (CR); cuoio (CU); marmo Calacatta Oro (MC); marmo Forest Brown, Marquina Nero, Marron Emperador o Bianco Carrara Gioia (MM).

E Coffee table cm. 141x66 with black chromed base. Available in: bronzed tempered glass aluminium varnished (CR); saddle leather (CU); Calacatta Oro marble (MC); Forest Brown, Black Marquina, Marron Emperador or White Carrara Gioia marble (MM).

F Table basse cm. 141x66 avec base chromé noire. Disponible en: cristal bronzé trempé et verni couleur aluminium (CR); cuir (CU); marbre Calacatta Oro (MC); marbre Forest Brown, Black Marquina, Marron Emperador ou blanc Carrara Gioia (MM).

D Tisch cm. 141x66 mit schwarz verchromtem Fuss. Lieferbar mit: bronziert gehärtetem Glas und Aluminium lackiert (CR); Rindleder (CU); Calacatta Oro Marmor (MC); Marmor Forest Brown, Black Marquina, Marron Emperador oder Marmor Carrara Gioia (MM).

S Mesa centro cm. 141x66 con base cromada negra. Disponible en: cristal templado bronceado y pintado color aluminio (CR); cuero (CU); mármol Calacatta Oro (MC); mármol Forest Brown, Black Marquina, Marron Emperador o bien mármol Carrara Gioia (MM).

cm. 141 x 66 x h 30
 in. 55”½ x 26” x h 11”¾

JOSHUATA140CR

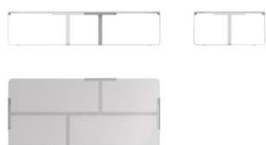

2.873,00

JOSHUATA140CU



CV 2.759,00
 CF 2.604,00
 CS 2.410,00

JOSHUATA140MC



3.387,00

JOSHUATA140MM







2.954,00

JOSHUA - Design Umberto Asnago



I Tavolino cm. 101x101 con base cromata nera. Disponibile in: cristallo bronzo temperato e verniciato alluminio (CR); cuoio (CU); marmo Calacatta Oro (MC); marmo Forest Brown, Marquina Nero, Marron Emperador o Bianco Carrara Gioia (MM).
 E Coffee table cm. 101x101 with black chromed base. Available in: bronzed tempered glass aluminium varnished (CR); saddle leather (CU); Calacatta Oro marble (MC); Forest Brown, Black Marquina, Marron Emperador or White Carrara Gioia marble (MM).
 F Table basse cm. 101x101 avec base chromé noire. Disponible en: cristal bronzé trempé et verni couleur aluminium (CR); cuir (CU); marbre Calacatta Oro (MC); marbre Forest Brown, Black Marquina, Marron Emperador ou blanc Carrara Gioia (MM).
 D Tisch cm. 101x101 mit schwarz verchromtem Fuss.Lieferbar mit: bronziert gehärtetem Glas und Aluminium lackiert (CR); Rindleder (CU); Calacatta Oro Marmor (MC); Marmor Forest Brown, Black Marquina, Marron Emperador oder Marmor Carrara Gioia (MM).
 S Mesa centro cm. 101x101 con base cromada negra. Disponible en: cristal templado bronceado y pintado color aluminio (CR); cuero (CU); mármol Calacatta Oro (MC); mármol Forest Brown, Black Marquina, Marron Emperador o bien mármol Carrara Gioia (MM).

cm. 101 x 101 x h 30
 in. 39³/₄ x 39³/₄ x h 11³/₄

JOSHUATA100CR	JOSHUATA100CU	JOSHUATA100MC	JOSHUATA100MM
			
2.817,00	CV 2.715,00 CF 2.550,00 CS 2.344,00	3.426,00	2.964,00



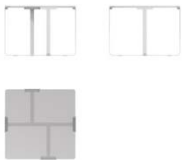

I Tavolino cm. 66x66 con base cromata nera. Disponibile in: cristallo bronzo temperato e verniciato alluminio (CR); cuoio (CU); marmo Calacatta Oro (MC); marmo Forest Brown, Marquina Nero, Marron Emperador o Bianco Carrara Gioia (MM).
 E Coffee table cm. 66x66 with black chromed base. Available in: bronzed tempered glass aluminium varnished (CR); saddle leather (CU); Calacatta Oro marble (MC); Forest Brown, Black Marquina, Marron Emperador or White Carrara Gioia marble (MM).
 F Table basse cm. 66x66 avec base chromé noire. Disponible en: cristal bronzé trempé et verni couleur aluminium (CR); cuir (CU); marbre Calacatta Oro (MC); marbre Forest Brown, Black Marquina, Marron Emperador ou blanc Carrara Gioia (MM).
 D Tisch cm. 66x66 mit schwarz verchromtem Fuss.Lieferbar mit: bronziert gehärtetem Glas und Aluminium lackiert (CR); Rindleder (CU); Calacatta Oro Marmor (MC); Marmor Forest Brown, Black Marquina, Marron Emperador oder Marmor Carrara Gioia (MM).
 S Mesa centro cm. 66x66 con base cromada negra. Disponible en: cristal templado bronceado y pintado color aluminio (CR); cuero (CU); mármol Calacatta Oro (MC); mármol Forest Brown, Black Marquina, Marron Emperador o bien mármol Carrara Gioia (MM).

cm. 66 x 66 x h 45
 in. 26" x 26" x h 17³/₄

JOSHUATA065CR	JOSHUATA065CU	JOSHUATA065MC	JOSHUATA065MM
			
1.828,00	CV 1.925,00 CF 1.844,00 CS 1.744,00	2.122,00	1.870,00

I Tavolino cm. 41x41 con base cromata nera. Disponibile in: cristallo bronzo temperato e verniciato alluminio (CR); cuoio (CU); marmo Calacatta Oro (MC); marmo Forest Brown, Marquina Nero, Marron Emperador o Bianco Carrara Gioia (MM).
 E Coffee table cm. 41x41 with black chromed base. Available in: bronzed tempered glass aluminium varnished (CR); saddle leather (CU); Calacatta Oro marble (MC); Forest Brown, Black Marquina, Marron Emperador or White Carrara Gioia marble (MM).
 F Table basse cm. 41x41 avec base chromé noire. Disponible en: cristal bronzé trempé et verni couleur aluminium (CR); cuir (CU); marbre Calacatta Oro (MC); marbre Forest Brown, Black Marquina, Marron Emperador ou blanc Carrara Gioia (MM).
 D Tisch cm. 41x41 mit schwarz verchromtem Fuss.Lieferbar mit: bronziert gehärtetem Glas und Aluminium lackiert (CR); Rindleder (CU); Calacatta Oro Marmor (MC); Marmor Forest Brown, Black Marquina, Marron Emperador oder Marmor Carrara Gioia (MM).
 S Mesa centro cm. 41x41 con base cromada negra. Disponible en: cristal templado bronceado y pintado color aluminio (CR); cuero (CU); mármol Calacatta Oro (MC); mármol Forest Brown, Black Marquina, Marron Emperador o bien mármol Carrara Gioia (MM).

cm. 41 x 41 x h 55
 in. 16¹/₂ x 16¹/₂ x h 21¹/₂

JOSHUATA040CR	JOSHUATA040CU	JOSHUATA040MC	JOSHUATA040MM
			
1.513,00	CV 1.533,00 CF 1.495,00 CS 1.448,00	1.500,00	1.387,00

KATE - Design Matteo Nunziati



Struttura. In legno massello di pioppo e faggio (stagionato "naturalmente" per almeno 3 anni) con elementi in multistrato di pioppo; giunzioni a incastro con spine cilindriche. Il molleggio è garantito da cinghie elastiche in polipropilene e lattice naturale. L'imbottitura della struttura è ottenuta con lastre di poliuretano espanso indeformabile a densità differenziate (35÷70 kg/m³) esente da CFC ricoperto da ovatta poliestere e vellutino accoppiato.

Cuscini. Cuscini di schienale in piuma canalizzata.

Base. Supporti in acciaio cromato.

Rivestimento. Disponibile in tessuto e pelle; sfoderabile solo nella versione in tessuto.

Frame. In solid poplar or beech heartwood ("naturally" seasoned for at least 3 years) with connecting elements in poplar plywood; dap joints with cylindrical dowels. The webbing is secured by elastic polypropylene and natural latex belts. The framework is upholstered with contoured sheets of resilient, CFC-free polyurethane foam (with density of 35÷70 kg/m³) covered by polyester wadding and bonded plush.

Cushions. The back cushions are feather-filled.

Base. Supports in chromed steel.

Covers. Available in fabric or leather; removable covers only for fabric version.

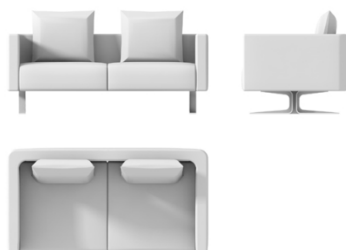

KATE00DIVA180

I Divano 2 posti.
E 2 seater sofa.
F Canapé 2 places.
D Sofa 2-sitzig.
S Sofá de 2 plazas.

cm. 180 x 93 x h 72 – hs 45 • mt. 8.80
in. 70 7/8" x 36 3/8" x h 28 3/8" – hs 17 3/4" • yd. 9.65

COM	3.383,00
L	3.565,00
T	3.782,00
S	3.964,00
Z	4.182,00
K	4.364,00
PS	5.275,00
PF	5.929,00
PX	6.975,00
PA	7.956,00



KATE00DI170DX

I Divano 2 posti con bracciolo destro.
E 2 seater sofa with right arm.
F Canapé 2 places avec accoudoir droit.
D Sofa 2-sitzig mit rechter Armlehne.
S Sofá de 2 plazas con brazo derecho.

cm. 170 x 93 x h 72 – hs 45 • mt. 7.10
in. 66 7/8" x 36 3/8" x h 28 3/8" – hs 17 3/4" • yd. 7.75

COM	3.182,00
L	3.327,00
T	3.501,00
S	3.647,00
Z	3.821,00
K	3.967,00
PS	4.713,00
PF	5.231,00
PX	6.059,00
PA	6.836,00

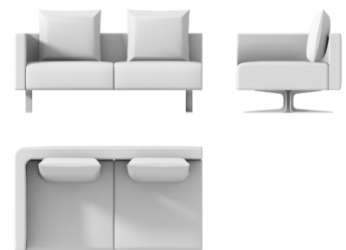

KATE00DI170SX

I Divano 2 posti con bracciolo sinistro.
E 2 seater sofa with left arm.
F Canapé 2 places avec accoudoir gauche.
D Sofa 2-sitzig mit linker Armlehne.
S Sofá de 2 plazas con brazo izquierdo.

cm. 170 x 93 x h 72 – hs 45 • mt. 7.10
in. 66 7/8" x 36 3/8" x h 28 3/8" – hs 17 3/4" • yd. 7.75

COM	3.182,00
L	3.327,00
T	3.501,00
S	3.647,00
Z	3.821,00
K	3.967,00
PS	4.713,00
PF	5.231,00
PX	6.059,00
PA	6.836,00







KATE00DIVA210

I Divano 3 posti cm. 210.
E 3 seater sofa cm. 210.
F Canapé 3 places cm. 210.
D Sofa 3-sitzig cm. 210.
S Sofá de 3 plazas cm. 210.

cm. 210 x 93 x h 72 – hs 45 • mt. 9.90
in. 82 7/8" x 36 3/8" x h 28 3/8" – hs 17 3/4" • yd. 10.85

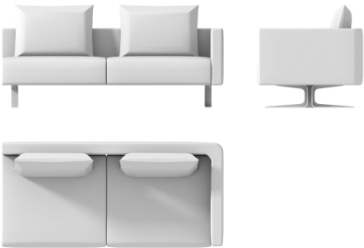
COM	3.679,00
L	3.884,00
T	4.129,00
S	4.333,00
Z	4.579,00
K	4.783,00
PS	5.792,00
PF	6.528,00
PX	7.705,00
PA	8.809,00

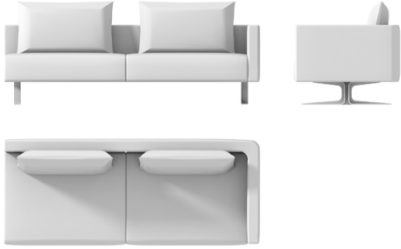
KATE - Design Matteo Nunziati

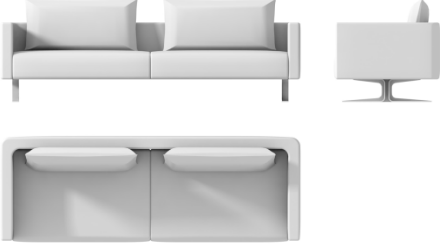
	<p>KATE00DI200DX</p> <p>I Divano 3 posti con bracciolo destro. E 3 seater sofa with right arm. F Canapé 3 places avec accoudoir droit. D Sofa 3-sitzig mit rechter Armlehne. S Sofá de 3 plazas con brazo derecho.</p>	<p>COM 3.393,00 L 3.561,00 T 3.763,00 S 3.930,00 Z 4.132,00 K 4.300,00 PS 5.146,00 PF 5.745,00 PX 6.704,00 PA 7.603,00</p>
	<p>KATE00DI200SX</p> <p>I Divano 3 posti con bracciolo sinistro. E 3 seater sofa with left arm. F Canapé 3 places avec accoudoir gauche. D Sofa 3-sitzig mit linker Armlehne. S Sofá de 3 plazas con brazo izquierdo.</p>	<p>COM 3.393,00 L 3.561,00 T 3.763,00 S 3.930,00 Z 4.132,00 K 4.300,00 PS 5.146,00 PF 5.745,00 PX 6.704,00 PA 7.603,00</p>
	<p>KATE00DIVA240</p> <p>I Divano 3 posti cm. 240. E 3 seater sofa cm. 240. F Canapé 3 places cm. 240. D Sofa 3-sitzig cm. 240. S Sofá de 3 plazas cm. 240.</p>	<p>COM 3.842,00 L 4.070,00 T 4.341,00 S 4.569,00 Z 4.841,00 K 5.069,00 PS 6.170,00 PF 6.988,00 PX 8.296,00 PA 9.522,00</p>
	<p>KATE00DI230DX</p> <p>I Divano 3 posti con bracciolo destro. E 3 seater sofa with right arm. F Canapé 3 places avec accoudoir droit. D Sofa 3-sitzig mit rechter Armlehne. S Sofá de 3 plazas con brazo derecho.</p>	<p>COM 3.638,00 L 3.829,00 T 4.057,00 S 4.248,00 Z 4.477,00 K 4.668,00 PS 5.605,00 PF 6.287,00 PX 7.377,00 PA 8.400,00</p>
	<p>KATE00DI230SX</p> <p>I Divano 3 posti con bracciolo sinistro. E 3 seater sofa with left arm. F Canapé 3 places avec accoudoir gauche. D Sofa 3-sitzig mit linker Armlehne. S Sofá de 3 plazas con brazo izquierdo.</p>	<p>COM 3.638,00 L 3.829,00 T 4.057,00 S 4.248,00 Z 4.477,00 K 4.668,00 PS 5.605,00 PF 6.287,00 PX 7.377,00 PA 8.400,00</p>
	<p>KATE00DIVA270</p> <p>I Divano 4 posti. E 4 seater sofa. F Canapé 4 places. D Sofa 4-sitzig. S Sofá de 4 plazas.</p>	<p>COM 4.086,00 L 4.339,00 T 4.645,00 S 4.900,00 Z 5.205,00 K 5.459,00 PS 6.652,00 PF 7.560,00 PX 9.014,00 PA 10.376,00</p>

KATE - Design Matteo Nunziati



KATE00DI260DX
 I Divano 4 posti con bracciolo destro.
 E 4 seater sofa with right arm.
 F Canapé 4 places avec accoudoir droit.
 D Sofa 4-sitzig mit rechter Armlehne.
 S Sofá de 4 plazas con brazo derecho.

cm. 260 x 93 x h 72 – hs 45 • mt. 10.45
 in. 102³/₈ x 36³/₈ x h 28³/₈ – hs 17³/₈ • yd. 11.45

COM	3.880,00
L	4.095,00
T	4.355,00
S	4.570,00
Z	4.829,00
K	5.045,00
PS	6.091,00
PF	6.864,00
PX	8.100,00
PA	9.258,00



KATE00DI260SX
 I Divano 4 posti con bracciolo sinistro.
 E 4 seater sofa with left arm.
 F Canapé 4 places avec accoudoir gauche.
 D Sofa 4-sitzig mit linker Armlehne.
 S Sofá de 4 plazas con brazo izquierdo.

cm. 260 x 93 x h 72 – hs 45 • mt. 10.45
 in. 102³/₈ x 36³/₈ x h 28³/₈ – hs 17³/₈ • yd. 11.45

COM	3.880,00
L	4.095,00
T	4.355,00
S	4.570,00
Z	4.829,00
K	5.045,00
PS	6.091,00
PF	6.864,00
PX	8.100,00
PA	9.258,00

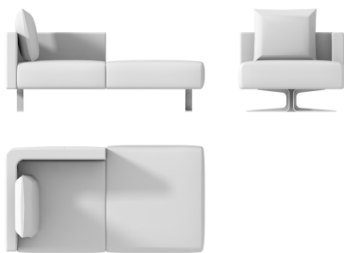

KATE00CH180DX
 I Chaiselongue destra cm. 177
 E Right chaiselongue cm. 177
 F Dormeuse droite cm. 177
 D Rechte Dormeuse cm. 177
 S Chaise longue derecha cm. 177

cm. 93 x 177 x h 72 – hs 45 • mt. 6.95
 in. 36³/₈ x 69³/₈ x h 28³/₈ – hs 17³/₈ • yd. 7.60

COM	3.164,00
L	3.307,00
T	3.478,00
S	3.621,00
Z	3.793,00
K	3.937,00
PS	4.660,00
PF	5.169,00
PX	5.982,00
PA	6.745,00

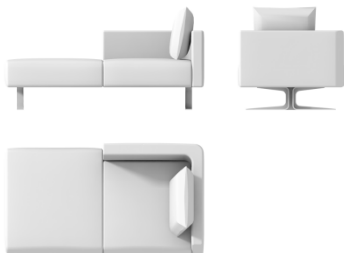

KATE00CH180SX
 I Chaiselongue sinistra cm. 177
 E Left chaiselongue cm. 177
 F Dormeuse gauche cm. 177
 D Linke Dormeuse cm. 177
 S Chaise longue izquierda cm. 177

cm. 93 x 177 x h 72 – hs 45 • mt. 6.95
 in. 36³/₈ x 69³/₈ x h 28³/₈ – hs 17³/₈ • yd. 7.60

COM	3.164,00
L	3.307,00
T	3.478,00
S	3.621,00
Z	3.793,00
K	3.937,00
PS	4.660,00
PF	5.169,00
PX	5.982,00
PA	6.745,00

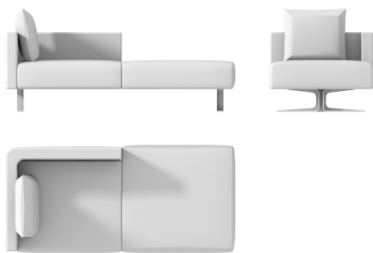

KATE00CH210DX
 I Chaiselongue destra cm. 207
 E Right chaiselongue cm. 207
 F Dormeuse droite cm. 207
 D Rechte Dormeuse cm. 207
 S Chaise longue derecha cm. 207

cm. 93 x 207 x h 72 – hs 45 • mt. 7.15
 in. 36³/₈ x 81³/₈ x h 28³/₈ – hs 17³/₈ • yd. 7.80

COM	3.312,00
L	3.461,00
T	3.638,00
S	3.785,00
Z	3.962,00
K	4.110,00
PS	4.864,00
PF	5.391,00
PX	6.234,00
PA	7.025,00

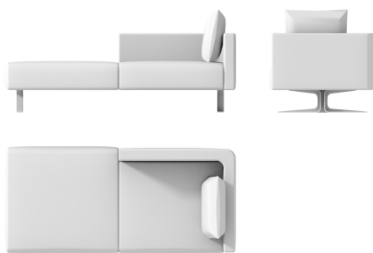

KATE00CH210SX
 I Chaiselongue sinistra cm. 207
 E Left chaiselongue cm. 207
 F Dormeuse gauche cm. 207
 D Linke Dormeuse cm. 207
 S Chaise longue izquierda cm. 207

cm. 93 x 207 x h 72 – hs 45 • mt. 7.15
 in. 36³/₈ x 81³/₈ x h 28³/₈ – hs 17³/₈ • yd. 7.80

COM	3.312,00
L	3.461,00
T	3.638,00
S	3.785,00
Z	3.962,00
K	4.110,00
PS	4.864,00
PF	5.391,00
PX	6.234,00
PA	7.025,00

KATE - Design Matteo Nunziati

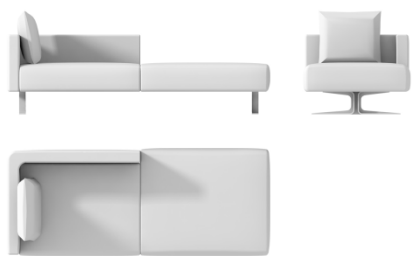

KATE00CH240DX
I Chaiselongue destra cm. 237
E Right chaiselongue cm. 237
F Dormeuse droite cm. 237
D Rechte Dormeuse cm. 237
S Chaise longue derecha cm. 237

cm. 93 x 237 x h 72 – hs 45 • mt. 7.40
 in. 36”% x 93”% x h 28”% – hs 17”% • yd. 8.10

COM	3.495,00
L	3.647,00
T	3.830,00
S	3.982,00
Z	4.164,00
K	4.317,00
PS	5.105,00
PF	5.651,00
PX	6.522,00
PA	7.340,00

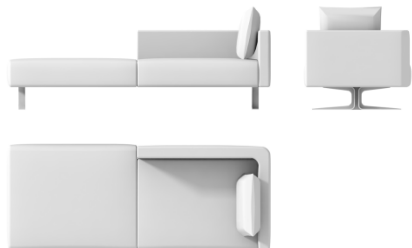

KATE00CH240SX
I Chaiselongue sinistra cm. 237
E Left chaiselongue cm. 237
F Dormeuse gauche cm. 237
D Linke Dormeuse cm. 237
S Chaise longue izquierda cm. 237

cm. 93 x 237 x h 72 – hs 45 • mt. 7.40
 in. 36”% x 93”% x h 28”% – hs 17”% • yd. 8.10

COM	3.495,00
L	3.647,00
T	3.830,00
S	3.982,00
Z	4.164,00
K	4.317,00
PS	5.105,00
PF	5.651,00
PX	6.522,00
PA	7.340,00



KATE00CH270DX
I Chaiselongue destra cm. 267
E Right chaiselongue cm. 267
F Dormeuse droite cm. 267
D Rechte Dormeuse cm. 267
S Chaise longue derecha cm. 267

cm. 93 x 267 x h 72 – hs 45 • mt. 7.70
 in. 36”% x 105”% x h 28”% – hs 17”% • yd. 8.40

COM	3.652,00
L	3.811,00
T	4.003,00
S	4.161,00
Z	4.352,00
K	4.511,00
PS	5.321,00
PF	5.884,00
PX	6.786,00
PA	7.631,00

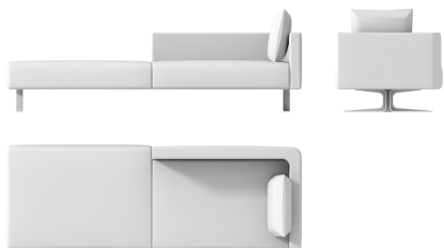

KATE00CH270SX
I Chaiselongue sinistra cm. 267
E Left chaiselongue cm. 267
F Dormeuse gauche cm. 267
D Linke Dormeuse cm. 267
S Chaise longue izquierda cm. 267

cm. 93 x 267 x h 72 – hs 45 • mt. 7.70
 in. 36”% x 105”% x h 28”% – hs 17”% • yd. 8.40

COM	3.652,00
L	3.811,00
T	4.003,00
S	4.161,00
Z	4.352,00
K	4.511,00
PS	5.321,00
PF	5.884,00
PX	6.786,00
PA	7.631,00

KEEN - Design Mauro Lipparini



Struttura. In legno massello di pioppo (stagionato "naturalmente" per almeno 3 anni) con elementi in pannelli di particelle di legno; giunzioni a incastro con spine cilindriche. Il molleggio è garantito da cinghie elastiche in polipropilene e lattice naturale. L'imbottitura della struttura è ottenuta con lastre di poliuretano espanso indeformabile con densità di 70 kg/m³ esente da CFC ricoperto da ovatta poliestere e vellutino accoppiato. Alla struttura è fissato uno schienale d'acciaio disponibile cromato o verniciato a polveri epossidiche in colore RAL a scelta.

Cuscini. Cuscini di seduta disponibili in due varianti: a) in poliuretano espanso a densità differenziate (con densità di 30÷35 kg/m³) ed esente da CFC; b) in poliuretano espanso a densità differenziate (con densità di 30÷35 kg/m³) ed esente da CFC e in piuma nella parte superiore e frontale. I cuscini di schienale sono completamente in piuma canalizzata.

Base. Basamento in tubolare d'acciaio disponibile cromato o verniciato a polveri epossidiche in colore RAL a scelta.

Rivestimento. Disponibile in tessuto e pelle; sfoderabile solo nella versione in tessuto.

Frame. In solid poplar heartwood ("naturally" seasoned for at least 3 years) with connecting elements in particleboard panel; dap joints with cylindrical dowels. The webbing is secured by elastic polypropylene and natural latex belts. The framework is upholstered with contoured sheets of resilient, CFC-free polyurethane foam with density of 70 kg/m³ covered by polyester wadding and bonded plush. A back support in steel is fixed to the frame; it is available chromed or epoxy powder painted in RAL colors of your choice.

Cushions. The seat cushions are in two versions: a) CFC-free polyurethane foam with different density of 30÷35 kg/m³; b) CFC-free polyurethane foam with different density of 30÷35 kg/m³ and feather in the upper and front part of the cushion. The back cushions are feather-filled.

Base. Base in tubular steel available chromed or epoxy powder painted in RAL colors of your choice.

Covers. Available in fabric or leather; removable covers only for fabric version.



I Poltrona cm. 112 con base verniciata e cuscino di seduta in piuma (PI) o poliuretano (GO).
E Armchair cm. 112 with painted base and feather (PI) or polyurethane (GO) seat cushion.
F Fauteuil cm. 112 avec pied verni et coussin de l'assise en plume (PI) ou en poliuretano (GO).
D Sessel cm. 112 mit lackiertem Fuss und Daunen (PI) oder Polyurethan (GO) Sitzkissen.
S Butaca cm. 112 con base pintada y cojín de asiento de pluma (PI) o de poliuretano (GO).

cm. 112 x 100 x h 85 – hs 39 • mt. 7.10
 in. 44¹/₂ x 39³/₄ x h 33¹/₂ – hs 15³/₄ • yd. 7.75

	KEEN00PO112PI PI	KEEN00PO112GO GO
COM	2.756,00	COM 2.795,00
L	2.900,00	L 2.939,00
T	3.074,00	T 3.112,00
S	3.217,00	S 3.256,00
Z	3.390,00	Z 3.429,00
K	3.534,00	K 3.573,00
PS	4.304,00	PS 4.344,00
PF	4.813,00	PF 4.851,00
PX	5.927,00	PX 5.965,00
PA	6.766,00	PA 6.805,00



I Poltrona con bracciolo destro cm. 90 con base verniciata e cuscino di seduta in piuma (PI) o poliuretano (GO).
E Armchair with right arm cm. 90 with painted base and feather (PI) or polyurethane (GO) seat cushion.
F Fauteuil avec accoudoir droit cm. 90 avec pied verni et coussin de l'assise en plume (PI) ou en poliuretano (GO).
D Sessel mit rechter Armlehne cm. 90 mit lackiertem Fuss und Daunen (PI) oder Polyurethan (GO) Sitzkissen.
S Butaca con brazo derecho cm. 90 con base pintada y cojín de asiento de pluma (PI) o de poliuretano (GO).

cm. 90 x 100 x h 85 – hs 39 • mt. 6.20
 in. 35¹/₂ x 39³/₄ x h 33¹/₂ – hs 15³/₄ • yd. 6.80

	KEEN00DX090PI PI	KEEN00DX090GO GO
COM	2.538,00	COM 2.522,00
L	2.664,00	L 2.648,00
T	2.815,00	T 2.800,00
S	2.941,00	S 2.925,00
Z	3.092,00	Z 3.077,00
K	3.218,00	K 3.202,00
PS	3.913,00	PS 3.898,00
PF	4.358,00	PF 4.342,00
PX	5.331,00	PX 5.316,00
PA	6.067,00	PA 6.052,00



I Poltrona con bracciolo sinistro cm. 90 con base verniciata e cuscino di seduta in piuma (PI) o poliuretano (GO).
E Armchair with left arm cm. 90 with painted base and feather (PI) or polyurethane (GO) seat cushion.
F Fauteuil avec accoudoir gauche cm. 90 avec pied verni et coussin de l'assise en plume (PI) ou en poliuretano (GO).
D Sessel mit linker Armlehne cm. 90 mit lackiertem Fuss und Daunen (PI) oder Polyurethan (GO) Sitzkissen.
S Butaca con brazo izquierdo cm. 90 con base pintada y cojín de asiento de pluma (PI) o de poliuretano (GO).

cm. 90 x 100 x h 85 – hs 39 • mt. 6.20
 in. 35¹/₂ x 39³/₄ x h 33¹/₂ – hs 15³/₄ • yd. 6.80

	KEEN00SX090PI PI	KEEN00SX090GO GO
COM	2.538,00	COM 2.522,00
L	2.664,00	L 2.648,00
T	2.815,00	T 2.800,00
S	2.941,00	S 2.925,00
Z	3.092,00	Z 3.077,00
K	3.218,00	K 3.202,00
PS	3.913,00	PS 3.898,00
PF	4.358,00	PF 4.342,00
PX	5.331,00	PX 5.316,00
PA	6.067,00	PA 6.052,00

KEEN - Design Mauro Lipparini



I Poltrona cm. 128 con base verniciata e cuscino di seduta in piuma (PI) o poliuretano (GO).
 E Armchair cm. 128 with painted base and feather (PI) or polyurethane (GO) seat cushion.
 F Fauteuil cm. 128 avec pied verni et coussin de l'assise en plume (PI) ou en poliuretano (GO).
 D Sessel cm. 128 mit lackiertem Fuss und Daunen (PI) oder Polyurethan (GO) Sitzkissen.
 S Butaca cm. 128 con base pintada y cojín de asiento de pluma (PI) o de poliuretano (GO).

cm. 128 x 100 x h 85 – hs 39 • mt. 8.00
 in. 50³/₈ x 39³/₈ x h 33¹/₂ – hs 15³/₈ • yd. 8.75

	KEEN00PO128PI	KEEN00PO128GO
COM	2.839,00	2.888,00
L	3.000,00	3.050,00
T	3.195,00	3.245,00
S	3.357,00	3.406,00
Z	3.551,00	3.601,00
K	3.713,00	3.763,00
PS	4.561,00	4.610,00
PF	5.132,00	5.182,00
PX	6.386,00	6.435,00
PA	7.331,00	7.380,00



I Poltrona con bracciolo destro cm. 106 con base verniciata e cuscino di seduta in piuma (PI) o poliuretano (GO).
 E Armchair with right arm cm. 106 with painted base and feather (PI) or polyurethane (GO) seat cushion.
 F Fauteuil avec accoudoir droit cm. 106 avec pied verni et coussin de l'assise en plume (PI) ou en poliuretano (GO).
 D Sessel mit rechter Armlehne cm. 106 mit lackiertem Fuss und Daunen (PI) oder Polyurethan (GO) Sitzkissen.
 S Butaca con brazo derecho cm. 106 con base pintada y cojín de asiento de pluma (PI) o de poliuretano (GO).

cm. 106 x 100 x h 85 – hs 39 • mt. 7.10
 in. 41³/₈ x 39³/₈ x h 33¹/₂ – hs 15³/₈ • yd. 7.75

	KEEN00DX106PI	KEEN00DX106GO
COM	2.531,00	2.580,00
L	2.675,00	2.724,00
T	2.848,00	2.897,00
S	2.991,00	3.041,00
Z	3.164,00	3.214,00
K	3.308,00	3.358,00
PS	4.060,00	4.110,00
PF	4.569,00	4.619,00
PX	5.683,00	5.732,00
PA	6.523,00	6.572,00



I Poltrona con bracciolo sinistro cm. 106 con base verniciata e cuscino di seduta in piuma (PI) o poliuretano (GO).
 E Armchair with left arm cm. 106 with painted base and feather (PI) or polyurethane (GO) seat cushion.
 F Fauteuil avec accoudoir gauche cm. 106 avec pied verni et coussin de l'assise en plume (PI) ou en poliuretano (GO).
 D Sessel mit linker Armlehne cm. 106 mit lackiertem Fuss und Daunen (PI) oder Polyurethan (GO) Sitzkissen.
 S Butaca con brazo izquierdo cm. 106 con base pintada y cojín de asiento de pluma (PI) o de poliuretano (GO).

cm. 106 x 100 x h 85 – hs 39 • mt. 7.10
 in. 41³/₈ x 39³/₈ x h 33¹/₂ – hs 15³/₈ • yd. 7.75

	KEEN00SX106PI	KEEN00SX106GO
COM	2.531,00	2.580,00
L	2.675,00	2.724,00
T	2.848,00	2.897,00
S	2.991,00	3.041,00
Z	3.164,00	3.214,00
K	3.308,00	3.358,00
PS	4.060,00	4.110,00
PF	4.569,00	4.619,00
PX	5.683,00	5.732,00
PA	6.523,00	6.572,00



I Elemento centrale cm. 100, con base verniciata e cuscino di seduta in piuma (PI) o poliuretano (GO).
 E Central unit cm. 100, with painted base and feather (PI) or polyurethane (GO) seat cushion.
 F Élément central cm. 100, avec pied verni et coussin de l'assise en plume (PI) ou en poliuretano (GO).
 D Zentral Element cm. 100, mit lackiertem Fuss und Daunen (PI) oder Polyurethan (GO) Sitzkissen.
 S Módulo central cm. 100 con base pintada y cojín de asiento de pluma (PI) o de poliuretano (GO).

cm. 100 x 100 x h 85 – hs 39 • mt. 5.30
 in. 39³/₈ x 39³/₈ x h 33¹/₂ – hs 15³/₈ • yd. 5.80

	KEEN00CE100PI	KEEN00CE100GO
COM	2.335,00	2.358,00
L	2.443,00	2.466,00
T	2.573,00	2.596,00
S	2.681,00	2.704,00
Z	2.811,00	2.833,00
K	2.918,00	2.941,00
PS	3.574,00	3.597,00
PF	3.956,00	3.979,00
PX	4.791,00	4.812,00
PA	5.421,00	5.444,00



I Divano 2 posti cm. 180 con base verniciata e cuscini di seduta in piuma (PI).
 E 2 seater sofa cm. 180 with painted base and feather (PI) seat cushions.
 F Canapé 2 places cm. 180 avec pied verni et coussins de l'assise en plume (PI).
 D Sofa 2-sitzig cm. 180 mit lackiertem Fuss und Daunen (PI) Sitzkissen.
 S Sofá de 2 plazas cm. 180 con base pintada y cojines de asiento de pluma (PI).

cm. 180 x 100 x h 85 – hs 39 • mt. 9.50
 in. 70³/₈ x 39³/₈ x h 33¹/₂ – hs 15³/₈ • yd. 10.40

	KEEN00DI180PI
COM	3.757,00
L	3.958,00
T	4.198,00
S	4.398,00
Z	4.639,00
K	4.839,00
PS	5.837,00
PF	6.544,00
PX	8.091,00
PA	9.259,00

KEEN - Design Mauro Lipparini



I Divano 2 posti cm. 180 con base verniciata e cuscini di seduta in poliuretano (GO).
 E 2 seater sofa cm. 180 with painted base and polyurethane (GO) seat cushions.
 F Canapé 2 places cm. 180 avec pied verni et coussins de l'assise en poliuretano (GO).
 D Sofa 2-sitzig cm. 180 mit lackiertem Fuss und Polyurethan (GO) Sitzkissen.
 S Sofá de 2 plazas cm. 180 con base pintada y cojines de asiento de poliuretano (GO).

cm. 180 x 100 x h 85 – hs 39 • mt. 9.50
 in. 70³/₄ x 39³/₄ x h 33¹/₂ – hs 15³/₄ • yd. 10.40

KEEN00D180GO	
GO	
COM	3.445,00
L	3.638,00
T	3.871,00
S	4.064,00
Z	4.296,00
K	4.490,00
PS	5.541,00
PF	6.248,00
PX	7.796,00
PA	8.963,00



I Divano 2 posti con bracciolo destro, base verniciata e cuscini di seduta in piuma (PI).
 E 2 seater sofa with right arm, painted base and feather (PI) seat cushions.
 F Canapé 2 places avec accoudoir droit, pied verni et coussins de l'assise en plume (PI).
 D Sofa 2-sitzig mit rechter Armlehne, lackiertem Fuss und Daunen (PI) Sitzkissen.
 S Sofá de 2 plazas con brazo derecho, base pintada y cojines de asiento de pluma (PI).

cm. 158 x 100 x h 85 – hs 39 • mt. 8.90
 in. 62¹/₄ x 39³/₄ x h 33¹/₂ – hs 15³/₄ • yd. 9.75

KEEN00DX158PI	
PI	
COM	3.608,00
L	3.789,00
T	4.009,00
S	4.191,00
Z	4.409,00
K	4.592,00
PS	5.514,00
PF	6.157,00
PX	7.564,00
PA	8.627,00



I Divano 2 posti con bracciolo destro, base verniciata e cuscini di seduta in poliuretano (GO).
 E 2 seater sofa with right arm, painted base and polyurethane (GO) seat cushions.
 F Canapé 2 places avec accoudoir droit, pied verni et coussins de l'assise en poliuretano (GO).
 D Sofa 2-sitzig mit rechter Armlehne, lackiertem Fuss und Polyurethan (GO) Sitzkissen.
 S Sofá de 2 plazas con brazo derecho, base pintada y cojines de asiento de poliuretano (GO).

cm. 158 x 100 x h 85 – hs 39 • mt. 8.90
 in. 62¹/₄ x 39³/₄ x h 33¹/₂ – hs 15³/₄ • yd. 9.75

KEEN00DX158GO	
GO	
COM	3.305,00
L	3.480,00
T	3.692,00
S	3.867,00
Z	4.078,00
K	4.253,00
PS	5.143,00
PF	5.759,00
PX	7.110,00
PA	8.130,00



I Divano 2 posti con bracciolo sinistro, base verniciata e cuscini di seduta in piuma (PI).
 E 2 seater sofa with left arm, painted base and feather (PI) seat cushions.
 F Canapé 2 places avec accoudoir gauche, pied verni et coussins de l'assise en plume (PI).
 D Sofa 2-sitzig mit linker Armlehne, lackiertem Fuss und Daunen (PI) Sitzkissen.
 S Sofá de 2 plazas con brazo izquierdo, base pintada y cojines de asiento de pluma (PI).

cm. 158 x 100 x h 85 – hs 39 • mt. 8.90
 in. 62¹/₄ x 39³/₄ x h 33¹/₂ – hs 15³/₄ • yd. 9.75

KEEN00SX158PI	
PI	
COM	3.608,00
L	3.789,00
T	4.009,00
S	4.191,00
Z	4.409,00
K	4.592,00
PS	5.514,00
PF	6.157,00
PX	7.564,00
PA	8.627,00



I Divano 2 posti con bracciolo sinistro, base verniciata e cuscini di seduta in poliuretano (GO).
 E 2 seater sofa with left arm, painted base and polyurethane (GO) seat cushions.
 F Canapé 2 places avec accoudoir gauche, pied verni et coussins de l'assise en poliuretano (GO).
 D Sofa 2-sitzig mit linker Armlehne, lackiertem Fuss und Polyurethan (GO) Sitzkissen.
 S Sofá de 2 plazas con brazo izquierdo, base pintada y cojines de asiento de poliuretano (GO).

cm. 158 x 100 x h 85 – hs 39 • mt. 8.90
 in. 62¹/₄ x 39³/₄ x h 33¹/₂ – hs 15³/₄ • yd. 9.75

KEEN00SX158GO	
GO	
COM	3.305,00
L	3.480,00
T	3.692,00
S	3.867,00
Z	4.078,00
K	4.253,00
PS	5.143,00
PF	5.759,00
PX	7.110,00
PA	8.130,00

KEEN - Design Mauro Lipparini



I Divano 2 posti cm. 210 con base verniciata e cuscini di seduta in piuma (PI) o poliuretano (GO).
E 2 seater sofa cm. 210 with painted base and feather (PI) or polyurethane (GO) seat cushions.
F Canapé 2 places cm. 210 avec pied verni et coussins de l'assise en plume (PI) ou en poliuretano (GO).
D Sofa 2-sitzig cm. 210 mit lackiertem Fuss und Daunen (PI) oder Polyurethan (GO) Sitzkissen.
S Sofá de 2 plazas cm. 210 con base pintada y cojines de asiento de pluma (PI) o de poliuretano (GO).

cm. 210 x 100 x h 85 – hs 39 • mt. 11.50
 in. 82³/₈ x 39³/₈ x h 33³/₈ – hs 15³/₈ • yd. 12.60

	KEEN00DI210PI		KEEN00DI210GO
	PI		GO
COM	3.949,00	COM	3.743,00
L	4.183,00	L	3.977,00
T	4.464,00	T	4.258,00
S	4.698,00	S	4.492,00
Z	4.978,00	Z	4.773,00
K	5.212,00	K	5.007,00
PS	6.315,00	PS	6.109,00
PF	7.138,00	PF	6.932,00
PX	8.938,00	PX	8.732,00
PA	10.298,00	PA	10.092,00



I Divano 2 posti con bracciolo destro, base verniciata e cuscini di seduta in piuma (PI) o poliuretano (GO).
E 2 seater sofa with right arm, painted base and feather (PI) or polyurethane (GO) seat cushions.
F Canapé 2 places avec accoudoir droit, pied verni et coussins de l'assise en plume (PI) ou en poliuretano (GO).
D Sofa 2-sitzig mit rechter Armlehne, lackiertem Fuss und Daunen (PI) oder Polyurethan (GO) Sitzkissen.
S Sofá de 2 plazas con brazo derecho, base pintada y cojines de asiento de pluma (PI) o de poliuretano (GO).

cm. 188 x 100 x h 85 – hs 39 • mt. 10.50
 in. 74" x 39³/₈ x h 33³/₈ – hs 15³/₈ • yd. 11.50

	KEEN00DX188PI		KEEN00DX188GO
	PI		GO
COM	4.035,00	COM	3.829,00
L	4.250,00	L	4.045,00
T	4.509,00	T	4.303,00
S	4.726,00	S	4.520,00
Z	4.984,00	Z	4.778,00
K	5.200,00	K	4.994,00
PS	6.226,00	PS	6.021,00
PF	6.988,00	PF	6.782,00
PX	8.647,00	PX	8.442,00
PA	9.902,00	PA	9.696,00



I Divano 2 posti con bracciolo sinistro, base verniciata e cuscini di seduta in piuma (PI) o poliuretano (GO).
E 2 seater sofa with left arm, painted base and feather (PI) or polyurethane (GO) seat cushions.
F Canapé 2 places avec accoudoir gauche, pied verni et coussins de l'assise en plume (PI) ou en poliuretano (GO).
D Sofa 2-sitzig mit linker Armlehne, lackiertem Fuss und Daunen (PI) oder Polyurethan (GO) Sitzkissen.
S Sofá de 2 plazas con brazo izquierdo, base pintada y cojines de asiento de pluma (PI) o de poliuretano (GO).

cm. 188 x 100 x h 85 – hs 39 • mt. 10.50
 in. 74" x 39³/₈ x h 33³/₈ – hs 15³/₈ • yd. 11.50

	KEEN00SX188PI		KEEN00SX188GO
	PI		GO
COM	4.035,00	COM	3.829,00
L	4.250,00	L	4.045,00
T	4.509,00	T	4.303,00
S	4.726,00	S	4.520,00
Z	4.984,00	Z	4.778,00
K	5.200,00	K	4.994,00
PS	6.226,00	PS	6.021,00
PF	6.988,00	PF	6.782,00
PX	8.647,00	PX	8.442,00
PA	9.902,00	PA	9.696,00



I Divano 3 posti con base verniciata e cuscini di seduta in piuma (PI) o poliuretano (GO).
E 3 seater sofa with painted base and feather (PI) or polyurethane (GO) seat cushions.
F Canapé 3 places avec pied verni et coussins de l'assise en plume (PI) ou en poliuretano (GO).
D Sofa 3-sitzig mit lackiertem Fuss und Daunen (PI) oder Polyurethan (GO) Sitzkissen.
S Sofá de 3 plazas con base pintada y cojines de asiento de pluma (PI) o de poliuretano (GO).

cm. 240 x 100 x h 85 – hs 39 • mt. 13.00
 in. 94¹/₂ x 39³/₈ x h 33³/₈ – hs 15³/₈ • yd. 14.20

	KEEN00DI240PI		KEEN00DI240GO
	PI		GO
COM	4.450,00	COM	4.251,00
L	4.710,00	L	4.516,00
T	5.023,00	T	4.835,00
S	5.285,00	S	5.100,00
Z	5.598,00	Z	5.419,00
K	5.859,00	K	5.684,00
PS	7.047,00	PS	6.879,00
PF	7.965,00	PF	7.812,00
PX	9.968,00	PX	9.849,00
PA	11.483,00	PA	11.388,00



I Divano 3 posti con bracciolo destro, base verniciata e cuscini di seduta in piuma (PI) o poliuretano (GO).
E 3 seater sofa with right arm, painted base and feather (PI) or polyurethane (GO) seat cushions.
F Canapé 3 places avec accoudoir droit, pied verni et coussins de l'assise en plume (PI) ou en poliuretano (GO).
D Sofa 3-sitzig mit rechter Armlehne, lackiertem Fuss und Daunen (PI) oder Polyurethan (GO) Sitzkissen.
S Sofá de 3 plazas con brazo derecho. Base pintada y cojines de asiento de pluma (PI) o de poliuretano (GO).

cm. 218 x 100 x h 85 – hs 39 • mt. 12.10
 in. 85³/₈ x 39³/₈ x h 33³/₈ – hs 15³/₈ • yd. 13.25

	KEEN00DX218PI		KEEN00DX218GO
	PI		GO
COM	4.346,00	COM	4.101,00
L	4.611,00	L	4.349,00
T	4.930,00	T	4.646,00
S	5.194,00	S	4.894,00
Z	5.514,00	Z	5.190,00
K	5.778,00	K	5.437,00
PS	6.711,00	PS	6.558,00
PF	7.566,00	PF	7.426,00
PX	9.430,00	PX	9.325,00
PA	10.841,00	PA	10.758,00

KEEN - Design Mauro Lipparini



I Divano 3 posti con bracciolo sinistro, base verniciata e cuscini di seduta in piuma (PI) o poliuretano (GO).
E 3 seater sofa with left arm, painted base and feather (PI) or polyurethane (GO) seat cushions.
F Canapé 3 places avec accoudoir gauche, pied verni et coussins de l'assise en plume (PI) ou en poliuretano (GO).
D Sofa 3-sitzig mit linker Armlehne, lackiertem Fuss und Daunen (PI) oder Polyurethan (GO) Sitzkissen.
S Sofá de 3 plazas con brazo izquierdo. Base pintada y cojines de asiento de pluma (PI) o de poliuretano (GO).

cm. 218 x 100 x h 85 – hs 39 • mt. 12.10
 in. 85³/₈ x 39³/₈ x h 33³/₈ – hs 15³/₈ • yd. 13.25

KEEN00SX218PI		KEEN00SX218GO	
	PI		GO
COM	4.346,00	COM	4.101,00
L	4.611,00	L	4.349,00
T	4.930,00	T	4.646,00
S	5.194,00	S	4.894,00
Z	5.514,00	Z	5.190,00
K	5.778,00	K	5.437,00
PS	6.711,00	PS	6.558,00
PF	7.566,00	PF	7.426,00
PX	9.430,00	PX	9.325,00
PA	10.841,00	PA	10.758,00



I Divano 4 posti con base verniciata e cuscini di seduta in piuma (PI) o poliuretano (GO).
E 4 seater sofa with painted base and feather (PI) or polyurethane (GO) seat cushions.
F Canapé 4 places avec pied verni et coussins de l'assise en plume (PI) ou en poliuretano (GO).
D Sofa 4-sitzig mit lackiertem Fuss und Daunen (PI) oder Polyurethan (GO) Sitzkissen.
S Sofá de 4 plazas con base pintada y cojines de asiento de pluma (PI) o de poliuretano (GO).

cm. 270 x 100 x h 85 – hs 39 • mt. 14.50
 in. 106³/₈ x 39³/₈ x h 33³/₈ – hs 15³/₈ • yd. 15.85

KEEN00DI270PI		KEEN00DI270GO	
	PI		GO
COM	5.151,00	COM	4.925,00
L	5.444,00	L	5.218,00
T	5.794,00	T	5.569,00
S	6.086,00	S	5.862,00
Z	6.438,00	Z	6.212,00
K	6.730,00	K	6.504,00
PS	8.070,00	PS	7.844,00
PF	9.096,00	PF	8.870,00
PX	11.337,00	PX	11.112,00
PA	13.031,00	PA	12.806,00



I Divano 4 posti con bracciolo destro, base verniciata e cuscini di seduta in piuma (PI) o poliuretano (GO).
E 4 seater sofa with right arm, painted base and feather (PI) or polyurethane (GO) seat cushions.
F Canapé 4 places avec accoudoir droit, pied verni et coussins de l'assise en plume (PI) ou en poliuretano (GO).
D Sofa 4-sitzig mit rechter Armlehne, lackiertem Fuss und Daunen (PI) oder Polyurethan (GO) Sitzkissen.
S Sofá de 4 plazas con brazo derecho. Base pintada y cojines de asiento de pluma (PI) o de poliuretano (GO).

cm. 248 x 100 x h 85 – hs 39 • mt. 13.60
 in. 97³/₈ x 39³/₈ x h 33³/₈ – hs 15³/₈ • yd. 14.90

KEEN00DX248PI		KEEN00DX248GO	
	PI		GO
COM	4.916,00	COM	4.692,00
L	5.193,00	L	4.968,00
T	5.525,00	T	5.300,00
S	5.802,00	S	5.576,00
Z	6.134,00	Z	5.909,00
K	6.411,00	K	6.185,00
PS	7.685,00	PS	7.460,00
PF	8.657,00	PF	8.432,00
PX	10.786,00	PX	10.561,00
PA	12.392,00	PA	12.166,00



I Divano 4 posti con bracciolo sinistro, base verniciata e cuscini di seduta in piuma (PI) o poliuretano (GO).
E 4 seater sofa with left arm, painted base and feather (PI) or polyurethane (GO) seat cushions.
F Canapé 4 places avec accoudoir gauche, pied verni et coussins de l'assise en plume (PI) ou en poliuretano (GO).
D Sofa 4-sitzig mit linker Armlehne, lackiertem Fuss und Daunen (PI) oder Polyurethan (GO) Sitzkissen.
S Sofá de 4 plazas con brazo izquierdo. Base pintada y cojines de asiento de pluma (PI) o de poliuretano (GO).

cm. 248 x 100 x h 85 – hs 39 • mt. 13.60
 in. 97³/₈ x 39³/₈ x h 33³/₈ – hs 15³/₈ • yd. 14.90

KEEN00SX248PI		KEEN00SX248GO	
	PI		GO
COM	4.916,00	COM	4.692,00
L	5.193,00	L	4.968,00
T	5.525,00	T	5.300,00
S	5.802,00	S	5.576,00
Z	6.134,00	Z	5.909,00
K	6.411,00	K	6.185,00
PS	7.685,00	PS	7.460,00
PF	8.657,00	PF	8.432,00
PX	10.786,00	PX	10.561,00
PA	12.392,00	PA	12.166,00



I Dormeuse angolare destra con base verniciata e cuscini di seduta in piuma (PI) o poliuretano (GO).
E Right angular chaiselongue with painted base and feather (PI) or polyurethane (GO) seat cushion.
F Dormeuse angulaire droite avec pied verni et coussin de l'assise en plume (PI) ou en poliuretano (GO).
D Rechte winkelige Dormeuse mit lackiertem Fuss und Daunen (PI) oder Polyurethan (GO) Sitzkissen.
S Chaise longue con rincón derecho – base pintada y cojines de asiento de pluma (PI) o de poliuretano (GO).

cm. 100 x 188 x h 85 – hs 39 • mt. 10.30
 in. 39³/₈ x 74³/₈ x h 33³/₈ – hs 15³/₈ • yd. 11.25

KEEN00DORDXPI		KEEN00DORDXGO	
	PI		GO
COM	3.740,00	COM	3.538,00
L	3.949,00	L	3.747,00
T	4.200,00	T	3.997,00
S	4.409,00	S	4.207,00
Z	4.661,00	Z	4.458,00
K	4.870,00	K	4.667,00
PS	5.878,00	PS	5.675,00
PF	6.616,00	PF	6.414,00
PX	8.227,00	PX	8.025,00
PA	9.445,00	PA	9.243,00

KEEN - Design Mauro Lipparini



I Dormeuse angolare sinistra con base verniciata e cuscini di seduta in piuma (PI) o poliuretano (GO).
E Left angular chaiselongue with painted base and feather (PI) or polyurethane (GO) seat cushion.
F Dormeuse angulaire gauche avec pied verni et coussin de l'assise en plume (PI) ou en poliuretano (GO).
D Linke winkelige Dormeuse mit lackiertem Fuss und Daunen (PI) oder Polyurethan (GO) Sitzkissen.
S Chaise longue con rincón izquierdo – base pintada y cojines de asiento de pluma (PI) o de poliuretano (GO).

cm. 100 x 188 x h 85 – hs 39 • mt. 10.30
 in. 39³/₈ x 74¹/₂ x h 33¹/₂ – hs 15³/₈ • yd. 11.25

KEEN00DORSXPI PI		KEEN00DORSXGO GO	
COM	3.740,00	COM	3.538,00
L	3.949,00	L	3.747,00
T	4.200,00	T	3.997,00
S	4.409,00	S	4.207,00
Z	4.661,00	Z	4.458,00
K	4.870,00	K	4.667,00
PS	5.878,00	PS	5.675,00
PF	6.616,00	PF	6.414,00
PX	8.227,00	PX	8.025,00
PA	9.445,00	PA	9.243,00



I Dormeuse lineare destra con base verniciata e cuscini di seduta in piuma (PI) o poliuretano (GO).
E Right linear chaiselongue with painted base and feather (PI) or polyurethane (GO) seat cushion.
F Dormeuse linéaire droite avec pied verni et coussin de l'assise en plume (PI) ou en poliuretano (GO).
D Rechte lineare Dormeuse mit lackiertem Fuss und Daunen (PI) oder Polyurethan (GO) Sitzkissen.
S Chaise longue lineal derecha – base pintada y cojines de asiento de pluma (PI) o de poliuretano (GO).

cm. 100 x 188 x h 85 – hs 39 • mt. 10.00
 in. 39³/₈ x 74¹/₂ x h 33¹/₂ – hs 15³/₈ • yd. 10.95

KEEN00PENDXPI PI		KEEN00PENDXGO GO	
COM	3.694,00	COM	3.503,00
L	3.899,00	L	3.707,00
T	4.145,00	T	3.953,00
S	4.349,00	S	4.158,00
Z	4.595,00	Z	4.403,00
K	4.800,00	K	4.608,00
PS	5.787,00	PS	5.595,00
PF	6.507,00	PF	6.315,00
PX	8.075,00	PX	7.884,00
PA	9.263,00	PA	9.072,00



I Dormeuse lineare sinistra con base verniciata e cuscini di seduta in piuma (PI) o poliuretano (GO).
E Left linear chaiselongue with painted base and feather (PI) or polyurethane (GO) seat cushion.
F Dormeuse linéaire gauche avec pied verni et coussin de l'assise en plume (PI) ou en poliuretano (GO).
D Linke lineare Dormeuse mit lackiertem Fuss und Daunen (PI) oder Polyurethan (GO) Sitzkissen.
S Chaise longue lineal izquierda – base pintada y cojines de asiento de pluma (PI) o de poliuretano (GO).

cm. 100 x 188 x h 85 – hs 39 • mt. 10.00
 in. 39³/₈ x 74¹/₂ x h 33¹/₂ – hs 15³/₈ • yd. 10.95

KEEN00PENSXPI PI		KEEN00PENSXGO GO	
COM	3.694,00	COM	3.503,00
L	3.899,00	L	3.707,00
T	4.145,00	T	3.953,00
S	4.349,00	S	4.158,00
Z	4.595,00	Z	4.403,00
K	4.800,00	K	4.608,00
PS	5.787,00	PS	5.595,00
PF	6.507,00	PF	6.315,00
PX	8.075,00	PX	7.884,00
PA	9.263,00	PA	9.072,00



I Pouff cm. 85x70 con base verniciata e cuscino di seduta in piuma (PI) o poliuretano (GO).
E Ottoman cm. 85x70 with painted base and feather (PI) or polyurethane (GO) seat cushion.
F Pouf cm. 85x70 avec pied verni et coussin de l'assise en plume (PI) ou en poliuretano (GO).
D Hocker cm. 85x70 mit lackiertem Fuss und Daunen (PI) oder Polyurethan (GO) Sitzkissen.
S Pouf cm. 85x70 con base pintada y cojín de asiento de pluma (PI) o de poliuretano (GO).

cm. 85 x 70 x h 39 – hs 39 • mt. 3.65
 in. 33¹/₂ x 27¹/₂ x h 15³/₈ – hs 15³/₈ • yd. 4.00

KEEN00PU070PI PI		KEEN00PU070GO GO	
COM	1.240,00	COM	1.202,00
L	1.314,00	L	1.277,00
T	1.403,00	T	1.366,00
S	1.477,00	S	1.440,00
Z	1.567,00	Z	1.530,00
K	1.641,00	K	1.604,00
PS	2.018,00	PS	1.951,00
PF	2.278,00	PF	2.203,00
PX	2.852,00	PX	2.762,00
PA	3.285,00	PA	3.182,00



I Pouff cm. 100x100 con base verniciata e cuscino di seduta in piuma (PI) o poliuretano (GO).
E Ottoman cm. 100x100 with painted base and feather (PI) or polyurethane (GO) seat cushion.
F Pouf cm. 100x100 avec pied verni et coussin de l'assise en plume (PI) ou en poliuretano (GO).
D Hocker cm. 100x100 mit lackiertem Fuss und Daunen (PI) oder Polyurethan (GO) Sitzkissen.
S Pouf cm. 100x100 con base pintada y cojín de asiento de pluma (PI) o de poliuretano (GO).

cm. 100 x 100 x h 39 – hs 39 • mt. 4.30
 in. 39³/₈ x 39³/₈ x h 15³/₈ – hs 15³/₈ • yd. 4.70

KEEN00PU100PI PI		KEEN00PU100GO GO	
COM	1.547,00	COM	1.482,00
L	1.636,00	L	1.570,00
T	1.741,00	T	1.675,00
S	1.828,00	S	1.763,00
Z	1.933,00	Z	1.868,00
K	2.021,00	K	1.956,00
PS	2.468,00	PS	2.402,00
PF	2.778,00	PF	2.713,00
PX	3.458,00	PX	3.392,00
PA	3.971,00	PA	3.905,00

KEEN - Design Mauro Lipparini



I Pouff cm. 180x100 con base verniciata e cuscini di seduta in piuma (PI).
 E Ottoman cm. 180x100 with painted base and feather (PI) seat cushions.
 F Pouf cm. 180x100 avec pied verni et coussins de l'assise en plume (PI).
 D Hocker cm. 180x100 mit lackiertem Fuss und Daunen (PI) Sitzkissen.
 S Pouf cm. 180x100 con base pintada y cojín de asiento de pluma (PI).

cm. 180 x 100 x h 39 - hs 39 • mt. 7.60
 in. 70³/₈ x 39³/₈ x h 15³/₈ - hs 15³/₈ • yd. 8.30

KEEN00PU180PI PI	
COM	2.584,00
L	2.740,00
T	2.925,00
S	3.081,00
Z	3.267,00
K	3.423,00
PS	4.181,00
PF	4.730,00
PX	5.935,00
PA	6.842,00



I Pouff cm. 180x100 con base verniciata e cuscini di seduta in poliuretano (GO).
 E Ottoman cm. 180x100 with painted base and polyurethane (GO) seat cushions.
 F Pouf cm. 180x100 avec pied verni et coussins de l'assise en poliuretano (GO).
 D Hocker cm. 180x100 mit lackiertem Fuss und Polyurethan (GO) Sitzkissen.
 S Pouf cm. 180x100 con base pintada y cojín de asiento de poliuretano (GO).

cm. 180 x 100 x h 39 - hs 39 • mt. 7.60
 in. 70³/₈ x 39³/₈ x h 15³/₈ - hs 15³/₈ • yd. 8.30

KEEN00PU180GO GO	
COM	2.230,00
L	2.385,00
T	2.572,00
S	2.726,00
Z	2.913,00
K	3.068,00
PS	3.827,00
PF	4.375,00
PX	5.581,00
PA	6.488,00



ADLOOKCUSCINE

I Cuscino cm. 50x40.
 E Pillow cm. 50x40.
 F Coussin cm. 50x40.
 D Kissen cm. 50x40.
 S Cojín cm. 50x40.

cm. 50 x 40 x h 10 • mt. 0.70
 in. 19³/₈ x 15³/₈ x h 3³/₈ • yd. 0.75

COM	123,00
L	136,00
T	152,00
S	166,00
Z	181,00
K	195,00
PS	209,00
PF	247,00
PX	334,00
PA	397,00



KEEN00SCHICRO

I Supplemento per schienale in acciaio cromato con relativo cuscino accoppiato per angolo destro o sinistro.
 E Extra charge for chromed back with its relative back cushion matching for angle element right or left.
 F Supplément pour dossier en acier chromé avec un coussin accouplé pour angle droite ou gauche.
 D Mehrpreis fuer verchromtem Stahl Rücken mit kombiniertem Kissen für rechte-Ecke oder links-Ecke.
 S Suplemento para el respaldo en acero cromado incluyendo cojín, para el rincón derecho o izquierdo.

cm. 58 x 32 x h 47 • mt. 0.85
 in. 22³/₈ x 12³/₈ x h 18³/₈ • yd. 0.95

COM	441,00
L	458,00
T	478,00
S	495,00
Z	515,00
K	533,00
PS	623,00
PF	686,00
PX	826,00
PA	930,00



KEEN00SCHIVER

I Supplemento per schienale in acciaio verniciato con relativo cuscino accoppiato per angolo destro o sinistro.
 E Extra charge for varnished back with its relative back cushion matching for angle element right or left.
 F Supplément pour dossier en acier verni avec un coussin accouplé pour angle droite ou gauche.
 D Mehrpreis fuer lackierten Stahl Rücken mit kombiniertem Kissen für rechte-Ecke oder links-Ecke.
 S Suplemento para el respaldo en acero pintado incluyendo cojín, para el rincón derecho o izquierdo.

cm. 58 x 32 x h 47 • mt. 0.85
 in. 22³/₈ x 12³/₈ x h 18³/₈ • yd. 0.95

COM	375,00
L	391,00
T	412,00
S	430,00
Z	449,00
K	467,00
PS	557,00
PF	620,00
PX	760,00
PA	864,00

KEEN00SUPCRSE

I Supplemento per basamento cromato per ogni singolo elemento imbottito.
 E Extra charge for chromed base for every single upholstered item.
 F Supplément pour piétement chromé pour chaque single élément rembourré.
 D Mehrpreis fuer verchromtem Gestell fuer jede gepolstert Element.
 S Suplemento para la base cromada de cada elemento tapizado.

266,00

KLUB - Design Mauro Lipparini



Struttura. In legno massello di pioppo (stagionato "naturalmente" per almeno 3 anni) con elementi in pannelli di particelle di legno; giunzioni a incastro con spine cilindriche. Il molleggio è garantito da cinghie elastiche in polipropilene e lattice naturale. L'imbottitura della struttura è ottenuta con lastre di poliuretano espanso indeformabile a densità differenziate (con densità di 30÷35 kg/m³) esente da CFC e ricoperto da ovatta poliestere e vellutino accoppiato.

Cuscini. Cuscini di schienale in piuma canalizzata.

Base. Piedini PVC nero

Rivestimento. Disponibile in tessuto e pelle; sfoderabile solo nella versione in tessuto.

Frame. In solid poplar heartwood ("naturally" seasoned for at least 3 years) with connecting elements in particleboard panel; dap joints with cylindrical dowels. The webbing is secured by elastic polypropylene and natural latex belts. The framework is upholstered with contoured sheets of resilient, CFC-free polyurethane foam with different density of 30÷35 kg/m³ and covered by polyester wadding and bonded plush.

Cushions. The back cushions are feather-filled.

Base. Supports in black PVC.

Covers. Available in fabric or leather; removable covers only for fabric version.



KLUB00POLT130

I Poltrona.

E Armchair.

F Fauteuil.

D Sessel.

S Butaca.



cm. 130 x 102 x h 61.5 – hs 40 • mt. 5.75
in. 51¹/₄ x 40¹/₄ x h 24¹/₄ – hs 15¹/₄ • yd. 6.30

COM	1.904,00
L	2.023,00
T	2.165,00
S	2.282,00
Z	2.425,00
K	2.542,00
PS	3.128,00
PF	3.556,00
PX	4.238,00
PA	4.879,00



KLUB00CENT100

I Elemento centrale.

E Central unit.

F Élément central.

D Zentral Element.

S Módulo central.



cm. 100 x 102 x h 61.5 – hs 40 • mt. 3.30
in. 39³/₈ x 40¹/₄ x h 24¹/₄ – hs 15¹/₄ • yd. 3.60

COM	1.514,00
L	1.582,00
T	1.663,00
S	1.731,00
Z	1.814,00
K	1.882,00
PS	2.266,00
PF	2.511,00
PX	2.939,00
PA	3.323,00



KLUB00DIVA180

I Divano 2 posti cm. 180.

E 2 seater sofa cm. 180.

F Canapé 2 places cm. 180.

D Sofa 2-sitzig cm. 180.

S Sofá de 2 plazas 180.



cm. 180 x 102 x h 61.5 – hs 40 • mt. 6.05
in. 70¹/₄ x 40¹/₄ x h 24¹/₄ – hs 15¹/₄ • yd. 6.60

COM	2.347,00
L	2.472,00
T	2.649,00
S	2.786,00
Z	2.950,00
K	3.087,00
PS	3.746,00
PF	4.223,00
PX	5.049,00
PA	5.790,00



KLUB00D158BDX

I Divano 2 posti cm. 158, con bracciolo destro.

E 2 seater sofa cm. 158, with right arm.

F Canapé 2 places cm. 158, avec accoudoir droit.

D Sofa 2-sitzig cm. 158, mit rechter Armlehne.







S Sofá de 2 plazas 158, con brazo derecho.



cm. 158 x 102 x h 61.5 – hs 40 • mt. 5.20
in. 62¹/₄ x 40¹/₄ x h 24¹/₄ – hs 15¹/₄ • yd. 5.70

COM	2.152,00
L	2.259,00
T	2.387,00
S	2.494,00
Z	2.652,00
K	2.767,00
PS	3.346,00
PF	3.755,00
PX	4.409,00
PA	5.023,00

KLUB - Design Mauro Lipparini

	<p>KLUB00D158BSX</p> <p>I Divano 2 posti cm. 158, con bracciolo sinistro. E 2 seater sofa cm. 158, with left arm. F Canapé 2 places cm. 158, avec accoudoir gauche. D Sofa 2-sitzig cm. 158, mit linker Armlehne. S Sofá de 2 plazas 158, con brazo izquierdo.</p>	<p>COM 2.152,00 L 2.259,00 T 2.387,00 S 2.494,00 Z 2.652,00 K 2.767,00 PS 3.346,00 PF 3.755,00 PX 4.409,00 PA 5.023,00</p>
	<p>KLUB00D164ADX</p> <p>I Divano 2 posti cm. 164, con angolo destro. E 2 seater sofa cm. 164, with right angle. F Canapé 2 places cm. 164, avec angle droit. D Sofa 2-sitzig cm. 164, mit Winkel rechts. S Sofá de 2 plazas 164, con rincón derecho.</p>	<p>COM 2.138,00 L 2.247,00 T 2.378,00 S 2.487,00 Z 2.618,00 K 2.726,00 PS 3.356,00 PF 3.774,00 PX 4.442,00 PA 5.070,00</p>
	<p>KLUB00D164ASX</p> <p>I Divano 2 posti cm. 164, con angolo sinistro. E 2 seater sofa cm. 164, with left angle. F Canapé 2 places cm. 164, avec angle gauche. D Sofa 2-sitzig cm. 164, mit Winkel links. S Sofá de 2 plazas 164, con rincón izquierdo.</p>	<p>COM 2.138,00 L 2.247,00 T 2.378,00 S 2.487,00 Z 2.618,00 K 2.726,00 PS 3.356,00 PF 3.774,00 PX 4.442,00 PA 5.070,00</p>
	<p>KLUB00D186ADX</p> <p>I Divano 2 posti cm. 186, con bracciolo sinistro ed angolo destro. E 2 seater sofa cm. 186, with left arm and right angle. F Canapé 2 places cm. 186, avec accoudoir gauche et angle droit. D Sofa 2-sitzig cm. 186, mit linker Armlehne und Winkel rechts. S Sofá de 2 plazas 186, con brazo izquierdo y rincón derecho.</p>	<p>COM 2.411,00 L 2.538,00 T 2.691,00 S 2.847,00 Z 3.009,00 K 3.143,00 PS 3.833,00 PF 4.319,00 PX 5.096,00 PA 5.826,00</p>
	<p>KLUB00D186ASX</p> <p>I Divano 2 posti cm. 186, con bracciolo destro ed angolo sinistro. E 2 seater sofa cm. 186, with right arm and left angle. F Canapé 2 places cm. 186, avec accoudoir droit et angle gauche. D Sofa 2-sitzig cm. 186, mit rechter Armlehne und Winkel links. S Sofá de 2 plazas 186, con brazo derecho y rincón izquierdo.</p>	<p>COM 2.411,00 L 2.538,00 T 2.691,00 S 2.818,00 Z 2.971,00 K 3.098,00 PS 3.833,00 PF 4.319,00 PX 5.096,00 PA 5.826,00</p>
	<p>KLUB00DIVA210</p> <p>I Divano 2 posti cm. 210. E 2 seater sofa cm. 210. F Canapé 2 places cm. 210. D Sofa 2-sitzig cm. 210. S Sofá de 2 plazas 210.</p>	<p>COM 2.665,00 L 2.841,00 T 3.031,00 S 3.190,00 Z 3.381,00 K 3.539,00 PS 4.348,00 PF 4.921,00 PX 5.839,00 PA 6.699,00</p>

KLUB - Design Mauro Lipparini

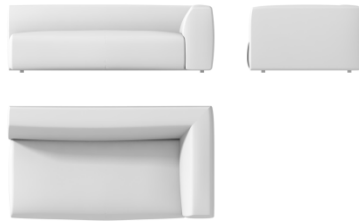

KLUB00D188BDX

I Divano 2 posti cm. 188, con bracciolo destro.
 E 2 seater sofa cm. 188, with right arm.
 F Canapé 2 places cm. 188, avec accoudoir droit.
 D Sofa 2-sitzig cm. 188, mit rechter Armlehne.
 S Sofá de 2 plazas 188, con brazo derecho.

cm. 188 x 102 x h 61.5 – hs 40 • mt. 5.80
 in. 74" x 40"½ x h 24"¼ – hs 15"¾ • yd. 6.35

COM	2.341,00
L	2.462,00
T	2.606,00
S	2.726,00
Z	2.871,00
K	3.024,00
PS	3.716,00
PF	4.175,00
PX	4.909,00
PA	5.597,00



KLUB00D188BSX

I Divano 2 posti cm. 188, con bracciolo sinistro.
 E 2 seater sofa cm. 188, with left arm.
 F Canapé 2 places cm. 188, avec accoudoir gauche.
 D Sofa 2-sitzig cm. 188, mit linker Armlehne.
 S Sofá de 2 plazas 188, con brazo izquierdo.

cm. 188 x 102 x h 61.5 – hs 40 • mt. 5.80
 in. 74" x 40"½ x h 24"¼ – hs 15"¾ • yd. 6.35

COM	2.341,00
L	2.462,00
T	2.606,00
S	2.726,00
Z	2.871,00
K	3.024,00
PS	3.716,00
PF	4.175,00
PX	4.909,00
PA	5.597,00



KLUB00D194ADX

I Divano 2 posti cm. 194, con angolo destro.
 E 2 seater sofa cm. 194, with right angle.
 F Canapé 2 places cm. 194, avec angle droit.
 D Sofa 2-sitzig cm. 194, mit Winkel rechts.
 S Sofá de 2 plazas 194, con rincón derecho.

cm. 194 x 102 x h 61.5 – hs 40 • mt. 5.95
 in. 76"¾ x 40"½ x h 24"¼ – hs 15"¾ • yd. 6.50

COM	2.384,00
L	2.508,00
T	2.654,00
S	2.777,00
Z	2.924,00
K	3.047,00
PS	3.783,00
PF	4.251,00
PX	5.000,00
PA	5.702,00



KLUB00D194ASX

I Divano 2 posti cm. 194, con angolo sinistro.
 E 2 seater sofa cm. 194, with left angle.
 F Canapé 2 places cm. 194, avec angle gauche.
 D Sofa 2-sitzig cm. 194, mit Winkel links.
 S Sofá de 2 plazas 194, con rincón izquierdo.

cm. 194 x 102 x h 61.5 – hs 40 • mt. 5.95
 in. 76"¾ x 40"½ x h 24"¼ – hs 15"¾ • yd. 6.50

COM	2.384,00
L	2.508,00
T	2.654,00
S	2.777,00
Z	2.924,00
K	3.047,00
PS	3.783,00
PF	4.251,00
PX	5.000,00
PA	5.702,00



KLUB00D216ADX

I Divano 2 posti cm. 216, con bracciolo sinistro ed angolo destro.
 E 2 seater sofa cm. 216, with left arm and right angle.
 F Canapé 2 places cm. 216, avec accoudoir gauche et angle droit.
 D Sofa 2-sitzig cm. 216, mit linker Armlehne und Winkel rechts.
 S Sofá de 2 plazas 216, con brazo izquierdo y rincón derecho.

cm. 216 x 102 x h 61.5 – hs 40 • mt. 6.80
 in. 85" x 40"½ x h 24"¼ – hs 15"¾ • yd. 7.45

COM	2.687,00
L	2.827,00
T	2.997,00
S	3.137,00
Z	3.306,00
K	3.447,00
PS	4.288,00
PF	4.823,00
PX	5.681,00
PA	6.485,00



KLUB00D216ASX

I Divano 2 posti cm. 216, con bracciolo destro ed angolo sinistro.
 E 2 seater sofa cm. 216, with right arm and left angle.
 F Canapé 2 places cm. 216, avec accoudoir droit et angle gauche.
 D Sofa 2-sitzig cm. 216, mit rechter Armlehne und Winkel links.
 S Sofá de 2 plazas 216, con brazo derecho y rincón izquierdo.

cm. 216 x 102 x h 61.5 – hs 40 • mt. 6.80
 in. 85" x 40"½ x h 24"¼ – hs 15"¾ • yd. 7.45

COM	2.687,00
L	2.827,00
T	2.997,00
S	3.137,00
Z	3.306,00
K	3.447,00
PS	4.288,00
PF	4.823,00
PX	5.681,00
PA	6.485,00

KLUB - Design Mauro Lipparini



KLUB00DIVA240

I Divano 2 posti cm. 240.
 E 2 seater sofa cm. 240.
 F Canapé 2 places cm. 240.
 D Sofa 2-sitzig cm. 240.
 S Sofá de 2 plazas 240.

cm. 240 x 102 x h 61.5 – hs 40 • mt. 7.50
 in. 94”½ x 40”¼ x h 24”¼ – hs 15”¾ • yd. 8.20

COM	2.890,00
L	3.078,00
T	3.273,00
S	3.437,00
Z	3.632,00
K	3.796,00
PS	4.644,00
PF	5.235,00
PX	6.180,00
PA	7.066,00



KLUB00D218BDX

I Divano 2 posti cm. 218, con bracciolo destro.
 E 2 seater sofa cm. 218, with right arm.
 F Canapé 2 places cm. 218, avec accoudoir droit.
 D Sofa 2-sitzig cm. 218, mit rechter Armlehne.
 S Sofá de 2 plazas 218, con brazo derecho.

cm. 218 x 102 x h 61.5 – hs 40 • mt. 6.50
 in. 85”¾ x 40”¼ x h 24”¼ – hs 15”¾ • yd. 7.10

COM	2.592,00
L	2.733,00
T	2.902,00
S	3.044,00
Z	3.213,00
K	3.354,00
PS	4.076,00
PF	4.585,00
PX	5.398,00
PA	6.161,00



KLUB00D218BSX

I Divano 2 posti cm. 218, con bracciolo sinistro.
 E 2 seater sofa cm. 218, with left arm.
 F Canapé 2 places cm. 218, avec accoudoir gauche.
 D Sofa 2-sitzig cm. 218, mit linker Armlehne.
 S Sofá de 2 plazas 218, con brazo izquierdo.

cm. 218 x 102 x h 61.5 – hs 40 • mt. 6.50
 in. 85”¾ x 40”¼ x h 24”¼ – hs 15”¾ • yd. 7.10

COM	2.592,00
L	2.733,00
T	2.902,00
S	3.044,00
Z	3.213,00
K	3.354,00
PS	4.076,00
PF	4.585,00
PX	5.398,00
PA	6.161,00



KLUB00D224ADX

I Divano 2 posti cm. 224, con angolo destro.
 E 2 seater sofa cm. 224, with right angle.
 F Canapé 2 places cm. 224, avec angle droit.
 D Sofa 2-sitzig cm. 224, mit Winkel rechts.
 S Sofá de 2 plazas 224, con rincón derecho.

cm. 224 x 102 x h 61.5 – hs 40 • mt. 6.60
 in. 88”¾ x 40”¼ x h 24”¼ – hs 15”¾ • yd. 7.20

COM	2.627,00
L	2.763,00
T	2.926,00
S	3.063,00
Z	3.227,00
K	3.363,00
PS	4.201,00
PF	4.718,00
PX	5.548,00
PA	6.324,00



KLUB00D224ASX

I Divano 2 posti cm. 224, con angolo sinistro.
 E 2 seater sofa cm. 224, with left angle.
 F Canapé 2 places cm. 224, avec angle gauche.
 D Sofa 2-sitzig cm. 224, mit Winkel links.
 S Sofá de 2 plazas 224, con rincón izquierdo.

cm. 224 x 102 x h 61.5 – hs 40 • mt. 6.60
 in. 88”¾ x 40”¼ x h 24”¼ – hs 15”¾ • yd. 7.20

COM	2.627,00
L	2.763,00
T	2.926,00
S	3.063,00
Z	3.227,00
K	3.363,00
PS	4.201,00
PF	4.718,00
PX	5.548,00
PA	6.324,00











KLUB00D246ADX

I Divano 2 posti cm. 246, con bracciolo sinistro ed angolo destro.
 E 2 seater sofa cm. 246, with left arm and right angle.
 F Canapé 2 places cm. 246, avec accoudoir gauche et angle droite.
 D Sofa 2-sitzig cm. 246, mit linker Armlehne und Winkel rechts.
 S Sofá de 2 plazas 246, con brazo izquierdo y rincón derecho.

cm. 246 x 102 x h 61.5 – hs 40 • mt. 7.50
 in. 96”¾ x 40”¼ x h 24”¼ – hs 15”¾ • yd. 8.20

COM	3.111,00
L	3.285,00
T	3.451,00
S	3.605,00
Z	3.833,00
K	3.994,00
PS	4.903,00
PF	5.493,00
PX	6.439,00
PA	7.324,00

KLUB - Design Mauro Lipparini

	<p>KLUB00D246ASX</p> <p>I Divano 2 posti cm. 246, con bracciolo destro ed angolo sinistro. E 2 seater sofa cm. 246, with right arm and left angle. F Canapé 2 places cm. 246, avec accoudoir droit et angle gauche. D Sofa 2-sitzig cm. 246, mit rechter Armlehne und Winkel links. S Sofá de 2 plazas 246, con brazo derecho y rincón izquierdo.</p>	COM	3.111,00
		L	3.265,00
	<p>cm. 246 x 102 x h 61.5 – hs 40 • mt. 7.50 in. 96”$\frac{1}{4}$ x 40”$\frac{1}{2}$ x h 24”$\frac{1}{4}$ – hs 15”$\frac{3}{4}$ • yd. 8.20</p>	T	3.451,00
		S	3.605,00
	<p>KLUB00D246ASX</p> <p>I Divano 2 posti cm. 246, con bracciolo destro ed angolo sinistro. E 2 seater sofa cm. 246, with right arm and left angle. F Canapé 2 places cm. 246, avec accoudoir droit et angle gauche. D Sofa 2-sitzig cm. 246, mit rechter Armlehne und Winkel links. S Sofá de 2 plazas 246, con brazo derecho y rincón izquierdo.</p>	Z	3.833,00
		K	3.994,00
	<p>cm. 246 x 102 x h 61.5 – hs 40 • mt. 7.50 in. 96”$\frac{1}{4}$ x 40”$\frac{1}{2}$ x h 24”$\frac{1}{4}$ – hs 15”$\frac{3}{4}$ • yd. 8.20</p>	PS	4.903,00
		PF	5.493,00
	<p>cm. 246 x 102 x h 61.5 – hs 40 • mt. 7.50 in. 96”$\frac{1}{4}$ x 40”$\frac{1}{2}$ x h 24”$\frac{1}{4}$ – hs 15”$\frac{3}{4}$ • yd. 8.20</p>	PX	6.439,00
		PA	7.324,00
	<p>KLUB00D248BDX</p> <p>I Divano 3 posti cm. 248, con bracciolo destro. E 3 seater sofa cm. 248, with right arm. F Canapé 3 places cm. 248, avec accoudoir droit. D Sofa 3-sitzig cm. 248, mit rechter Armlehne. S Sofá de 3 plazas 248, con brazo derecho.</p>	COM	2.965,00
		L	3.113,00
	<p>cm. 248 x 102 x h 61.5 – hs 40 • mt. 7.15 in. 97”$\frac{1}{2}$ x 40”$\frac{1}{2}$ x h 24”$\frac{1}{4}$ – hs 15”$\frac{3}{4}$ • yd. 7.80</p>	T	3.323,00
		S	3.478,00
	<p>cm. 248 x 102 x h 61.5 – hs 40 • mt. 7.15 in. 97”$\frac{1}{2}$ x 40”$\frac{1}{2}$ x h 24”$\frac{1}{4}$ – hs 15”$\frac{3}{4}$ • yd. 7.80</p>	Z	3.663,00
		K	3.817,00
	<p>cm. 248 x 102 x h 61.5 – hs 40 • mt. 7.15 in. 97”$\frac{1}{2}$ x 40”$\frac{1}{2}$ x h 24”$\frac{1}{4}$ – hs 15”$\frac{3}{4}$ • yd. 7.80</p>	PS	4.656,00
		PF	5.219,00
	<p>cm. 248 x 102 x h 61.5 – hs 40 • mt. 7.15 in. 97”$\frac{1}{2}$ x 40”$\frac{1}{2}$ x h 24”$\frac{1}{4}$ – hs 15”$\frac{3}{4}$ • yd. 7.80</p>	PX	6.119,00
		PA	6.965,00
	<p>KLUB00D248BSX</p> <p>I Divano 3 posti cm. 248, con bracciolo sinistro. E 3 seater sofa cm. 248, with left arm. F Canapé 3 places cm. 248, avec accoudoir gauche. D Sofa 3-sitzig cm. 248, mit linker Armlehne. S Sofá de 3 plazas 248, con brazo izquierdo.</p>	COM	2.965,00
		L	3.113,00
	<p>cm. 248 x 102 x h 61.5 – hs 40 • mt. 7.15 in. 97”$\frac{1}{2}$ x 40”$\frac{1}{2}$ x h 24”$\frac{1}{4}$ – hs 15”$\frac{3}{4}$ • yd. 7.80</p>	T	3.323,00
		S	3.478,00
	<p>cm. 248 x 102 x h 61.5 – hs 40 • mt. 7.15 in. 97”$\frac{1}{2}$ x 40”$\frac{1}{2}$ x h 24”$\frac{1}{4}$ – hs 15”$\frac{3}{4}$ • yd. 7.80</p>	Z	3.663,00
		K	3.817,00
	<p>cm. 248 x 102 x h 61.5 – hs 40 • mt. 7.15 in. 97”$\frac{1}{2}$ x 40”$\frac{1}{2}$ x h 24”$\frac{1}{4}$ – hs 15”$\frac{3}{4}$ • yd. 7.80</p>	PS	4.656,00
		PF	5.219,00
	<p>cm. 248 x 102 x h 61.5 – hs 40 • mt. 7.15 in. 97”$\frac{1}{2}$ x 40”$\frac{1}{2}$ x h 24”$\frac{1}{4}$ – hs 15”$\frac{3}{4}$ • yd. 7.80</p>	PX	6.119,00
		PA	6.965,00
	<p>KLUB00D254ADX</p> <p>I Divano 3 posti cm. 254, con angolo destro. E 3 seater sofa cm. 254, with right angle. F Canapé 3 places cm. 254, avec angle droit. D Sofa 3-sitzig cm. 254, mit Winkel rechts. S Sofá de 3 plazas 254, con rincón derecho.</p>	COM	3.020,00
		L	3.169,00
	<p>cm. 254 x 102 x h 61.5 – hs 40 • mt. 7.25 in. 100” x 40”$\frac{1}{2}$ x h 24”$\frac{1}{4}$ – hs 15”$\frac{3}{4}$ • yd. 7.95</p>	T	3.350,00
		S	3.500,00
	<p>cm. 254 x 102 x h 61.5 – hs 40 • mt. 7.25 in. 100” x 40”$\frac{1}{2}$ x h 24”$\frac{1}{4}$ – hs 15”$\frac{3}{4}$ • yd. 7.95</p>	Z	3.679,00
		K	3.830,00
	<p>cm. 254 x 102 x h 61.5 – hs 40 • mt. 7.25 in. 100” x 40”$\frac{1}{2}$ x h 24”$\frac{1}{4}$ – hs 15”$\frac{3}{4}$ • yd. 7.95</p>	PS	4.718,00
		PF	5.286,00
	<p>cm. 254 x 102 x h 61.5 – hs 40 • mt. 7.25 in. 100” x 40”$\frac{1}{2}$ x h 24”$\frac{1}{4}$ – hs 15”$\frac{3}{4}$ • yd. 7.95</p>	PX	6.194,00
		PA	7.046,00
	<p>KLUB00D254ASX</p> <p>I Divano 3 posti cm. 254, con angolo sinistro. E 3 seater sofa cm. 254, with left angle. F Canapé 3 places cm. 254, avec angle gauche. D Sofa 3-sitzig cm. 254, mit Winkel links. S Sofá de 3 plazas 254, con rincón izquierdo.</p>	COM	3.020,00
		L	3.169,00
	<p>cm. 254 x 102 x h 61.5 – hs 40 • mt. 7.25 in. 100” x 40”$\frac{1}{2}$ x h 24”$\frac{1}{4}$ – hs 15”$\frac{3}{4}$ • yd. 7.95</p>	T	3.350,00
		S	3.500,00
	<p>cm. 254 x 102 x h 61.5 – hs 40 • mt. 7.25 in. 100” x 40”$\frac{1}{2}$ x h 24”$\frac{1}{4}$ – hs 15”$\frac{3}{4}$ • yd. 7.95</p>	Z	3.679,00
		K	3.830,00
	<p>cm. 254 x 102 x h 61.5 – hs 40 • mt. 7.25 in. 100” x 40”$\frac{1}{2}$ x h 24”$\frac{1}{4}$ – hs 15”$\frac{3}{4}$ • yd. 7.95</p>	PS	4.718,00
		PF	5.286,00
	<p>cm. 254 x 102 x h 61.5 – hs 40 • mt. 7.25 in. 100” x 40”$\frac{1}{2}$ x h 24”$\frac{1}{4}$ – hs 15”$\frac{3}{4}$ • yd. 7.95</p>	PX	6.194,00
		PA	7.046,00

KLUB - Design Mauro Lipparini



KLUB00D276ADX

I Divano 3 posti cm. 276, con bracciolo sinistro ed angolo destro.
 E 3 seater sofa cm. 276, with left arm and right angle.
 F Canapé 3 places cm. 276, avec accoudoir gauche et angle droit.
 D Sofa 3-sitzig cm. 276, mit linker Armlehne und Winkel rechts.
 S Sofá de 3 plazas 276, con brazo izquierdo y rincón derecho.

cm. 276 x 102 x h 61.5 – hs 40 • mt. 8.15
 in. 108³/₈ x 40³/₈ x h 24³/₄ – hs 15³/₈ • yd. 8.90

COM	3.298,00
L	3.466,00
T	3.668,00
S	3.836,00
Z	4.038,00
K	4.247,00
PS	5.200,00
PF	5.836,00
PX	6.854,00
PA	7.807,00



KLUB00D276ASX

I Divano 3 posti cm. 276, con bracciolo destro ed angolo sinistro.
 E 3 seater sofa cm. 276, with right arm and left angle.
 F Canapé 3 places cm. 276, avec accoudoir droit et angle gauche.
 D Sofa 3-sitzig cm. 276, mit rechter Armlehne und Winkel links.
 S Sofá de 3 plazas 276, con brazo derecho y rincón izquierdo.

cm. 276 x 102 x h 61.5 – hs 40 • mt. 8.15
 in. 108³/₈ x 40³/₈ x h 24³/₄ – hs 15³/₈ • yd. 8.90

COM	3.298,00
L	3.466,00
T	3.668,00
S	3.836,00
Z	4.038,00
K	4.247,00
PS	5.200,00
PF	5.836,00
PX	6.854,00
PA	7.807,00

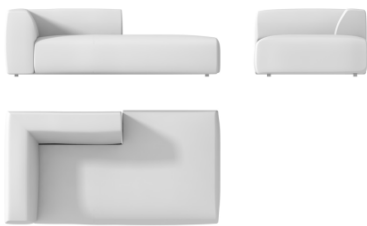

KLUB00CHAISDX

I Chaiselongue destra.
 E Right chaiselongue.
 F Dormeuse droite.
 D Rechte Dormeuse.
 S Chaise longue derecha.

cm. 102 x 195 x h 61.5 – hs 40 • mt. 5.50
 in. 40³/₈ x 76³/₈ x h 24³/₄ – hs 15³/₈ • yd. 6.00

COM	2.272,00
L	2.387,00
T	2.522,00
S	2.636,00
Z	2.773,00
K	2.886,00
PS	3.562,00
PF	4.003,00
PX	4.709,00
PA	5.371,00

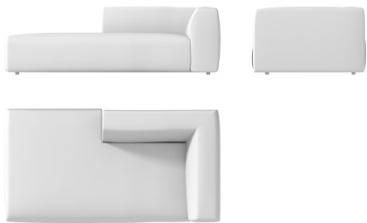

KLUB00CHAIS SX

I Chaiselongue sinistra.
 E Left chaiselongue.
 F Dormeuse gauche.
 D Linke Dormeuse.
 S Chaise longue izquierda.

cm. 102 x 195 x h 61.5 – hs 40 • mt. 5.50
 in. 40³/₈ x 76³/₈ x h 24³/₄ – hs 15³/₈ • yd. 6.00

COM	2.272,00
L	2.387,00
T	2.522,00
S	2.636,00
Z	2.773,00
K	2.886,00
PS	3.562,00
PF	4.003,00
PX	4.709,00
PA	5.371,00

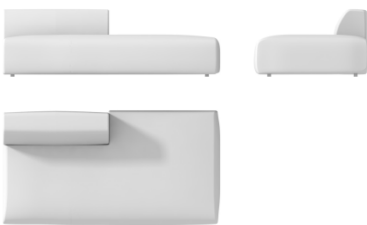

KLUB00PENISDX

I Penisola lineare destra.
 E Right linear chaiselongue.
 F Dormeuse linéaire droite.
 D Rechte lineare Dormeuse.
 S Chaise longue lineal derecha.

cm. 102 x 195 x h 61.5 – hs 40 • mt. 5.20
 in. 40³/₈ x 76³/₈ x h 24³/₄ – hs 15³/₈ • yd. 5.70

COM	2.051,00
L	2.157,00
T	2.286,00
S	2.392,00
Z	2.520,00
K	2.627,00
PS	3.229,00
PF	3.615,00
PX	4.232,00
PA	4.812,00

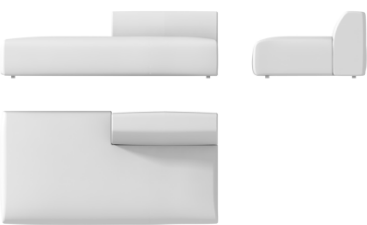

KLUB00PENIS SX

I Penisola lineare sinistra.
 E Left linear chaiselongue.
 F Dormeuse linéaire gauche.
 D Linke lineare Dormeuse.
 S Chaise longue lineal izquierda.

cm. 102 x 195 x h 61.5 – hs 40 • mt. 5.20
 in. 40³/₈ x 76³/₈ x h 24³/₄ – hs 15³/₈ • yd. 5.70

COM	2.051,00
L	2.157,00
T	2.286,00
S	2.392,00
Z	2.520,00
K	2.627,00
PS	3.229,00
PF	3.615,00
PX	4.232,00
PA	4.812,00

KLUB - Design Mauro Lipparini

	<p>KLUB00POUFQUA</p> <p>I Pouf cm. 100X100. E Ottoman cm. 100X100. F Pouf cm. 100X100. D Hocker cm. 100X100. S Pouf cm. 100X100.</p>	<p>COM 1.096,00 L 1.167,00 T 1.251,00 S 1.322,00 Z 1.406,00 K 1.477,00 PS 1.618,00 PF 1.808,00 PX 2.111,00 PA 2.396,00</p>
	<p>KLUB00SCHIE67</p> <p>I Cuscino cm. 67x47. E Cushion cm. 67x47. F Coussin cm. 67x47. D Kissen cm. 67x47. S Cojín cm. 67x47.</p>	<p>COM 210,00 L 229,00 T 250,00 S 268,00 Z 290,00 K 308,00 PS 394,00 PF 462,00 PX 572,00 PA 674,00</p>
	<p>KLUB00SCHIE75</p> <p>I Cuscino cm. 75x47. E Cushion cm. 75x47. F Coussin cm. 75x47. D Kissen cm. 75x47. S Cojín cm. 75x47.</p>	<p>COM 221,00 L 241,00 T 264,00 S 283,00 Z 307,00 K 325,00 PS 421,00 PF 493,00 PX 610,00 PA 719,00</p>
	<p>KLUB00SCHIE82</p> <p>I Cuscino cm. 82x47. E Cushion cm. 82x47. F Coussin cm. 82x47. D Kissen cm. 82x47. S Cojín cm. 82x47.</p>	<p>COM 226,00 L 247,00 T 273,00 S 295,00 Z 320,00 K 342,00 PS 431,00 PF 508,00 PX 631,00 PA 747,00</p>
	<p>KLUB00SCHIE97</p> <p>I Cuscino cm. 97x47. E Cushion cm. 97x47. F Coussin cm. 97x47. D Kissen cm. 97x47. S Cojín cm. 97x47.</p>	<p>COM 242,00 L 267,00 T 297,00 S 322,00 Z 352,00 K 377,00 PS 500,00 PF 594,00 PX 748,00 PA 890,00</p>
	<p>KLUB00SCHFASC</p> <p>I Cuscinetto con fascia cm. 50x50. E Cushion with band cm. 50x50. F Coussin à plate-bande cm. 50x50. D Kissen mit Band cm. 50x50. S Cojín con banda cm. 50x50.</p>	<p>COM 191,00 L 205,00 T 222,00 S 238,00 Z 255,00 K 270,00 PS 352,00 PF 402,00 PX 482,00 PA 556,00</p>

KLUB - Design Mauro Lipparini



KLUB00SCHSAPO

- I Cuscinetto a saponetta cm. 50x50.
- E Cushion knife edge cm. 50x50.
- F Coussin ovale cm. 50x50.
- D Seife Kissen cm. 50x50.
- S Cojín tipo "jabón" cm. 50x50.

cm. 50 x 50 x h 10 • mt. 0.65
 in. 19" x 19" x h 3" • yd. 0.70

COM	187,00
L	201,00
T	217,00
S	231,00
Z	247,00
K	261,00
PS	337,00
PF	383,00
PX	455,00
PA	523,00



Struttura. In legno massello di pioppo (stagionato "naturalmente" per almeno 3 anni) con elementi in multistrato di pioppo; giunzioni a incastro con spine cilindriche. Il molleggio è garantito da cinghie elastiche in polipropilene e lattice naturale. L'imbottitura della struttura è ottenuta con lastre di poliuretano espanso indeformabile a densità differenziate (30÷35 kg/m³) esente da CFC ricoperto da ovatta poliestere e vellutino accoppiato. Nella parte inferiore la base è sempre rivestita in pelle.

Cuscini. Cuscini di seduta divisi in 3 camere orizzontali: le due esterne sono in piuma canalizzata mentre nella centrale c'è una lastra di poliuretano (40 kg/m³). I cuscini di schienale sono completamente in piuma canalizzata. I cuscini di schienale e di seduta sono dotati di bordo a palloncino.

Base. Supporti in tubolare d'acciaio verniciati in finitura champagne con piedino in PVC regolabile.

Rivestimento. Disponibile in tessuto e pelle; sfoderabile solo per i cuscini.

Tavolino. Il piano in marmo giace su un pannello di nobilitato con bordi imbottiti e rivestiti in pelle. Supporti in tubolare d'acciaio verniciati in finitura champagne con piedino in PVC regolabile.

Frame. In solid poplar heartwood ("naturally" seasoned for at least 3 years) with connecting elements in poplar plywood; dap joints with cylindrical dowels. The webbing is secured by elastic polypropylene and natural latex belts. The framework is upholstered with contoured sheets of resilient, CFC-free polyurethane foam (with density of 30÷35 kg/m³) covered by polyester wadding and bonded plush. The lower part of the frame is covered in leather.

Cushions. The seat cushions are subdivided in 3 horizontal units: the two outside units are feather filled while in the central one there is a sheet of polyurethane foam (40 kg/m³). The back cushions are always feather-filled. The seat and back cushions are equipped with piping.

Base. Supports in tubular steel painted with champagne finish with adjustable PVC feet.

Covers. Available in fabric or leather; removable covers only for cushions.

Low tables. The marble top is laying on a melamine coated panel with side upholstered and covered in leather. Supports in tubular steel painted with champagne finish with adjustable PVC feet.

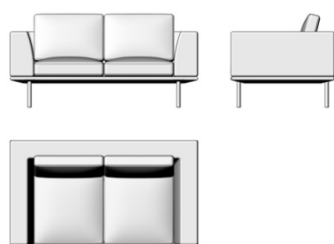

KOI000DIVA172

- I Divano 2 posti cm. 172.
- E 2 seater sofa cm. 172.
- F Canapé 2 places cm. 172.
- D Sofa 2-sitzig cm. 172.
- S Sofá de 2 plazas cm. 172.

cm. 172 x 95 x h 80 – hs 44 • mt. 7.15
in. 67" x 37" x h 31" – hs 17" • yd. 7.81

COM	3.870,00
L	4.010,00
T	4.179,00
S	4.320,00
Z	4.489,00
K	4.629,00
PS	5.124,00
PF	5.630,00
PX	6.440,00
PA	7.199,00

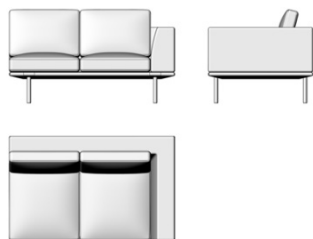

KOI000D150BDX

- I Divano 2 posti con bracciolo destro cm. 150.
- E 2 seater sofa with right arm cm. 150.
- F Canapé 2 places avec accoudoir droit cm. 150.
- D Sofa 2-sitzig mit rechter Armlehne cm. 150.
- S Sofá de 2 plazas con brazo derecho cm. 150.

cm. 150 x 95 x h 80 – hs 44 • mt. 6.40
in. 59" x 37" x h 31" – hs 17" • yd. 7.00

COM	3.592,00
L	3.716,00
T	3.868,00
S	3.992,00
Z	4.144,00
K	4.268,00
PS	4.718,00
PF	5.173,00
PX	5.900,00
PA	6.581,00

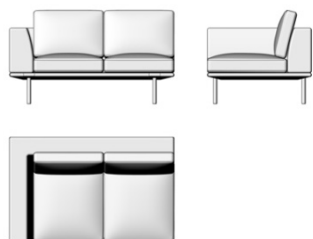

KOI000D150BSX

- I Divano 2 posti con bracciolo sinistro cm. 150.
- E 2 seater sofa with left arm cm. 150.
- F Canapé 2 places avec accoudoir gauche cm. 150.
- D Sofa 2-sitzig mit linker Armlehne cm. 150.
- S Sofá de 2 plazas con brazo izquierdo cm. 150.

cm. 150 x 95 x h 80 – hs 44 • mt. 6.40
in. 59" x 37" x h 31" – hs 17" • yd. 7.00

COM	3.592,00
L	3.716,00
T	3.868,00
S	3.992,00
Z	4.144,00
K	4.268,00
PS	4.718,00
PF	5.173,00
PX	5.900,00
PA	6.581,00

KOI - Design Alessandro Dubini

	<p>KOI000CH150DX</p> <p>I Chaiselongue destra cm. 150. E Right chaiselongue cm. 150. F Dormeuse droite cm. 150. D Rechte Dormeuse cm. 150. S Chaise longue derecha cm. 150.</p>	<p>COM 3.580,00 L 3.714,00 T 3.875,00 S 4.010,00 Z 4.170,00 K 4.304,00 PS 4.782,00 PF 5.266,00 PX 6.042,00 PA 6.768,00</p>
	<p>KOI000CH150SX</p> <p>I Chaiselongue sinistra cm. 150. E Left chaiselongue cm. 150. F Dormeuse gauche cm. 150. D Linke Dormeuse cm. 150. S Chaise longue izquierda cm. 150.</p>	<p>COM 3.580,00 L 3.714,00 T 3.875,00 S 4.010,00 Z 4.170,00 K 4.304,00 PS 4.782,00 PF 5.266,00 PX 6.042,00 PA 6.768,00</p>
	<p>KOI000PE150DX</p> <p>I Penisola lineare destra cm. 150. E Right linear chaiselongue cm. 150. F Dormeuse linéaire droite cm. 150. D Rechte lineare Dormeuse cm. 150. S Chaise longue lineal derecha cm. 150.</p>	<p>COM 3.465,00 L 3.580,00 T 3.717,00 S 3.832,00 Z 3.970,00 K 4.084,00 PS 4.496,00 PF 4.911,00 PX 5.575,00 PA 6.199,00</p>
	<p>KOI000PE150SX</p> <p>I Penisola lineare sinistra cm. 150. E Left linear chaiselongue cm. 150. F Dormeuse linéaire gauche cm. 150. D Linke lineare Dormeuse cm. 150. S Chaise longue lineal izquierda cm. 150.</p>	<p>COM 3.465,00 L 3.580,00 T 3.717,00 S 3.832,00 Z 3.970,00 K 4.084,00 PS 4.496,00 PF 4.911,00 PX 5.575,00 PA 6.199,00</p>
	<p>KOI000DIVA202</p> <p>I Divano 2 posti cm. 202. E 2 seater sofa cm. 202. F Canapé 2 places cm. 202. D Sofa 2-sitzig cm. 202. S Sofá de 2 plazas cm. 202.</p>	<p>COM 4.176,00 L 4.338,00 T 4.533,00 S 4.695,00 Z 4.889,00 K 5.052,00 PS 5.623,00 PF 6.207,00 PX 7.141,00 PA 8.018,00</p>
	<p>KOI000D180BDX</p> <p>I Divano 2 posti con bracciolo destro cm. 180. E 2 seater sofa with right arm cm. 180. F Canapé 2 places avec accoudoir droit cm. 180. D Sofa 2-sitzig mit rechter Armlehne cm. 180. S Sofá de 2 plazas con brazo derecho cm. 180.</p>	<p>COM 3.951,00 L 4.100,00 T 4.280,00 S 4.429,00 Z 4.608,00 K 4.758,00 PS 5.293,00 PF 5.834,00 PX 6.699,00 PA 7.511,00</p>

KOI - Design Alessandro Dubini

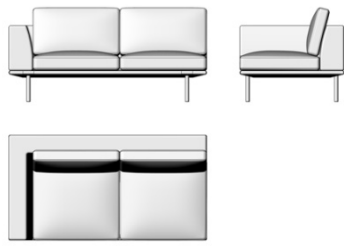

KOI000D180BSX
 I Divano 2 posti con bracciolo sinistro cm. 180.
 E 2 seater sofa with left arm cm. 180.
 F Canapé 2 places avec accoudoir gauche cm. 180.
 D Sofa 2-sitzig mit linker Armlehne cm. 180.
 S Sofá de 2 plazas con brazo izquierdo cm. 180.

cm. 180 x 95 x h 80 – hs 44 • mt. 7.60
 in. 70”% x 37”% x h 31”% – hs 17”% • yd. 8.31

COM	3.951,00
L	4.100,00
T	4.280,00
S	4.429,00
Z	4.608,00
K	4.758,00
PS	5.293,00
PF	5.834,00
PX	6.699,00
PA	7.511,00

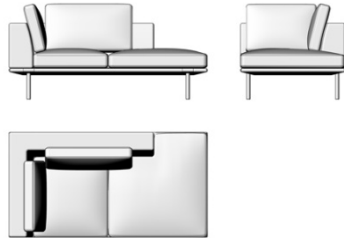

KOI000CH180DX
 I Chaiselongue destra cm. 180.
 E Right chaiselongue cm. 180.
 F Dormeuse droite cm. 180.
 D Rechte Dormeuse cm. 180.
 S Chaise longue derecha cm. 180.

cm. 180 x 95 x h 80 – hs 44 • mt. 7.70
 in. 70”% x 37”% x h 31”% – hs 17”% • yd. 8.42

COM	3.975,00
L	4.126,00
T	4.307,00
S	4.459,00
Z	4.640,00
K	4.792,00
PS	5.325,00
PF	5.870,00
PX	6.742,00
PA	7.559,00

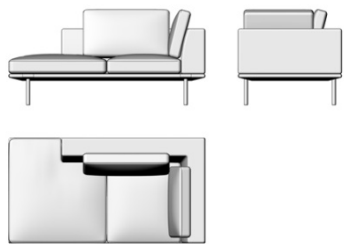

KOI000CH180SX
 I Chaiselongue sinistra cm. 180.
 E Left chaiselongue cm. 180.
 F Dormeuse gauche cm. 180.
 D Linke Dormeuse cm. 180.
 S Chaise longue izquierda cm. 180.

cm. 180 x 95 x h 80 – hs 44 • mt. 7.70
 in. 70”% x 37”% x h 31”% – hs 17”% • yd. 8.42

COM	3.975,00
L	4.126,00
T	4.307,00
S	4.459,00
Z	4.640,00
K	4.792,00
PS	5.325,00
PF	5.870,00
PX	6.742,00
PA	7.559,00

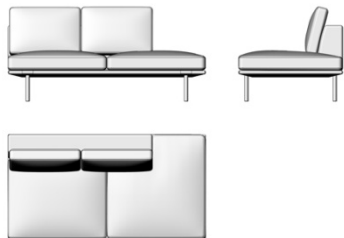

KOI000PE180DX
 I Penisola lineare destra cm. 180.
 E Right linear chaiselongue cm. 180.
 F Dormeuse linéaire droite cm. 180.
 D Rechte lineare Dormeuse cm. 180.
 S Chaise longue lineal derecha cm. 180.

cm. 180 x 95 x h 80 – hs 44 • mt. 6.95
 in. 70”% x 37”% x h 31”% – hs 17”% • yd. 7.60

COM	3.870,00
L	4.006,00
T	4.169,00
S	4.305,00
Z	4.469,00
K	4.605,00
PS	5.093,00
PF	5.587,00
PX	6.376,00
PA	7.115,00

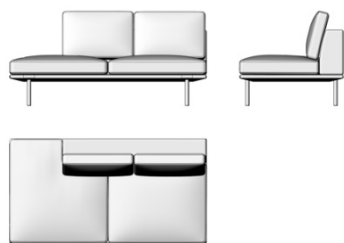

KOI000PE180SX
 I Penisola lineare sinistra cm. 180.
 E Left linear chaiselongue cm. 180.
 F Dormeuse linéaire gauche cm. 180.
 D Linke lineare Dormeuse cm. 180.
 S Chaise longue lineal izquierda cm. 180.

cm. 180 x 95 x h 80 – hs 44 • mt. 6.95
 in. 70”% x 37”% x h 31”% – hs 17”% • yd. 7.60

COM	3.870,00
L	4.006,00
T	4.169,00
S	4.305,00
Z	4.469,00
K	4.605,00
PS	5.093,00
PF	5.587,00
PX	6.376,00
PA	7.115,00



KOI000DIVA232
 I Divano 3 posti cm. 232.
 E 3 seater sofa cm. 232.
 F Canapé 3 places cm. 232.
 D Sofa 3-sitzig cm. 232.
 S Sofá de 3 plazas cm. 232.

cm. 232 x 95 x h 80 – hs 44 • mt. 9.15
 in. 91”% x 37”% x h 31”% – hs 17”% • yd. 10.00

COM	4.705,00
L	4.885,00
T	5.101,00
S	5.280,00
Z	5.495,00
K	5.675,00
PS	6.315,00
PF	6.964,00
PX	8.002,00
PA	8.975,00

KOI - Design Alessandro Dubini

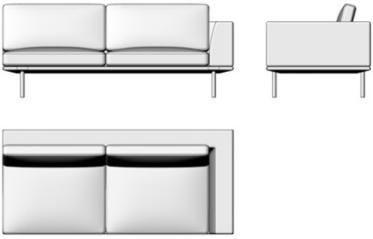
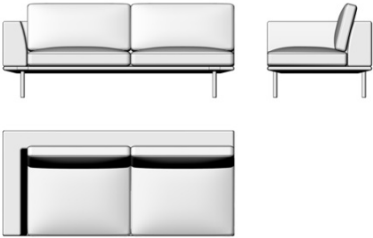
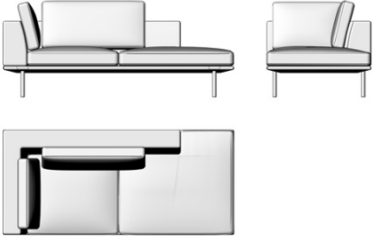
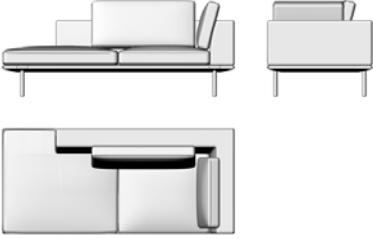
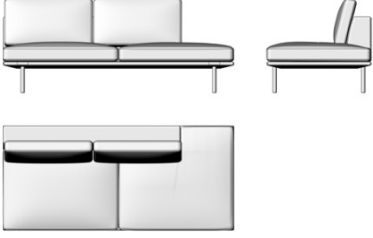
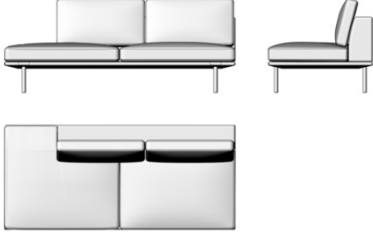
	<p>KOI000D210BDX</p> <p>I Divano 3 posti con bracciolo destro cm. 210. E 3 seater sofa with right arm cm. 210. F Canapé 3 places avec accoudoir droit cm. 210. D Sofa 3-sitzig mit rechter Armlehne cm. 210. S Sofá de 3 plazas con brazo derecho cm. 210.</p>	<p>COM 4.479,00 L 4.653,00 T 4.861,00 S 5.034,00 Z 5.242,00 K 5.415,00 PS 6.023,00 PF 6.647,00 PX 7.643,00 PA 8.578,00</p>
<p>cm. 210 x 95 x h 80 – hs 44 • mt. 8.80 in. 82”% x 37”% x h 31”% – hs 17”% • yd. 9.62</p>		
	<p>KOI000D210BSX</p> <p>I Divano 3 posti con bracciolo sinistro cm. 210. E 3 seater sofa with left arm cm. 210. F Canapé 3 places avec accoudoir gauche cm. 210. D Sofa 3-sitzig mit linker Armlehne cm. 210. S Sofá de 3 plazas con brazo izquierdo cm. 210.</p>	<p>COM 4.479,00 L 4.653,00 T 4.861,00 S 5.034,00 Z 5.242,00 K 5.415,00 PS 6.023,00 PF 6.647,00 PX 7.643,00 PA 8.578,00</p>
<p>cm. 210 x 95 x h 80 – hs 44 • mt. 8.80 in. 82”% x 37”% x h 31”% – hs 17”% • yd. 9.62</p>		
	<p>KOI000CH210DX</p> <p>I Chaiselongue destra cm. 210. E Right chaiselongue cm. 210. F Dormeuse droite cm. 210. D Rechte Dormeuse cm. 210. S Chaise longue derecha cm. 210.</p>	<p>COM 4.347,00 L 4.518,00 T 4.723,00 S 4.894,00 Z 5.099,00 K 5.269,00 PS 5.881,00 PF 6.500,00 PX 7.490,00 PA 8.418,00</p>
<p>cm. 210 x 95 x h 80 – hs 44 • mt. 8.70 in. 82”% x 37”% x h 31”% – hs 17”% • yd. 9.51</p>		
	<p>KOI000CH210SX</p> <p>I Chaiselongue Sinistra cm. 210. E Left chaiselongue cm. 210. F Dormeuse gauche cm. 210. D Linke Dormeuse cm. 210. S Chaise longue izquierda cm. 210.</p>	<p>COM 4.347,00 L 4.518,00 T 4.723,00 S 4.894,00 Z 5.099,00 K 5.269,00 PS 5.881,00 PF 6.500,00 PX 7.490,00 PA 8.418,00</p>
<p>cm. 210 x 95 x h 80 – hs 44 • mt. 8.70 in. 82”% x 37”% x h 31”% – hs 17”% • yd. 9.51</p>		
	<p>KOI000PE210DX</p> <p>I Penisola lineare destra cm. 210. E Right linear chaiselongue cm. 210. F Dormeuse linéaire droite cm. 210. D Rechte lineare Dormeuse cm. 210. S Chaise longue lineal derecha cm. 210.</p>	<p>COM 4.247,00 L 4.398,00 T 4.579,00 S 4.731,00 Z 4.913,00 K 5.065,00 PS 5.597,00 PF 6.142,00 PX 7.014,00 PA 7.832,00</p>
<p>cm. 210 x 95 x h 80 – hs 44 • mt. 7.70 in. 82”% x 37”% x h 31”% – hs 17”% • yd. 8.42</p>		
	<p>KOI000PE210SX</p> <p>I Penisola lineare sinistra cm. 210. E Left linear chaiselongue cm. 210. F Dormeuse linéaire gauche cm. 210. D Linke lineare Dormeuse cm. 210. S Chaise longue lineal izquierda cm. 210.</p>	<p>COM 4.247,00 L 4.398,00 T 4.579,00 S 4.731,00 Z 4.913,00 K 5.065,00 PS 5.597,00 PF 6.142,00 PX 7.014,00 PA 7.832,00</p>
<p>cm. 210 x 95 x h 80 – hs 44 • mt. 7.70 in. 82”% x 37”% x h 31”% – hs 17”% • yd. 8.42</p>		

KOI - Design Alessandro Dubini

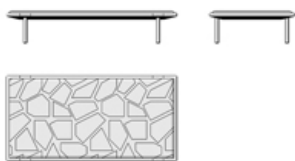

KOI000TA160MD

I Tavolino cm. 160x80 in marmo Dover White.
 E Coffee table cm. 160x80 in marble Dover White.
 F Table basse cm. 160x80 in marbre Dover White.
 D Tisch cm. 160x80 in Marmor Dover White.
 S Mesa centro cm. 160x80 in mármol Dover White.

3.557,00

cm. 160 x 80 x h 30
 in. 63" x 31"½ x h 11"¾

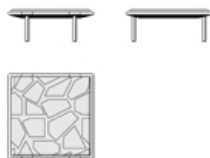

KOI000TA080MD

I Tavolino cm. 80x80 in marmo Dover White.
 E Coffee table cm. 80x80 in marble Dover White.
 F Table basse cm. 80x80 in marbre Dover White.
 D Tisch cm. 80x80 in Marmor Dover White.
 S Mesa centro cm. 80x80 in mármol Dover White.

2.453,00

cm. 80 x 80 x h 30
 in. 31"½ x 31"½ x h 11"¾

KRISTALL - Design Mauro Lipparini



Struttura. Lo schienale e i braccioli sono in legno massello di pioppo (stagionato "naturalmente" per almeno 3 anni) con elementi in pannelli di particelle di legno; giunzioni a incastro con spine cilindriche. L'imbottitura dei braccioli e dello schienale è ottenuta con lastre di poliuretano espanso indeformabile con densità di 75 kg/m³ esente da CFC ricoperto da ovatta poliestere e vellutino accoppiato. Alla struttura è fissato uno schienale d'acciaio disponibile cromato o verniciato a polveri epossidiche in colore RAL a scelta.

Cuscini. Cuscini di seduta disponibili in due varianti: a) in poliuretano espanso a densità differenziate (con densità di 30÷35 kg/m³) ed esente da CFC; b) in poliuretano espanso a densità differenziate (con densità di 30÷35 kg/m³) ed esente da CFC e in piuma nella parte superiore e frontale. I cuscini di schienale sono completamente in piuma canalizzata.

Base. Basamento in tubolare d'acciaio al quale sono fissate le cinghie elastiche in polipropilene e lattice naturale che garantiscono il molleggio. Sullo stesso sono fissate anche delle cinghie di cuoio con pura funzione estetica. E' disponibile cromato o verniciato a polveri epossidiche in colore RAL a scelta.

Rivestimento. Disponibile in tessuto e pelle; sfoderabile solo i cuscini.

Tavolino. Il piano è disponibile in pannello nobilitato rivestito in cuoio o in cristallo supersilver verniciato bianco e temperato. Basamento in tubolare d'acciaio cromato o verniciato a polveri epossidiche in colore RAL a scelta.

Frame. The backrest and the armrests are in solid poplar heartwood ("naturally" seasoned for at least 3 years) with connecting elements in particleboard panel; dap joints with cylindrical dowels. The framework is upholstered with contoured sheets of resilient, CFC-free polyurethane foam with density of 75 kg/m³ covered by polyester wadding and bonded plush. A back support in steel is fixed to the frame; it is available chromed or epoxy powder painted in RAL colors of your choice.

Cushions. The seat cushions are in two versions: a) CFC-free polyurethane foam with different density of 30÷35 kg/m³; b) CFC-free polyurethane foam with different density of 30÷35 kg/m³ and feather in the upper and front part of the cushion. The back cushions are feather-filled.

Base. Base in tubular steel to which are fixed elastic polypropylene and natural latex belts that grant the webbing. On the base there are fixed as well some saddle leather stripes for aesthetic reason only. It is available chromed or epoxy powder painted in RAL colors of your choice.

Covers. Available in fabric or leather; removable covers only for cushions.

Low tables. The top is available in melamine coated panel covered in saddle leather or in tempered supersilver glass white painted underneath. The base is in tubular steel available chromed or epoxy powder painted in RAL colors of your choice.



I Poltrona cm. 112 con base verniciata e cuscino di seduta in piuma (PI) o poliuretano (GO).
E Armchair cm. 112 with painted base and feather (PI) or polyurethane (GO) seat cushion.
F Fauteuil cm. 112 avec pied verni et coussin de l'assise en plume (PI) ou en poliuretano (GO).
D Sessel cm. 112 mit lackiertem Fuss und Daunen (PI) oder Polyurethan (GO) Sitzkissen.
S Butaca cm. 112 con base cromata y cojín de asiento de pluma (PI) o de poliuretano (GO).

cm. 112 x 100 x h 85 – hs 39 • mt. 5.20
 in. 44" x 39" x h 33" – hs 15" • yd. 5.70

	KRISTAPO112PI PI	KRISTAPO112GO GO
COM	3.223,00	COM 3.247,00
L	3.329,00	L 3.354,00
T	3.458,00	T 3.481,00
S	3.564,00	S 3.589,00
Z	3.693,00	Z 3.716,00
K	3.799,00	K 3.823,00
PS	4.436,00	PS 4.460,00
PF	4.813,00	PF 4.837,00
PX	5.640,00	PX 5.664,00
PA	6.263,00	PA 6.288,00



I Poltrona cm. 128 con base verniciata e cuscino di seduta in piuma (PI) o poliuretano (GO).
E Armchair cm. 128 with painted base and feather (PI) or polyurethane (GO) seat cushion.
F Fauteuil cm. 128 avec pied verni et coussin de l'assise en plume (PI) ou en poliuretano (GO).
D Sessel cm. 128 mit lackiertem Fuss und Daunen (PI) oder Polyurethan (GO) Sitzkissen.
S Butaca cm. 128 con base cromata y cojín de asiento de pluma (PI) o de poliuretano (GO).

cm. 128 x 100 x h 85 – hs 39 • mt. 5.80
 in. 50" x 39" x h 33" – hs 15" • yd. 6.35

	KRISTAPO128PI PI	KRISTAPO128GO GO
COM	3.289,00	COM 3.318,00
L	3.409,00	L 3.438,00
T	3.555,00	T 3.582,00
S	3.674,00	S 3.703,00
Z	3.819,00	Z 3.847,00
K	3.940,00	K 3.968,00
PS	4.612,00	PS 4.641,00
PF	5.036,00	PF 5.063,00
PX	5.962,00	PX 5.989,00
PA	6.660,00	PA 6.688,00

KRISTALL - Design Mauro Lipparini



I Divano 2 posti cm. 180 con base verniciata e cuscini di seduta in piuma (PI).
 E 2 seater sofa cm. 180 with painted base and feather (PI) seat cushions.
 F Canapé 2 places cm. 180 avec pied verni et coussins de l'assise en plume (PI).
 D Sofa 2-sitzig cm. 180 mit lackiertem Fuss und Daunen (PI) Sitzkissen.
 S Sofá de 2 plazas cm. 180 con base pintada y cojines de asiento de pluma (PI).

cm. 180 x 100 x h 85 – hs 39 • mt. 8.30
 in. 70³/₈ x 39³/₈ x h 33³/₈ – hs 15³/₈ • yd. 9.10

KRISTADI180PI	
PI	
COM	4.245,00
L	4.415,00
T	4.620,00
S	4.790,00
Z	4.993,00
K	5.164,00
PS	6.054,00
PF	6.654,00
PX	7.956,00
PA	8.943,00



I Divano 2 posti cm. 180 con base verniciata e cuscini di seduta in poliuretano (GO).
 E 2 seater sofa cm. 180 with painted base and polyurethane (GO) seat cushions.
 F Canapé 2 places cm. 180 avec pied verni et coussins de l'assise en poliuretano (GO).
 D Sofa 2-sitzig cm. 180 mit lackiertem Fuss und Polyurethan (GO) Sitzkissen.
 S Sofá de 2 plazas cm. 180 con base pintada y cojines de asiento de poliuretano (GO).

cm. 180 x 100 x h 85 – hs 39 • mt. 8.30
 in. 70³/₈ x 39³/₈ x h 33³/₈ – hs 15³/₈ • yd. 9.10

KRISTADI180GO	
GO	
COM	3.924,00
L	4.094,00
T	4.299,00
S	4.469,00
Z	4.674,00
K	4.844,00
PS	5.734,00
PF	6.333,00
PX	7.635,00
PA	8.623,00

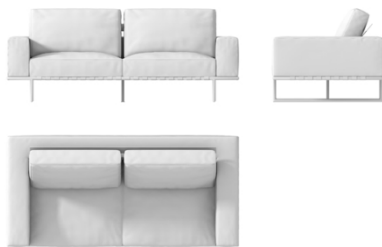

I Divano 2 posti cm. 210 con base verniciata e cuscini di seduta in piuma (PI) o poliuretano (GO).
 E 2 seater sofa cm. 210 with painted base and feather (PI) or polyurethane (GO) seat cushions.
 F Canapé 2 places cm. 210 avec pied verni et coussins de l'assise en plume (PI) ou en poliuretano (GO).
 D Sofa 2-sitzig cm. 210 mit lackiertem Fuss und Daunen (PI) oder Polyurethan (GO) Sitzkissen.
 S Sofá de 2 plazas cm. 210 con base pintada y cojines de asiento de pluma (PI) o de poliuretano (GO).

cm. 210 x 100 x h 85 – hs 39 • mt. 9.50
 in. 82³/₈ x 39³/₈ x h 33³/₈ – hs 15³/₈ • yd. 10.40

KRISTADI210PI		KRISTADI210GO	
PI		GO	
COM	4.585,00	COM	4.336,00
L	4.780,00	L	4.532,00
T	5.014,00	T	4.767,00
S	5.210,00	S	4.962,00
Z	5.445,00	Z	5.196,00
K	5.639,00	K	5.391,00
PS	6.605,00	PS	6.358,00
PF	7.291,00	PF	7.043,00
PX	8.784,00	PX	8.537,00
PA	9.915,00	PA	9.668,00

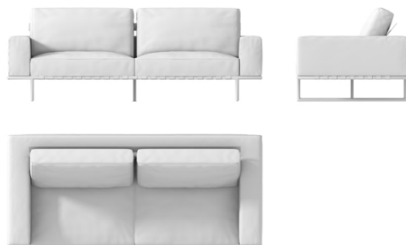

I Divano 3 posti con base verniciata e cuscini di seduta in piuma (PI) o poliuretano (GO).
 E 3 seater sofa with painted base and feather (PI) or polyurethane (GO) seat cushions.
 F Canapé 3 places avec pied verni et coussins de l'assise en plume (PI) ou en poliuretano (GO).
 D Sofa 3-sitzig mit lackiertem Fuss und Daunen (PI) oder Polyurethan (GO) Sitzkissen.
 S Sofá de 3 plazas con base pintada y cojines de asiento de pluma (PI) o de poliuretano (GO).

cm. 240 x 100 x h 85 – hs 39 • mt. 10.80
 in. 94³/₈ x 39³/₈ x h 33³/₈ – hs 15³/₈ • yd. 11.80

KRISTADI240PI		KRISTADI240GO	
PI		GO	
COM	4.964,00	COM	4.707,00
L	5.186,00	L	4.931,00
T	5.454,00	T	5.197,00
S	5.676,00	S	5.420,00
Z	5.943,00	Z	5.687,00
K	6.166,00	K	5.909,00
PS	7.214,00	PS	6.958,00
PF	7.995,00	PF	7.739,00
PX	9.693,00	PX	9.437,00
PA	10.981,00	PA	10.724,00

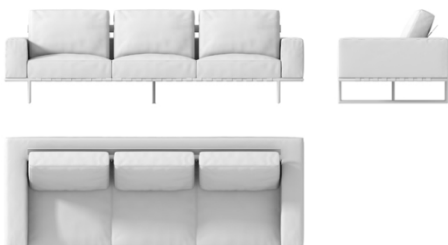

I Divano 4 posti con base verniciata e cuscini di seduta in piuma (PI) o poliuretano (GO).
 E 4 seater sofa with painted base and feather (PI) or polyurethane (GO) seat cushions.
 F Canapé 4 places avec pied verni et coussins de l'assise en plume (PI) ou en poliuretano (GO).
 D Sofa 4-sitzig mit lackiertem Fuss und Daunen (PI) oder Polyurethan (GO) Sitzkissen.
 S Sofá de 4 plazas con base pintada y cojines de asiento de pluma (PI) o de poliuretano (GO).

cm. 270 x 100 x h 85 – hs 39 • mt. 12.10
 in. 106³/₈ x 39³/₈ x h 33³/₈ – hs 15³/₈ • yd. 13.25

KRISTADI270PI		KRISTADI270GO	
PI		GO	
COM	5.660,00	COM	5.374,00
L	5.910,00	L	5.624,00
T	6.210,00	T	5.924,00
S	6.459,00	S	6.173,00
Z	6.759,00	Z	6.473,00
K	7.009,00	K	6.723,00
PS	8.202,00	PS	8.134,00
PF	9.079,00	PF	8.793,00
PX	10.995,00	PX	10.709,00
PA	12.443,00	PA	12.157,00

KRISTALL - Design Mauro Lipparini



I Pouff cm. 85x70 con base verniciata e cuscino di seduta in piuma (PI) o poliuretano (GO).
E Ottoman cm. 85x70 with painted base and feather (PI) or polyurethane (GO) seat cushion.
F Pouf cm. 85x70 avec pied verni et coussin de l'assise en plume (PI) ou en poliuretano (GO).
D Hocker cm. 85x70 mit lackiertem Fuss und Daunen (PI) oder Polyurethan (GO) Sitzkissen.
S Pouf cm. 85x70 con base pintada y cojín de asiento de pluma (PI) o de poliuretano (GO).

cm. 85 x 70 x h 39 – hs 39 • mt. 1.80
 in. 33¹/₂ x 27¹/₂ x h 15³/₈ – hs 15³/₈ • yd. 1.95

	KRISTAPOU70PI		KRISTAPOU70GO
COM	1.332,00	COM	1.279,00
L	1.368,00	L	1.315,00
T	1.412,00	T	1.360,00
S	1.448,00	S	1.396,00
Z	1.491,00	Z	1.439,00
K	1.529,00	K	1.475,00
PS	1.693,00	PS	1.641,00
PF	1.821,00	PF	1.769,00
PX	2.103,00	PX	2.051,00
PA	2.314,00	PA	2.262,00



I Pouff cm. 100x100 con base verniciata e cuscino di seduta in piuma (PI) o poliuretano (GO).
E Ottoman cm. 100x100 with painted base and feather (PI) or polyurethane (GO) seat cushion.
F Pouf cm. 100x100 avec pied verni et coussin de l'assise en plume (PI) ou en poliuretano (GO).
D Hocker cm. 100x100 mit lackiertem Fuss und Daunen (PI) oder Polyurethan (GO) Sitzkissen.
S Pouf cm. 100x100 con base pintada y cojín de asiento de pluma (PI) o de poliuretano (GO).

cm. 100 x 100 x h 39 – hs 39 • mt. 2.20
 in. 39³/₈ x 39³/₈ x h 15³/₈ – hs 15³/₈ • yd. 2.40

	KRISTAPOU10PI		KRISTAPOU10GO
COM	1.619,00	COM	1.553,00
L	1.664,00	L	1.599,00
T	1.719,00	T	1.653,00
S	1.764,00	S	1.698,00
Z	1.819,00	Z	1.753,00
K	1.864,00	K	1.798,00
PS	2.059,00	PS	1.993,00
PF	2.219,00	PF	2.153,00
PX	2.565,00	PX	2.499,00
PA	2.827,00	PA	2.761,00



I Pouff cm. 180x100 con base verniciata e cuscini di seduta in piuma (PI).
E Ottoman cm. 180x100 with painted base and feather (PI) seat cushions.
F Pouf cm. 180x100 avec pied verni et coussins de l'assise en plume (PI).
D Hocker cm. 180x100 mit lackiertem Fuss und Daunen (PI) Sitzkissen.
S Pouf cm. 180x100 con base pintada y cojín de asiento de pluma (PI).

cm. 180 x 100 x h 39 – hs 39 • mt. 4.30
 in. 70³/₈ x 39³/₈ x h 15³/₈ – hs 15³/₈ • yd. 4.70

	KRISTAPOU18PI
COM	3.110,00
L	3.200,00
T	3.309,00
S	3.401,00
Z	3.510,00
K	3.601,00
PS	3.997,00
PF	4.318,00
PX	5.019,00
PA	5.549,00

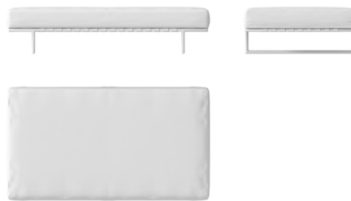

I Pouff cm. 180x100 con base verniciata e cuscini di seduta in poliuretano (GO).
E Ottoman cm. 180x100 with painted base and polyurethane (GO) seat cushions.
F Pouf cm. 180x100 avec pied verni et coussins de l'assise en poliuretano (GO).
D Hocker cm. 180x100 mit lackiertem Fuss und Polyurethan (GO) Sitzkissen.
S Pouf cm. 180x100 con base pintada y cojín de asiento de poliuretano (GO).

cm. 180 x 100 x h 39 – hs 39 • mt. 4.30
 in. 70³/₈ x 39³/₈ x h 15³/₈ – hs 15³/₈ • yd. 4.70

	KRISTAPOU18GO
COM	2.025,00
L	2.114,00
T	2.220,00
S	2.308,00
Z	2.414,00
K	2.503,00
PS	2.889,00
PF	3.200,00
PX	3.882,00
PA	4.396,00

KRISTASUPCRSE

I Supplemento per basamento cromato per ogni singolo elemento imbottito.
E Extra charge for chromed base for every single upholstered item.
F Supplément pour piétement chromé pour chaque single élément rembourré.
D Mehrpreis fuer verchromtem Gestell fuer jede gepolstert Element.
S Suplemento para la base cromada de cada elemento tapizado.

334,00

KRISTALL - Design Mauro Lipparini

I Tavolino in cristallo supersilver verniciato bianco e temperato (CR) oppure cuoio (CU) cm. 100x100 con piedi verniciati.
 E Coffee table in supersilver tempered glass white varnished (CR) or saddle leather (CU) cm. 100x100 with painted legs.
 F Table basse en cristal supersilver trempé et verni blanc (CR) ou cuir (CU) cm. 100x100 avec pied verni.
 D Tisch mit gehärtetem und supersilver weiss lackiert Glas (CR) oder in Rindleder (CU) cm. 100x100 mit lackiertem Fuss.
 S Mesa centro de cristal templado supersilver pintado blanco (CR) o bien en en cuero (CU) cm. 100x100 con base pintada.

cm. 100 x 100 x h 23
 in. 39³/₈ x 39³/₈ x h 9"

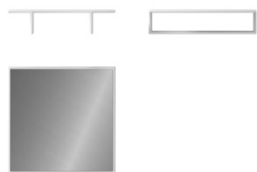

KRISTAT1010CR

1.491,00



KRISTAT1010CU

CV 1.819,00
 CF 1.647,00
 CS 1.431,00

I Tavolino in cristallo supersilver verniciato bianco e temperato (CR) oppure cuoio (CU) cm. 140x70 con piedi verniciati.
 E Coffee table in supersilver tempered glass white varnished (CR) or saddle leather (CU) cm. 140x70 with painted legs.
 F Table basse en cristal supersilver trempé et verni blanc (CR) ou cuir (CU) cm. 140x70 avec pied verni.
 D Tisch mit gehärtetem und supersilver weiss lackiert Glas (CR) oder in Rindleder (CU) cm. 140x70 mit lackiertem Fuss.
 S Mesa centro de cristal templado supersilver pintado blanco (CR) o bien en en cuero (CU) cm. 140x70 con base pintada.

cm. 140 x 70 x h 23
 in. 55¹/₂ x 27¹/₂ x h 9"



KRISTAT1470CR

1.503,00



KRISTAT1470CU

CV 1.843,00
 CF 1.670,00
 CS 1.454,00

I Tavolino in cristallo supersilver verniciato bianco e temperato (CR) oppure cuoio (CU) cm. 180x100 con piedi verniciati.
 E Coffee table in supersilver tempered glass white varnished (CR) or saddle leather (CU) cm. 180x100 with painted legs.
 F Table basse en cristal supersilver trempé et verni blanc (CR) ou cuir (CU) cm. 180x100 avec pied verni.
 D Tisch mit gehärtetem und supersilver weiss lackiert Glas (CR) oder in Rindleder (CU) cm. 180x100 mit lackiertem Fuss.
 S Mesa centro de cristal templado supersilver pintado blanco (CR) o bien en en cuero (CU) cm. 180x100 con base pintada.

cm. 180 x 100 x h 23
 in. 70³/₈ x 39³/₈ x h 9"



KRISTAT1810CR

1.851,00



KRISTAT1810CU

CV 2.250,00
 CF 2.004,00
 CS 1.697,00

KRISTASUPCRTA

I Supplemento per basamento cromato per ogni singolo tavolino.
 E Extra charge for chromed base for every single coffee table.
 F Supplément pour piétement chromé pour chaque single table basse.
 D Mehrpreis fuer verchromtem Gestell fuer jede Tisch.
 S Suplemento para la base cromada de cada mesa centro.

173,00

KUBICO - Design Mauro Lipparini



Struttura. I pouf hanno una struttura in legno massello di pioppo (stagionato "naturalmente" per almeno 3 anni) con elementi in multistrato di pioppo; giunzioni a incastro con spine cilindriche. Il molleggio è garantito da cinghie elastiche in polipropilene e lattice naturale. L'imbottitura della struttura è ottenuta con lastre di poliuretano espanso indeformabile con densità di 45 kg/m³ esente da CFC ricoperto da ovatta poliestere e vellutino accoppiato.

Base. Base in tubolare d'acciaio disponibile cromata, bronzata o verniciata a polveri epossidiche in colore RAL a scelta.

Rivestimento. Disponibile in tessuto e pelle; sfoderabile solo la versione in tessuto.

Tavolino. Base in tubolare d'acciaio disponibile cromata, bronzata o verniciata a polveri epossidiche in colore RAL a scelta. Il piano è disponibile: a) in marmo; b) in cristallo fumé temperato; c) in pannello nobilitato rivestito in cuoio.

Frame. The ottomans have a frame in solid poplar heartwood ("naturally" seasoned for at least 3 years) with connecting elements in poplar plywood; dap joints with cylindrical dowels. The webbing is secured by elastic polypropylene and natural latex belts. The framework is upholstered with contoured sheets of resilient, CFC-free polyurethane foam with density of 45 kg/m³ covered by polyester wadding and bonded plush.

Base. Base in tubular steel chromed, bronzed or epoxy powder painted in RAL colors of your choice.

Covers. Available in fabric or leather; removable covers only for fabric version.

Low tables. Base in tubular steel chromed, bronzed or epoxy powder painted in RAL colors of your choice. The top is available: a) marble; b) smoke tempered glass; c) in melamine coated panel covered in saddle leather.

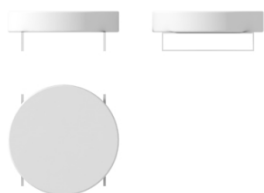

KUBICOPOUTOND

- I Pouf Ø 100 cm con piedi verniciati.
- E Ottoman Ø 100 cm with painted legs.
- F Pouf Ø 100 cm avec pied verni.
- D Hocker Ø 100 cm mit lackiertem Fuss.
- S Pouf Ø 100 cm con patas pintadas.

cm. 100 x 100 x h 36 – hs 36 • mt. 1.65
in. 39" x 39" x h 14" – hs 14" • yd. 1.80

COM	1.029,00
L	1.063,00
T	1.103,00
S	1.137,00
Z	1.177,00
K	1.211,00
PS	1.423,00
PF	1.544,00
PX	1.803,00
PA	1.999,00



KUBICOPOUTOSP

- I Pouf Ø 100 cm senza piedini.
- E Ottoman Ø 100 cm without legs.
- F Pouf Ø 100 cm sans pied.
- D Hocker Ø 100 cm ohne Fuss.
- S Pouf Ø 100 cm sin patas.

cm. 100 x 100 x h 20 – hs 20 • mt. 1.65
in. 39" x 39" x h 7" – hs 7" • yd. 1.80

COM	740,00
L	774,00
T	815,00
S	849,00
Z	889,00
K	923,00
PS	1.502,00
PF	1.244,00
PX	1.030,00
PA	1.700,00



KUBICOPOU4040

- I Pouf cm. 42x42 con piedi verniciati.
- E Ottoman cm. 42x42 with painted legs.
- F Pouf cm. 42x42 avec pied verni.
- D Hocker cm. 42x42 mit lackiertem Fuss.
- S Pouf cm. 42x42 con patas pintadas.

cm. 42 x 42 x h 38 – hs 38 • mt. 0.70
in. 16" x 16" x h 15" – hs 15" • yd. 0.75

COM	628,00
L	643,00
T	660,00
S	675,00
Z	692,00
K	707,00
PS	816,00
PF	867,00
PX	991,00
PA	1.079,00

KUBICO - Design Mauro Lipparini



KUBICOPOUQ100

I Pouf cm. 100x100 con piedi verniciati.
 E Ottoman cm. 100x100 with painted legs.
 F Pouf cm. 100x100 avec pied verni.
 D Hocker cm. 100x100 mit lackiertem Fuss.
 S Pouf cuadrado cm. 100x100 con patas pintadas.

cm. 100 x 100 x h 36 – hs 36 • mt. 1.55
 in. 39”% x 39”% x h 14”% – hs 14”% • yd. 1.70

COM	1.032,00
L	1.064,00
T	1.101,00
S	1.133,00
Z	1.171,00
K	1.202,00
PS	1.410,00
PF	1.524,00
PX	1.772,00
PA	1.959,00



KUBICOPOUQUSP

I Pouf cm. 100x100 senza piedini.
 E Ottoman cm. 100x100 without legs.
 F Pouf cm. 100x100 sans pied.
 D Hocker cm. 100x100 ohne Fuss.
 S Pouf cuadrado cm. 100x100 sin patas.

cm. 100 x 100 x h 20 – hs 20 • mt. 1.55
 in. 39”% x 39”% x h 7”% – hs 7”% • yd. 1.70

COM	715,00
L	747,00
T	785,00
S	817,00
Z	855,00
K	887,00
PS	1.444,00
PF	1.197,00
PX	995,00
PA	1.632,00

I Tavolino cm. 100x100 con piedi verniciati. Disponibile in: cristallo fumè temperato (CR); cuoio (CU); marmo Calacatta Oro (MC); marmo Marquina Nero o Bianco Carrara Gioia (MM).
 E Coffee table cm. 100x100 with painted legs. Available in: smoke tempered glass (CR); saddle leather (CU); Calacatta Oro marble (MC); Black Marquina or White Carrara Gioia marble (MM).
 F Table basse cm. 100x100 avec pied verni. Disponible en: cristal fumé trempé (CR); cuir (CU); marbre Calacatta Oro (MC); marbre noir Marquina ou blanc Carrara Gioia (MM).
 D Tisch cm. 100x100 mit lackiertem Fuss. Lieferbar mit: gehärtetem und rauchgrauerem Glas (CR); Rindleder (CU); Calacatta Oro Marmor (MC); Marmor Marquina schwarz oder weissen Marmor Carrara Gioia (MM).
 S Mesa centro cm. 100x100 con patas pintadas. Disponible en: cristal templado gris (CR); cuero (CU); mármol Calacatta Oro (MC); mármol Marquina negro o bien mármol blanco Carrara Gioia (MM).

cm. 100 x 100 x h 27
 in. 39”% x 39”% x h 10”%

KUBICOTAVQUCR



866,00

KUBICOTAVQUCU



CV 1.270,00
 CF 1.093,00
 CS 870,00

KUBICOTAVQUMC



2.409,00

KUBICOTAVQUMM



1.690,00

I Tavolino cm. 150x70 con piedi verniciati. Disponibile in: cristallo fumè temperato (CR); cuoio (CU); marmo Calacatta Oro (MC); marmo Marquina Nero o Bianco Carrara Gioia (MM).
 E Coffee table cm. 150x70 with painted legs. Available in: smoke tempered glass (CR); saddle leather (CU); Calacatta Oro marble (MC); Black Marquina or White Carrara Gioia marble (MM).
 F Table basse cm. 150x70 avec pied verni. Disponible en: cristal fumé trempé (CR); cuir (CU); marbre Calacatta Oro (MC); marbre noir Marquina ou blanc Carrara Gioia (MM).
 D Tisch cm. 150x70 mit lackiertem Fuss. Lieferbar mit: gehärtetem und rauchgrauerem Glas (CR); Rindleder (CU); Calacatta Oro Marmor (MC); Marmor Marquina schwarz oder weissen Marmor Carrara Gioia (MM).
 S Mesa centro cm. 150x70 con patas pintadas. Disponible en: cristal templado gris (CR); cuero (CU); mármol Calacatta Oro (MC); mármol Marquina negro o bien mármol blanco Carrara Gioia (MM).

cm. 150 x 70 x h 27
 in. 59” x 27”% x h 10”%

KUBICOTAVRECR



953,00

KUBICOTAVRECU



CV 1.396,00
 CF 1.209,00
 CS 975,00

KUBICOTAVREMC



2.554,00

KUBICOTAVREMM



1.807,00

KUBICO - Design Mauro Lipparini

I Tavolino cm. 40x40 con piedi verniciati. Disponibile in: cristallo fumè temperato (CR); cuoio (CU); marmo Calacatta Oro (MC); marmo Marquina Nero o Bianco Carrara Gioia (MM).
 E Coffee table cm. 40x40 with painted legs. Available in: smoke tempered glass (CR); saddle leather (CU); Calacatta Oro marble (MC); Black Marquina or White Carrara Gioia marble (MM).
 F Table basse cm. 40x40 avec pied verni. Disponible en: cristal fumé trempé (CR); cuir (CU); marbre Calacatta Oro (MC); marbre noir Marquina ou blanc Carrara Gioia (MM).
 D Tisch cm. 40x40 mit lackiertem Fuss.Lieferbar mit: gehärtetem und rauchgrauerem Glas (CR); Rindleder (CU); Calacatta Oro Marmor (MC); Marmor Marquina schwarz oder weissen Marmor Carrara Gioia (MM).
 S Mesa centro cm. 40x40 con patas pintadas. Disponible en: cristal templado gris (CR); cuero (CU); mármol Calacatta Oro (MC); mármol Marquina negro o bien mármol blanco Carrara Gioia (MM).

cm. 40 x 40 x h 50
 in. 15³/₄ x 15³/₄ x h 19³/₄

KUBICOTASERCR

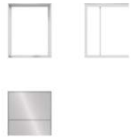

1.031,00

KUBICOTASERCU



CV 893,00
 CF 852,00
 CS 801,00

KUBICOTASERMCMC



1.113,00

KUBICOTASERMMM



997,00

I Tavolino Ø cm. 40 con piedi verniciati. Disponibile in: cristallo fumè temperato (CR); cuoio (CU); marmo Calacatta Oro (MC); marmo Marquina Nero o Bianco Carrara Gioia (MM).
 E Coffee table Ø cm. 40 with painted legs. Available in: smoke tempered glass (CR); saddle leather (CU); Calacatta Oro marble (MC); Black Marquina or White Carrara Gioia marble (MM).
 F Table basse Ø cm. 40 avec pied verni. Disponible en: cristal fumé trempé (CR); cuir (CU); marbre Calacatta Oro (MC); marbre noir Marquina ou blanc Carrara Gioia (MM).
 D Tisch Ø cm. 40 mit lackiertem Fuss.Lieferbar mit: gehärtetem und rauchgrauerem Glas (CR); Rindleder (CU); Calacatta Oro Marmor (MC); Marmor Marquina schwarz oder weissen Marmor Carrara Gioia (MM).
 S Mesa centro Ø cm. 40 con patas pintadas. Disponible en: cristal templado gris (CR); cuero (CU); mármol Calacatta Oro (MC); mármol Marquina negro o bien mármol blanco Carrara Gioia (MM).

cm. 40 x 40 x h 45
 in. 15³/₄ x 15³/₄ x h 17³/₄

KUBICOTAA40CR



706,00

KUBICOTAA40CU



CV 605,00
 CF 561,00
 CS 506,00

KUBICOTAA40MCMC



880,00

KUBICOTAA40MMM



759,00

I Tavolino Ø cm. 40 con piedi verniciati. Disponibile in: cristallo fumè temperato (CR); cuoio (CU); marmo Calacatta Oro (MC); marmo Marquina Nero o Bianco Carrara Gioia (MM).
 E Coffee table Ø cm. 40 with painted legs. Available in: smoke tempered glass (CR); saddle leather (CU); Calacatta Oro marble (MC); Black Marquina or White Carrara Gioia marble (MM).
 F Table basse Ø cm. 40 avec pied verni. Disponible en: cristal fumé trempé (CR); cuir (CU); marbre Calacatta Oro (MC); marbre noir Marquina ou blanc Carrara Gioia (MM).
 D Tisch Ø cm. 40 mit lackiertem Fuss.Lieferbar mit: gehärtetem und rauchgrauerem Glas (CR); Rindleder (CU); Calacatta Oro Marmor (MC); Marmor Marquina schwarz oder weissen Marmor Carrara Gioia (MM).
 S Mesa centro Ø cm. 40 con patas pintadas. Disponible en: cristal templado gris (CR); cuero (CU); mármol Calacatta Oro (MC); mármol Marquina negro o bien mármol blanco Carrara Gioia (MM).

cm. 40 x 40 x h 17
 in. 15³/₄ x 15³/₄ x h 6³/₄

KUBICOTA040CR



678,00

KUBICOTA040CU



CV 556,00
 CF 513,00
 CS 457,00

KUBICOTA040MCMC



852,00

KUBICOTA040MMM



700,00

KUBICO - Design Mauro Lipparini

I Tavolino Ø cm. 60 con piedi verniciati. Disponibile in: cristallo fumè temperato (CR); cuoio (CU); marmo Calacatta Oro (MC); marmo Marquina Nero o Bianco Carrara Gioia (MM).

E Coffee table Ø cm. 60 with painted legs. Available in: smoke tempered glass (CR); saddle leather (CU); Calacatta Oro marble (MC); Black Marquina or White Carrara Gioia marble (MM).

F Table basse Ø cm. 60 avec pied verni. Disponible en: cristal fumé trempé (CR); cuir (CU); marbre Calacatta Oro (MC); marbre noir Marquina ou blanc Carrara Gioia (MM).

D Tisch Ø cm. 60 mit lackiertem Fuss. Lieferbar mit: gehärtetem und rauchgrauerem Glas (CR); Rindleder (CU); Calacatta Oro Marmor (MC); Marmor Marquina schwarz oder weissen Marmor Carrara Gioia (MM).

S Mesa centro Ø cm. 60 con patas pintadas. Disponible en: cristal templado gris (CR); cuero (CU); mármol Calacatta Oro (MC); mármol Marquina negro o bien mármol blanco Carrara Gioia (MM).

cm. 60 x 60 x h 23
in. 23³/₄ x 23³/₄ x h 9¹/₂

KUBICOTA060CR

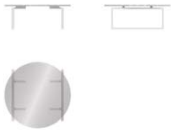

757,00

KUBICOTA060CU

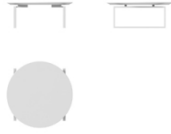

CV 809,00
CF 725,00
CS 619,00

KUBICOTA060MC



1.224,00

KUBICOTA060MM



957,00

I Tavolino Ø cm. 100 con piedi verniciati. Disponibile in: cristallo fumè temperato (CR); cuoio (CU); marmo Calacatta Oro (MC); marmo Marquina Nero o Bianco Carrara Gioia (MM).

E Coffee table Ø cm. 100 with painted legs. Available in: smoke tempered glass (CR); saddle leather (CU); Calacatta Oro marble (MC); Black Marquina or White Carrara Gioia marble (MM).

F Table basse Ø cm. 100 avec pied verni. Disponible en: cristal fumé trempé (CR); cuir (CU); marbre Calacatta Oro (MC); marbre noir Marquina ou blanc Carrara Gioia (MM).

D Tisch Ø cm. 100 mit lackiertem Fuss. Lieferbar mit: gehärtetem und rauchgrauerem Glas (CR); Rindleder (CU); Calacatta Oro Marmor (MC); Marmor Marquina schwarz oder weissen Marmor Carrara Gioia (MM).

S Mesa centro Ø cm. 100 con patas pintadas. Disponible en: cristal templado gris (CR); cuero (CU); mármol Calacatta Oro (MC); mármol Marquina negro o bien mármol blanco Carrara Gioia (MM).

cm. 100 x 100 x h 27
in. 39³/₄ x 39³/₄ x h 10³/₄

KUBICOTA100CR

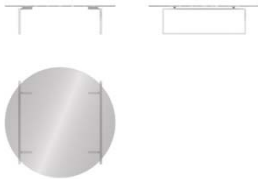

1.033,00

KUBICOTA100CU

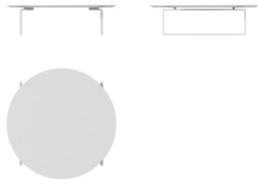

CV 1.283,00
CF 1.106,00
CS 885,00

KUBICOTA100MC



2.410,00

KUBICOTA100MM



1.690,00

I Tavolino Ø cm. 120 con piedi verniciati. Disponibile in: cristallo fumè temperato (CR); cuoio (CU); marmo Calacatta Oro (MC); marmo Marquina Nero o Bianco Carrara Gioia (MM).

E Coffee table Ø cm. 120 with painted legs. Available in: smoke tempered glass (CR); saddle leather (CU); Calacatta Oro marble (MC); Black Marquina or White Carrara Gioia marble (MM).

F Table basse Ø cm. 120 avec pied verni. Disponible en: cristal fumé trempé (CR); cuir (CU); marbre Calacatta Oro (MC); marbre noir Marquina ou blanc Carrara Gioia (MM).

D Tisch Ø cm. 120 mit lackiertem Fuss. Lieferbar mit: gehärtetem und rauchgrauerem Glas (CR); Rindleder (CU); Calacatta Oro Marmor (MC); Marmor Marquina schwarz oder weissen Marmor Carrara Gioia (MM).

S Mesa centro Ø cm. 120 con patas pintadas. Disponible en: cristal templado gris (CR); cuero (CU); mármol Calacatta Oro (MC); mármol Marquina negro o bien mármol blanco Carrara Gioia (MM).

cm. 120 x 120 x h 27
in. 47³/₄ x 47³/₄ x h 10³/₄

KUBICOTA120CR

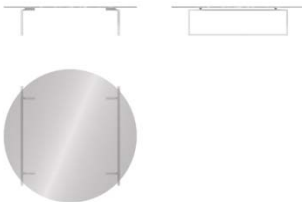

1.177,00

KUBICOTA120CU

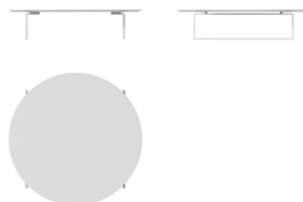

CV 1.444,00
CF 1.239,00
CS 982,00

KUBICOTA120MC



3.233,00

KUBICOTA120MM





2.191,00

KUBICO - Design Mauro Lipparini

I Tavolino Ø cm. 150 con piedi verniciati. Disponibile in: cristallo fumè temperato (CR); cuoio (CU); marmo Calacatta Oro (MC); marmo Marquina Nero o Bianco Carrara Gioia (MM).
 E Coffee table Ø cm. 150 with painted legs. Available in: smoke tempered glass (CR); saddle leather (CU); Calacatta Oro marble (MC); Black Marquina or White Carrara Gioia marble (MM).
 F Table basse Ø cm. 150 avec pied verni. Disponible en: cristal fumé trempé (CR); cuir (CU); marbre Calacatta Oro (MC); marbre noir Marquina ou blanc Carrara Gioia (MM).
 D Tisch Ø cm. 150 mit lackiertem Fuss. Lieferbar mit: gehärtetem und rauchgrauerem Glas (CR); Rindleder (CU); Calacatta Oro Marmor (MC); Marmor Marquina schwarz oder weissen Marmor Carrara Gioia (MM).
 S Mesa centro Ø cm. 150 con patas pintadas. Disponible en: cristal templado gris (CR); cuero (CU); mármol Calacatta Oro (MC); mármol Marquina negro o bien mármol blanco Carrara Gioia (MM).

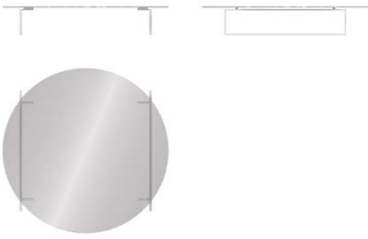
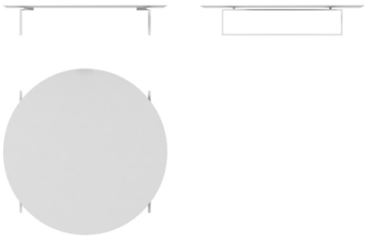
cm. 150 x 150 x h 27
 in. 59" x 59" x h 10 3/4"

KUBICOTA150CR	KUBICOTA150CU	KUBICOTA150MC	KUBICOTA150MM
			
1.593,00	CV 1.984,00 CF 1.666,00 CS 1.105,00	4.792,00	3.161,00

KUBICOSUPPTAVCR

I Supplemento per basamento cromato per ogni singolo tavolino o panca. 141,00
 E Extra charge for chromed base for every single coffee table or bench.
 F Supplément pour piétement chromé pour chaque single table basse ou banc.
 D Mehrpreis fuer verchromtem Gestell fuer jede Tisch oder Bank.
 S Suplemento para la base cromada de cada mesa centro o bancada.

KUBICOSUPPTAVBR

I Supplemento per basamento bronzato per ogni singolo tavolino o panca. 160,00
 E Extra charge for bronze base for every single coffee table or bench.
 F Supplément pour piétement bronzé pour chaque single table basse ou banc.
 D Mehrpreis fuer bronzefarben Gestell fuer jede Tisch oder Bank.
 S Suplemento para la base bronceada de cada mesa centro o bancada.

MANTA - Design Matteo Nunziati



Struttura. Schienale e sedile in tubolare d'acciaio; il molleggio è garantito da cinghie elastiche in polipropilene e lattice naturale fissate alla struttura in acciaio. Le due strutture separate di schienale e sedile sono annegate in poliuretano espanso con densità di 45 kg/m³, schiumato a freddo in due opportuni stampi e rivestite con fibre di poliestere. La schiuma poliuretanicca soddisfa la classe 1 IM di resistenza al fuoco secondo la legge italiana ed è disponibile anche secondo altri standard internazionali.

Base. Quattro piedini in PVC nero.

Rivestimento. Disponibile in tessuto e pelle; non sfoderabile.

Frame. The frame of the backrest and of the seat is in tubular steel; the webbing is secured by elastic polypropylene and natural latex belts fixed to the metal frame. The two frames are embedded in cold formed polyurethane foam with density of 45 kg/m³, made in two different moulds and covered by polyester wadding. The foam comply to the Italian Classe 1IM fire resistant law and is available on request for other international standards.

Base. Four feet in black PVC.

Covers. Available in fabric or leather; non removable covers.

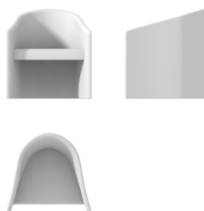

MANTAOPOLTRON

I Poltrona.
E Armchair.
F Fauteuil.
D Sessel.
S Butaca.

cm. 78 x 70 x h 81 – hs 48 • mt. 3.40
in. 30³/₄ x 27¹/₂ x h 31⁷/₈ – hs 18⁷/₈ • yd. 3.70

COM	1.154,00
L	1.224,00
T	1.308,00
S	1.378,00
Z	1.463,00
K	1.534,00
PS	1.895,00
PF	2.168,00
PX	2.604,00
PA	3.013,00

MARNIE - Design Adam Tihany



Struttura. Lo schienale è in multistrato di faggio curvato in stampo. Il sedile è in legno massello di pioppo (stagionato "naturalmente" per almeno 3 anni); giunzioni a incastro con spine cilindriche. Il molleggio è garantito da cinghie elastiche in polipropilene e lattice naturale. L'imbottitura della struttura è ottenuta con lastre di poliuretano espanso indeformabile a densità differenziate (30÷35 kg/m³) esente da CFC ricoperto da ovatta poliestere e vellutino accoppiato. L'imbottitura dello schienale della sola poltrona è realizzata con poliuretano espanso, schiumato a freddo in stampo. La schiuma poliuretanicca soddisfa la classe 1 IM di resistenza al fuoco secondo la legge italiana ed è disponibile anche secondo altri standard internazionali.

Cuscini. Cuscini di seduta poliuretano espanso, schiumato a freddo in stampo e ricoperti con ovatta poliestere. La schiuma poliuretanicca soddisfa la classe 1 IM di resistenza al fuoco secondo la legge italiana ed è disponibile anche secondo altri standard internazionali. I cuscini di seduta sono dotati di bordo a palloncino.

Base. Supporti in legno massello di pioppo (stagionato "naturalmente" per almeno 3 anni) rivestiti in cuoio. Su richiesta è disponibile un basamento d'acciaio girevole.

Rivestimento. Disponibile in tessuto e pelle; non sfoderabile.

Frame. The backrest is in beech plywood curved into a mould. The seat is in solid poplar heartwood ("naturally" seasoned for at least 3 years); dap joints with cylindrical dowels. The webbing is secured by elastic polypropylene and natural latex belts. The framework is upholstered with contoured sheets of resilient, CFC-free polyurethane foam (with density of 30÷35 kg/m³) covered by polyester wadding and bonded plush. The backrest of the armchair only is made with cold formed polyurethane foam made in mould. The foam complies with the Italian Classe 1IM fire resistant law and is available on request for other international standards.

Cushions. The seat cushions are made in cold formed polyurethane foam, made in mould and covered by polyester wadding. The foam complies with the Italian Classe 1IM fire resistant law and is available on request for other international standards. The seat cushions are equipped with piping.

Base. Supports solid poplar heartwood ("naturally" seasoned for at least 3 years) and covered in saddle leather. Available on request also a metal swivel base.

Covers. Available in fabric or leather; non removable covers.

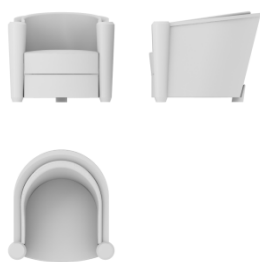

MARNIEPOLTRON

- I Poltrona.
- E Armchair.
- F Fauteuil.
- D Sessel.
- S Butaca.

cm. 93 x 95 x h 76 – hs 45 • mt. 4.40
in. 36³/₈ x 37³/₈ x h 29³/₈ – hs 17³/₈ • yd. 4.80

COM	3.598,00
L	3.702,00
T	3.827,00
S	3.932,00
Z	4.057,00
K	4.162,00
PS	4.361,00
PF	4.684,00
PX	5.389,00
PA	5.923,00

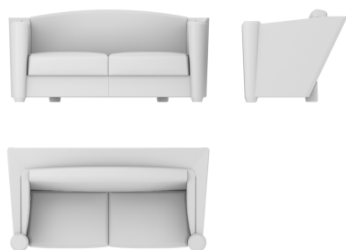

MARNIEDIVA2PO

- I Divano 2 posti.
- E 2 seater sofa.
- F Canapé 2 places.
- D Sofa 2-sitzig.
- S Sofá de 2 plazas.

cm. 184 x 95 x h 76 – hs 45 • mt. 7.70
in. 72¹/₂ x 37³/₈ x h 29³/₈ – hs 17³/₈ • yd. 8.40

COM	4.521,00
L	4.702,00
T	4.920,00
S	5.103,00
Z	5.320,00
K	5.502,00
PS	5.978,00
PF	6.582,00
PX	7.902,00
PA	8.899,00

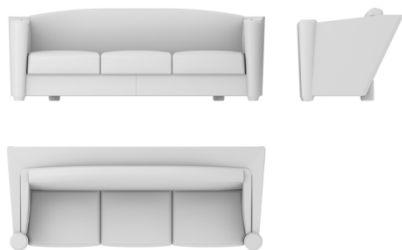

MARNIEDIVA3PO

- I Divano 3 posti.
- E 3 seater sofa.
- F Canapé 3 places.
- D Sofa 3-sitzig.
- S Sofá de 3 plazas.

cm. 236 x 95 x h 76 – hs 45 • mt. 11.00
in. 92¹/₂ x 37³/₈ x h 29³/₈ – hs 17³/₈ • yd. 12.00

COM	6.142,00
L	6.390,00
T	6.688,00
S	6.936,00
Z	7.234,00
K	7.482,00
PS	7.926,00
PF	8.685,00
PX	10.340,00
PA	11.593,00

MARNIE - Design Adam Tihany



MARNIEPOUF000

- I Pouf.
- E Ottoman.
- F Pouf.
- D Hocker.
- S Pouf.

cm. 65 x 53 x h 42 – hs 42 • mt. 2.00
 in. 25³/₈ x 20³/₈ x h 16¹/₂ – hs 16¹/₂ • yd. 2.20

COM	1.374,00
L	1.434,00
T	1.507,00
S	1.567,00
Z	1.639,00
K	1.700,00
PS	1.796,00
PF	1.978,00
PX	2.383,00
PA	2.685,00

MARNIESUPGIRE

- I Supplemento per poltrona girevole.
- E Extra charge for swivel base on armchair.
- F Supplément pour pied tournant de fauteuil.
- D Mehrpreis fuer Drehbasis auf Sessel.
- S Suplemento para sillón giratorio.

491,00

MOORE RELAX - Design Umberto Asnago



Struttura. Schienale in multistrato di pioppo curvato in stampo; sedile in legno massello di pioppo (stagionato "naturalmente" per almeno 3 anni); giunzioni a incastro con spine cilindriche. Il molleggio è garantito da cinghie elastiche in polipropilene e lattice naturale. L'imbottitura della struttura è ottenuta con lastre di poliuretano espanso indeformabile a densità differenziate (30÷35 kg/m³) esente da CFC ricoperto da ovatta poliestere.

Base. In alluminio verniciato a polveri epossidiche in colore titanio.

Rivestimento. Disponibile in tessuto e pelle; è caratterizzato da una trapuntatura a forma esagonale. Non sfoderabile.

Frame. Back in poplar plywood panels curved in mould; seat in solid poplar heartwood ("naturally" seasoned for at least 3 years); dap joints with cylindrical dowels. The webbing is secured by elastic polypropylene and natural latex belts. The framework is upholstered with contoured sheets of resilient, CFC-free polyurethane foam (with density of 30÷35 kg/m³) covered by polyester wadding.

Base. In aluminum epoxy powder painted in titanium color.

Covers. Available in fabric or leather; is characterized by hexagonal quilting. Non removable covers.



MOOREPOLTGIR

I Poltrona relax girevole con base verniciata colore titanio.

E Relax armchair with swivel base varnished in titanium colour.

F Fauteuil relax tournant avec pietément verni en couleur titane.

D Drehsessel relax mit Fuss lackiertem titanium Farbe.

S Sillón relax giratorio con base pintada en color de titanio.

cm. 72 x 92 x h 94 – hs 42 • mt. 3.90

in. 28³/₄ x 36³/₄ x h 37" – hs 16³/₄ • yd. 4.25

COM	2.139,00
L	2.216,00
T	2.306,00
S	2.381,00
Z	2.472,00
K	2.548,00
PS	2.763,00
PF	3.023,00
PX	3.439,00
PA	3.829,00

NIKY - Design Daniele Lo Scalzo Moscheri



Struttura. In legno massello di pioppo (stagionato "naturalmente" per almeno 3 anni) con elementi in pannello nobilitato; giunzioni a incastro con spine cilindriche. Il molleggio è garantito da cinghie elastiche in polipropilene e lattice naturale. L'imbottitura della struttura è ottenuta con lastre di poliuretano espanso indeformabile a densità differenziate (30÷35 kg/m³) esente da CFC ricoperto da ovatta poliestere e vellutino accoppiato. La base della struttura può essere imbottita e rivestita in pelle o tessuto oppure in legno massello di noce canaletto.

Cuscini. I cuscini di seduta sono in poliuretano espanso con densità di 40 kg/m³ con parte frontale e superiore del cuscino in Rollofill®.

Base. Piedini in tubolare d'acciaio verniciato a polveri epossidiche in colore nero. Le estremità sono in acciaio con finitura galvanica dorata.

Rivestimento. Disponibile in tessuto e pelle; sfoderabile solo nella per i cuscini di seduta.

Frame. In solid poplar heartwood ("naturally" seasoned for at least 3 years) with connecting elements in melamine coated panels; dap joints with cylindrical dowels. The webbing is secured by elastic polypropylene and natural latex belts. The framework is upholstered with contoured sheets of resilient, CFC-free polyurethane foam (with density of 30÷35 kg/m³) covered by polyester wadding and bonded plush. The base of the frame can be upholstered and covered in leather or fabric or also in solid black walnut heartwood.

Cushions. The seat cushions are in polyurethane foam with density of 40 kg/m³ with front and upper part in Rollofill®.

Base. Supports in tubular steel epoxy powder black painted with terminal support in steel with golden galvanic finishing.

Covers. Available in fabric or leather; removable covers only for seat cushions.



NIKY00DIVA180

- I Divano 2 posti cm. 180.
- E 2 seater sofa cm. 180.
- F Canapé 2 places cm. 180.
- D Sofa 2-sitzig cm. 180.
- S Sofá de 2 plazas 180.

cm. 180 x 100 x h 83 – hs 43.5 • mt. 9.60
in. 70" x 39" x h 32" – hs 17" • yd. 10.50

COM	3.571,00
L	3.769,00
T	4.006,00
S	4.203,00
Z	4.440,00
K	4.638,00
PS	5.368,00
PF	6.096,00
PX	7.258,00
PA	8.348,00



NIKY00CENT140

- I Divano senza braccioli cm. 140.
- E Sofa without arms cm. 140.
- F Canapé sans accoudoirs cm. 140.
- D Sofa ohne Armlehnen cm. 140.
- S Sofá sin brazos cm. 140.

cm. 140 x 100 x h 83 – hs 43.5 • mt. 6.50
in. 55" x 39" x h 32" – hs 17" • yd. 7.10

COM	2.963,00
L	3.097,00
T	3.258,00
S	3.392,00
Z	3.552,00
K	3.686,00
PS	4.158,00
PF	4.643,00
PX	5.421,00
PA	6.150,00









NIKY00D160BDX

- I Divano 2 posti cm. 160, con bracciolo destro.
- E 2 seater sofa cm. 160, with right arm.
- F Canapé 2 places cm. 160, avec accoudoir droit.
- D Sofa 2-sitzig cm. 160, mit rechter Armlehne.
- S Sofá de 2 plazas 160, con brazo derecho.

cm. 160 x 100 x h 83 – hs 43.5 • mt. 8.00
in. 63" x 39" x h 32" – hs 17" • yd. 8.75

COM	3.266,00
L	3.432,00
T	3.631,00
S	3.797,00
Z	3.995,00
K	4.161,00
PS	4.740,00
PF	5.340,00
PX	6.299,00
PA	7.199,00







NIKY - Design Daniele Lo Scalzo Moscheri

	<p>NIKY00D160BSX</p> <p>I Divano 2 posti cm. 160, con bracciolo sinistro. E 2 seater sofa cm. 160, with left arm. F Canapé 2 places cm. 160, avec accoudoir gauche. D Sofa 2-sitzig cm. 160, mit linker Armlehne. S Sofá de 2 plazas 160, con brazo izquierdo.</p>	<p>COM 3.266,00 L 3.432,00 T 3.631,00 S 3.797,00 Z 3.995,00 K 4.161,00 PS 4.740,00 PF 5.340,00 PX 6.299,00 PA 7.199,00</p>
<p>cm. 160 x 100 x h 83 – hs 43.5 • mt. 8.00 in. 63" x 39" x h 32" – hs 17" • yd. 8.75</p>		
	<p>NIKY00D175ADX</p> <p>I Divano 2 posti cm. 175, con angolo destro. E 2 seater sofa cm. 175, with right angle. F Canapé 2 places cm. 175, avec angle droit. D Sofa 2-sitzig cm. 175, mit Winkel rechts. S Sofá de 2 plazas 175, con rincón derecho.</p>	<p>COM 3.388,00 L 3.569,00 T 3.787,00 S 3.969,00 Z 4.187,00 K 4.368,00 PS 4.980,00 PF 5.630,00 PX 6.669,00 PA 7.644,00</p>
<p>cm. 175 x 100 x h 83 – hs 43.5 • mt. 8.80 in. 68" x 39" x h 32" – hs 17" • yd. 9.65</p>		
	<p>NIKY00D175ASX</p> <p>I Divano 2 posti cm. 175, con angolo sinistro. E 2 seater sofa cm. 175, with left angle. F Canapé 2 places cm. 175, avec angle gauche. D Sofa 2-sitzig cm. 175, mit Winkel links. S Sofá de 2 plazas 175, con rincón izquierdo.</p>	<p>COM 3.388,00 L 3.569,00 T 3.787,00 S 3.969,00 Z 4.187,00 K 4.368,00 PS 4.980,00 PF 5.630,00 PX 6.669,00 PA 7.644,00</p>
<p>cm. 175 x 100 x h 83 – hs 43.5 • mt. 8.80 in. 68" x 39" x h 32" – hs 17" • yd. 9.65</p>		
	<p>NIKY00B195ADX</p> <p>I Divano 2 posti cm. 195, con bracciolo sinistro ed angolo destro. E 2 seater sofa cm. 195, with left arm and right angle. F Canapé 2 places cm. 195, avec accoudoir gauche et angle droit. D Sofa 2-sitzig cm. 195, mit linker Armlehne und Winkel rechts. S Sofá de 2 plazas 195, con brazo izquierdo y rincón derecho.</p>	<p>COM 3.700,00 L 3.913,00 T 4.169,00 S 4.383,00 Z 4.639,00 K 4.852,00 PS 5.644,00 PF 6.430,00 PX 7.688,00 PA 8.866,00</p>
<p>cm. 195 x 100 x h 83 – hs 43.5 • mt. 10.35 in. 76" x 39" x h 32" – hs 17" • yd. 11.30</p>		
	<p>NIKY00B195ASX</p> <p>I Divano 2 posti cm. 195, con bracciolo destro ed angolo sinistro. E 2 seater sofa cm. 195, with right arm and left angle. F Canapé 2 places cm. 195, avec accoudoir droit et angle gauche. D Sofa 2-sitzig cm. 195, mit rechter Armlehne und Winkel links. S Sofá de 2 plazas 195 con brazo derecho y rincón izquierdo.</p>	<p>COM 3.700,00 L 3.913,00 T 4.169,00 S 4.383,00 Z 4.639,00 K 4.852,00 PS 5.644,00 PF 6.430,00 PX 7.688,00 PA 8.866,00</p>
<p>cm. 195 x 100 x h 83 – hs 43.5 • mt. 10.35 in. 76" x 39" x h 32" – hs 17" • yd. 11.30</p>		
	<p>NIKY00CH145DX</p> <p>I Chaiselongue destra cm. 145. E Right chaiselongue cm. 145. F Dormeuse droite cm. 145. D Rechte Dormeuse cm. 145. S Chaise longue derecha cm. 145.</p>	<p>COM 2.939,00 L 3.070,00 T 3.228,00 S 3.360,00 Z 3.517,00 K 3.649,00 PS 4.128,00 PF 4.609,00 PX 5.380,00 PA 6.102,00</p>
<p>cm. 145 x 100 x h 83 – hs 43.5 • mt. 6.40 in. 57" x 39" x h 32" – hs 17" • yd. 7.00</p>		

NIKY - Design Daniele Lo Scalzo Moscheri

	<p>NIKY00CH145SX</p> <p>I Chaiselongue sinistral cm. 145. E Left chaiselongue cm. 145. F Dormeuse gauche cm. 145. D Linke Dormeuse cm. 145. S Chaise longue izquierda cm. 145.</p>	<p>COM 2.939,00 L 3.070,00 T 3.228,00 S 3.360,00 Z 3.517,00 K 3.649,00 PS 4.128,00 PF 4.609,00 PX 5.380,00 PA 6.102,00</p>
	<p>NIKY00PE140DX</p> <p>I Penisola lineare destra cm. 140. E Right linear chaiselongue cm. 140. F Dormeuse linéaire droite cm. 140. D Rechte lineare Dormeuse cm. 140. S Chaise longue lineal derecha cm. 140.</p>	<p>COM 2.720,00 L 2.820,00 T 2.940,00 S 3.040,00 Z 3.159,00 K 3.259,00 PS 3.615,00 PF 3.979,00 PX 4.560,00 PA 5.106,00</p>
	<p>NIKY00PE140SX</p> <p>I Penisola lineare sinistral cm. 140. E Left linear chaiselongue cm. 140. F Dormeuse linéaire gauche cm. 140. D Linke lineare Dormeuse cm. 140. S Chaise longue lineal izquierda cm. 140.</p>	<p>COM 2.720,00 L 2.820,00 T 2.940,00 S 3.040,00 Z 3.159,00 K 3.259,00 PS 3.615,00 PF 3.979,00 PX 4.560,00 PA 5.106,00</p>
	<p>NIKY00DIVA210</p> <p>I Divano 2 posti cm. 210. E 2 seater sofa cm. 210. F Canapé 2 places cm. 210. D Sofa 2-sitzig cm. 210. S Sofá de 2 plazas 210.</p>	<p>COM 3.847,00 L 4.063,00 T 4.322,00 S 4.538,00 Z 4.797,00 K 5.013,00 PS 5.787,00 PF 6.572,00 PX 7.830,00 PA 9.008,00</p>
	<p>NIKY00CENT170</p> <p>I Divano senza braccioli cm. 170. E Sofa without arms cm. 170. F Canapé sans accoudoirs cm. 170. D Sofa ohne Armlehnen cm. 170. S Sofá sin brazos cm. 170.</p>	<p>COM 3.241,00 L 3.394,00 T 3.576,00 S 3.729,00 Z 3.911,00 K 4.063,00 PS 4.593,00 PF 5.142,00 PX 6.021,00 PA 6.846,00</p>
	<p>NIKY00D190BDX</p> <p>I Divano 2 posti cm. 190, con bracciolo destro. E 2 seater sofa cm. 190, with right arm. F Canapé 2 places cm. 190, avec accoudoir droit. D Sofa 2-sitzig cm. 190, mit rechter Armlehne. S Sofá de 2 plazas 190, con brazo derecho.</p>	<p>COM 3.544,00 L 3.729,00 T 3.949,00 S 4.133,00 Z 4.354,00 K 4.538,00 PS 5.175,00 PF 5.838,00 PX 6.899,00 PA 7.894,00</p>







NIKY - Design Daniele Lo Scalzo Moscheri

	<p>NIKY00D190BSX</p> <p>I Divano 2 posti cm. 190, con bracciolo sinistro. E 2 seater sofa cm. 190, with left arm. F Canapé 2 places cm. 190, avec accoudoir gauche. D Sofa 2-sitzig cm. 190, mit linker Armlehne. S Sofá de 2 plazas 190, con brazo izquierdo.</p>	<p>COM 3.544,00 L 3.729,00 T 3.949,00 S 4.133,00 Z 4.354,00 K 4.538,00 PS 5.175,00 PF 5.838,00 PX 6.899,00 PA 7.894,00</p>
<p>cm. 190 x 100 x h 83 – hs 43.5 • mt. 8.90 in. 74”$\frac{3}{4}$ x 39”$\frac{3}{4}$ x h 32”$\frac{3}{4}$ – hs 17”$\frac{3}{4}$ • yd. 9.75</p>		
	<p>NIKY00D205ADX</p> <p>I Divano 2 posti cm. 205, con angolo destro. E 2 seater sofa cm. 205, with right angle. F Canapé 2 places cm. 205, avec angle droit. D Sofa 2-sitzig cm. 205, mit Winkel rechts. S Sofá de 2 plazas 205, con rincón derecho.</p>	<p>COM 3.664,00 L 3.864,00 T 4.104,00 S 4.303,00 Z 4.543,00 K 4.743,00 PS 5.441,00 PF 6.165,00 PX 7.320,00 PA 8.403,00</p>
<p>cm. 205 x 100 x h 83 – hs 43.5 • mt. 9.70 in. 80”$\frac{3}{4}$ x 39”$\frac{3}{4}$ x h 32”$\frac{3}{4}$ – hs 17”$\frac{3}{4}$ • yd. 10.60</p>		
	<p>NIKY00D205ASX</p> <p>I Divano 2 posti cm. 205, con angolo sinistro. E 2 seater sofa cm. 205, with left angle. F Canapé 2 places cm. 205, avec angle gauche. D Sofa 2-sitzig cm. 205, mit Winkel links. S Sofá de 2 plazas 205, con rincón izquierdo.</p>	<p>COM 3.664,00 L 3.864,00 T 4.104,00 S 4.303,00 Z 4.543,00 K 4.743,00 PS 5.441,00 PF 6.165,00 PX 7.320,00 PA 8.403,00</p>
<p>cm. 205 x 100 x h 83 – hs 43.5 • mt. 9.70 in. 80”$\frac{3}{4}$ x 39”$\frac{3}{4}$ x h 32”$\frac{3}{4}$ – hs 17”$\frac{3}{4}$ • yd. 10.60</p>		
	<p>NIKY00B225ADX</p> <p>I Divano 2 posti cm. 225, con bracciolo sinistro ed angolo destro. E 2 seater sofa cm. 225, with left arm and right angle. F Canapé 2 places cm. 225, avec accoudoir gauche et angle droit. D Sofa 2-sitzig cm. 225, mit linker Armlehne und Winkel rechts. S Sofá de 2 plazas 225, con brazo izquierdo y rincón derecho.</p>	<p>COM 3.964,00 L 4.196,00 T 4.474,00 S 4.706,00 Z 4.984,00 K 5.216,00 PS 6.051,00 PF 6.897,00 PX 8.248,00 PA 9.516,00</p>
<p>cm. 225 x 100 x h 83 – hs 43.5 • mt. 11.20 in. 88”$\frac{1}{2}$ x 39”$\frac{3}{4}$ x h 32”$\frac{3}{4}$ – hs 17”$\frac{3}{4}$ • yd. 12.25</p>		
	<p>NIKY00B225ASX</p> <p>I Divano 2 posti cm. 225, con bracciolo destro ed angolo sinistro. E 2 seater sofa cm. 225, with right arm and left angle. F Canapé 2 places cm. 225, avec accoudoir droit et angle gauche. D Sofa 2-sitzig cm. 225, mit rechter Armlehne und Winkel links. S Sofá de 2 plazas 225, con brazo derecho y rincón izquierdo.</p>	<p>COM 3.964,00 L 4.196,00 T 4.474,00 S 4.706,00 Z 4.984,00 K 5.216,00 PS 6.051,00 PF 6.897,00 PX 8.248,00 PA 9.516,00</p>
<p>cm. 225 x 100 x h 83 – hs 43.5 • mt. 11.20 in. 88”$\frac{1}{2}$ x 39”$\frac{3}{4}$ x h 32”$\frac{3}{4}$ – hs 17”$\frac{3}{4}$ • yd. 12.25</p>		
	<p>NIKY00CH175DX</p> <p>I Chaiselongue destra cm. 175. E Right chaiselongue cm. 175. F Dormeuse droite cm. 175. D Rechte Dormeuse cm. 175. S Chaise longue derecha cm. 175.</p>	<p>COM 3.211,00 L 3.365,00 T 3.550,00 S 3.705,00 Z 3.890,00 K 4.045,00 PS 4.545,00 PF 5.090,00 PX 5.963,00 PA 6.779,00</p>
<p>cm. 175 x 100 x h 83 – hs 43.5 • mt. 7.50 in. 68”$\frac{3}{4}$ x 39”$\frac{3}{4}$ x h 32”$\frac{3}{4}$ – hs 17”$\frac{3}{4}$ • yd. 8.20</p>		

NIKY - Design Daniele Lo Scalzo Moscheri

	<p>NIKY00CH175SX</p> <p>I Chaiselongue sinistral cm. 175. E Left chaiselongue cm. 175. F Dormeuse gauche cm. 175. D Linke Dormeuse cm. 175. S Chaise longue izquierda cm. 175.</p>	<p>COM 3.211,00 L 3.365,00 T 3.550,00 S 3.705,00 Z 3.890,00 K 4.045,00 PS 4.545,00 PF 5.090,00 PX 5.963,00 PA 6.779,00</p>
<p>cm. 175 x 100 x h 83 – hs 43.5 • mt. 7.50 in. 68”% x 39”% x h 32”% – hs 17”% • yd. 8.20</p>		
	<p>NIKY00PE170DX</p> <p>I Penisola lineare destra cm. 170. E Right linear chaiselongue cm. 170. F Dormeuse lineaire droite cm. 170. D Rechte lineare Dormeuse cm. 170. S Chaise longue lineal derecha cm. 170.</p>	<p>COM 2.975,00 L 3.093,00 T 3.234,00 S 3.353,00 Z 3.495,00 K 3.612,00 PS 4.026,00 PF 4.454,00 PX 5.137,00 PA 5.777,00</p>
<p>cm. 170 x 100 x h 83 – hs 43.5 • mt. 5.70 in. 66”% x 39”% x h 32”% – hs 17”% • yd. 6.25</p>		
	<p>NIKY00PE170SX</p> <p>I Penisola lineare sinistral cm. 170. E Left linear chaiselongue cm. 170. F Dormeuse lineaire gauche cm. 170. D Linke lineare Dormeuse cm. 170. S Chaise longue lineal izquierda cm. 170.</p>	<p>COM 2.975,00 L 3.093,00 T 3.234,00 S 3.353,00 Z 3.495,00 K 3.612,00 PS 4.026,00 PF 4.454,00 PX 5.137,00 PA 5.777,00</p>
<p>cm. 170 x 100 x h 83 – hs 43.5 • mt. 5.70 in. 66”% x 39”% x h 32”% – hs 17”% • yd. 6.25</p>		
	<p>NIKY00DIVA230</p> <p>I Divano 2 posti cm. 230. E 2 seater sofa cm. 230. F Canapé 2 places cm. 230. D Sofa 2-sitzig cm. 230. S Sofá de 2 plazas 230.</p>	<p>COM 4.114,00 L 4.348,00 T 4.629,00 S 4.863,00 Z 5.143,00 K 5.378,00 PS 6.253,00 PF 7.116,00 PX 8.498,00 PA 9.791,00</p>
<p>cm. 230 x 100 x h 83 – hs 43.5 • mt. 11.35 in. 90”% x 39”% x h 32”% – hs 17”% • yd. 12.40</p>		
	<p>NIKY00CENT190</p> <p>I Divano senza braccioli cm. 190. E Sofa without arms cm. 190. F Canapé sans accoudoirs cm. 190. D Sofa ohne Armlehnen cm. 190. S Sofá sin brazos cm. 190.</p>	<p>COM 3.494,00 L 3.664,00 T 3.869,00 S 4.039,00 Z 4.243,00 K 4.414,00 PS 5.073,00 PF 5.709,00 PX 6.727,00 PA 7.681,00</p>
<p>cm. 190 x 100 x h 83 – hs 43.5 • mt. 8.25 in. 74”% x 39”% x h 32”% – hs 17”% • yd. 9.05</p>		
	<p>NIKY00D210BDX</p> <p>I Divano 2 posti cm. 210, con bracciolo destro. E 2 seater sofa cm. 210, with right arm. F Canapé 2 places cm. 210, avec accoudoir droit. D Sofa 2-sitzig cm. 210, mit rechter Armlehne. S Sofá de 2 plazas 210, con brazo derecho.</p>	<p>COM 3.806,00 L 4.009,00 T 4.251,00 S 4.453,00 Z 4.696,00 K 4.898,00 PS 5.666,00 PF 6.416,00 PX 7.615,00 PA 8.739,00</p>
<p>cm. 210 x 100 x h 83 – hs 43.5 • mt. 9.80 in. 82”% x 39”% x h 32”% – hs 17”% • yd. 10.70</p>		

NIKY - Design Daniele Lo Scalzo Moscheri

	<p>NIKY00D210BSX</p> <p>I Divano 2 posti cm. 210, con bracciolo sinistro. E 2 seater sofa cm. 210, with left arm. F Canapé 2 places cm. 210, avec accoudoir gauche. D Sofa 2-sitzig cm. 210, mit linker Armlehne. S Sofá de 2 plazas 210, con brazo izquierdo.</p>	<p>COM 3.806,00 L 4.009,00 T 4.251,00 S 4.453,00 Z 4.696,00 K 4.898,00 PS 5.666,00 PF 6.416,00 PX 7.615,00 PA 8.739,00</p>
<p>cm. 210 x 100 x h 83 – hs 43.5 • mt. 9.80 in. 82”½ x 39”¾ x h 32”¾ – hs 17”¾ • yd. 10.70</p>		
	<p>NIKY00D225ADX</p> <p>I Divano 2 posti cm. 225, con angolo destro. E 2 seater sofa cm. 225, with right angle. F Canapé 2 places cm. 225, avec angle droit. D Sofa 2-sitzig cm. 225, mit Winkel rechts. S Sofá de 2 plazas 225, con rincón derecho.</p>	<p>COM 3.914,00 L 4.132,00 T 4.394,00 S 4.611,00 Z 4.873,00 K 5.091,00 PS 5.921,00 PF 6.730,00 PX 8.024,00 PA 9.236,00</p>
<p>cm. 225 x 100 x h 83 – hs 43.5 • mt. 10.55 in. 88”½ x 39”¾ x h 32”¾ – hs 17”¾ • yd. 11.55</p>		
	<p>NIKY00D225ASX</p> <p>I Divano 2 posti cm. 225, con angolo sinistro. E 2 seater sofa cm. 225, with left angle. F Canapé 2 places cm. 225, avec angle gauche. D Sofa 2-sitzig cm. 225, mit Winkel links. S Sofá de 2 plazas 225, con rincón izquierdo.</p>	<p>COM 3.914,00 L 4.132,00 T 4.394,00 S 4.611,00 Z 4.873,00 K 5.091,00 PS 5.921,00 PF 6.730,00 PX 8.024,00 PA 9.236,00</p>
<p>cm. 225 x 100 x h 83 – hs 43.5 • mt. 10.55 in. 88”½ x 39”¾ x h 32”¾ – hs 17”¾ • yd. 11.55</p>		
	<p>NIKY00B245ADX</p> <p>I Divano 2 posti cm. 245, con bracciolo sinistro ed angolo destro. E 2 seater sofa cm. 245, with left arm and right angle. F Canapé 2 places cm. 245, avec accoudoir gauche et angle droit. D Sofa 2-sitzig cm. 245, mit linker Armlehne und Winkel rechts. S Sofá de 2 plazas 245, con brazo izquierdo y rincón derecho.</p>	<p>COM 4.232,00 L 4.482,00 T 4.781,00 S 5.032,00 Z 5.331,00 K 5.581,00 PS 6.519,00 PF 7.441,00 PX 8.916,00 PA 10.299,00</p>
<p>cm. 245 x 100 x h 83 – hs 43.5 • mt. 12.10 in. 96”½ x 39”¾ x h 32”¾ – hs 17”¾ • yd. 13.25</p>		
	<p>NIKY00B245ASX</p> <p>I Divano 2 posti cm. 245, con bracciolo destro ed angolo sinistro. E 2 seater sofa cm. 245, with right arm and left angle. F Canapé 2 places cm. 245, avec accoudoir droit et angle gauche. D Sofa 2-sitzig cm. 245, mit rechter Armlehne und Winkel links. S Sofá de 2 plazas 245, con brazo derecho y rincón izquierdo.</p>	<p>COM 4.232,00 L 4.482,00 T 4.781,00 S 5.032,00 Z 5.331,00 K 5.581,00 PS 6.519,00 PF 7.441,00 PX 8.916,00 PA 10.299,00</p>
<p>cm. 245 x 100 x h 83 – hs 43.5 • mt. 12.10 in. 96”½ x 39”¾ x h 32”¾ – hs 17”¾ • yd. 13.25</p>		
	<p>NIKY00CH195DX</p> <p>I Chaiselongue destra cm. 195. E Right chaiselongue cm. 195. F Dormeuse droite cm. 195. D Rechte Dormeuse cm. 195. S Chaise longue derecha cm. 195.</p>	<p>COM 3.474,00 L 3.643,00 T 3.844,00 S 4.013,00 Z 4.214,00 K 4.383,00 PS 5.035,00 PF 5.662,00 PX 6.665,00 PA 7.606,00</p>
<p>cm. 195 x 100 x h 83 – hs 43.5 • mt. 8.15 in. 76”¾ x 39”¾ x h 32”¾ – hs 17”¾ • yd. 8.90</p>		

NIKY - Design Daniele Lo Scalzo Moscheri



NIKY00CH195SX
 I Chaiselongue sinistra cm. 195.
 E Left chaiselongue cm. 195.
 F Dormeuse gauche cm. 195.
 D Linke Dormeuse cm. 195.
 S Chaise longue izquierda cm. 195.

cm. 195 x 100 x h 83 – hs 43.5 • mt. 8.15
 in. 76” $\frac{3}{4}$ x 39” $\frac{3}{4}$ x h 32” $\frac{3}{4}$ – hs 17” $\frac{3}{4}$ • yd. 8.90

COM	3.474,00
L	3.643,00
T	3.844,00
S	4.013,00
Z	4.214,00
K	4.383,00
PS	5.035,00
PF	5.662,00
PX	6.665,00
PA	7.606,00



NIKY00PE190DX
 I Penisola lineare destra cm. 190.
 E Right linear chaiselongue cm. 190.
 F Dormeuse linéaire droite cm. 190.
 D Rechte lineare Dormeuse cm. 190.
 S Chaise longue lineal derecha cm. 190.

cm. 190 x 100 x h 83 – hs 43.5 • mt. 6.60
 in. 74” $\frac{3}{4}$ x 39” $\frac{3}{4}$ x h 32” $\frac{3}{4}$ – hs 17” $\frac{3}{4}$ • yd. 7.20

COM	3.261,00
L	3.397,00
T	3.561,00
S	3.697,00
Z	3.860,00
K	3.996,00
PS	4.541,00
PF	5.055,00
PX	5.876,00
PA	6.646,00



NIKY00PE190SX
 I Penisola lineare sinistra cm. 190.
 E Left linear chaiselongue cm. 190.
 F Dormeuse linéaire gauche cm. 190.
 D Linke lineare Dormeuse cm. 190.
 S Chaise longue lineal izquierda cm. 190

cm. 190 x 100 x h 83 – hs 43.5 • mt. 6.60
 in. 74” $\frac{3}{4}$ x 39” $\frac{3}{4}$ x h 32” $\frac{3}{4}$ – hs 17” $\frac{3}{4}$ • yd. 7.20

COM	3.261,00
L	3.397,00
T	3.561,00
S	3.697,00
Z	3.860,00
K	3.996,00
PS	4.541,00
PF	5.055,00
PX	5.876,00
PA	6.646,00



NIKY00DIVA260
 I Divano 3 posti cm. 260.
 E 3 seater sofa cm. 260.
 F Canapé 3 places cm. 260.
 D Sofa 3-sitzig cm. 260.
 S Sofá de 3 plazas 260.

cm. 260 x 100 x h 83 – hs 43.5 • mt. 12.45
 in. 102” $\frac{3}{4}$ x 39” $\frac{3}{4}$ x h 32” $\frac{3}{4}$ – hs 17” $\frac{3}{4}$ • yd. 13.60

COM	4.368,00
L	4.625,00
T	4.933,00
S	5.189,00
Z	5.497,00
K	5.755,00
PS	6.666,00
PF	7.597,00
PX	9.088,00
PA	10.484,00



NIKY00CENT220
 I Divano senza braccioli cm. 220.
 E Sofa without arms cm. 220.
 F Canapé sans accoudoirs cm. 220.
 D Sofa ohne Armlehnen cm. 220.
 S Sofá sin brazos cm. 220.

cm. 220 x 100 x h 83 – hs 43.5 • mt. 9.35
 in. 86” $\frac{3}{4}$ x 39” $\frac{3}{4}$ x h 32” $\frac{3}{4}$ – hs 17” $\frac{3}{4}$ • yd. 10.25

COM	3.747,00
L	3.941,00
T	4.173,00
S	4.365,00
Z	4.597,00
K	4.791,00
PS	5.486,00
PF	6.190,00
PX	7.317,00
PA	8.373,00



NIKY00D240BDX
 I Divano 3 posti cm. 240, con bracciolo destro.
 E 3 seater sofa cm. 240, with right arm.
 F Canapé 3 places cm. 240, avec accoudoir droit.
 D Sofa 3-sitzig cm. 240, mit rechter Armlehne.
 S Sofá de 3 plazas 240, con brazo derecho.

cm. 240 x 100 x h 83 – hs 43.5 • mt. 10.90
 in. 94” $\frac{3}{4}$ x 39” $\frac{3}{4}$ x h 32” $\frac{3}{4}$ – hs 17” $\frac{3}{4}$ • yd. 11.90

COM	4.073,00
L	4.298,00
T	4.568,00
S	4.793,00
Z	5.062,00
K	5.287,00
PS	6.091,00
PF	6.909,00
PX	8.217,00
PA	9.444,00

NIKY - Design Daniele Lo Scalzo Moscheri



NIKY00D240BSX

I Divano 3 posti cm. 240, con bracciolo sinistro.
 E 3 seater sofa cm. 240, with left arm.
 F Canapé 3 places cm. 240, avec accoudoir gauche.
 D Sofa 3-sitzig cm. 240, mit linker Armlehne.
 S Sofá de 3 plazas 240, con brazo izquierdo.

cm. 240 x 100 x h 83 – hs 43.5 • mt. 10.90
 in. 94”½ x 39”¾ x h 32”¾ – hs 17”¾ • yd. 11.90

COM	4.073,00
L	4.298,00
T	4.568,00
S	4.793,00
Z	5.062,00
K	5.287,00
PS	6.091,00
PF	6.909,00
PX	8.217,00
PA	9.444,00



NIKY00D255ADX

I Divano 3 posti cm. 255, con angolo destro.
 E 3 seater sofa cm. 255, with right angle.
 F Canapé 3 places cm. 255, avec angle droit.
 D Sofa 3-sitzig cm. 255, mit Winkel rechts.
 S Sofá de 3 plazas 255, con rincón derecho.

cm. 255 x 100 x h 83 – hs 43.5 • mt. 11.65
 in. 100”¾ x 39”¾ x h 32”¾ – hs 17”¾ • yd. 12.75

COM	4.193,00
L	4.433,00
T	4.723,00
S	4.964,00
Z	5.252,00
K	5.493,00
PS	6.359,00
PF	7.236,00
PX	8.639,00
PA	9.953,00



NIKY00D255ASX

I Divano 3 posti cm. 255, con angolo sinistro.
 E 3 seater sofa cm. 255, with left angle.
 F Canapé 3 places cm. 255, avec angle gauche.
 D Sofa 3-sitzig cm. 255, mit Winkel links.
 S Sofá de 3 plazas 255, con rincón izquierdo.

cm. 255 x 100 x h 83 – hs 43.5 • mt. 11.65
 in. 100”¾ x 39”¾ x h 32”¾ – hs 17”¾ • yd. 12.75

COM	4.193,00
L	4.433,00
T	4.723,00
S	4.964,00
Z	5.252,00
K	5.493,00
PS	6.359,00
PF	7.236,00
PX	8.639,00
PA	9.953,00



NIKY00B275ADX

I Divano 3 posti cm. 275, con bracciolo sinistro ed angolo destro.
 E 3 seater sofa cm. 275, with left arm and right angle.
 F Canapé 3 places cm. 275, avec accoudoir gauche et angle droite.
 D Sofa 3-sitzig cm. 275, mit linker Armlehne und Winkel rechts.
 S Sofá de 3 plazas 275, con brazo izquierdo y rincón derecho.

cm. 275 x 100 x h 83 – hs 43.5 • mt. 13.20
 in. 108”¾ x 39”¾ x h 32”¾ – hs 17”¾ • yd. 14.45

COM	4.493,00
L	4.766,00
T	5.093,00
S	5.365,00
Z	5.693,00
K	5.965,00
PS	6.939,00
PF	7.929,00
PX	9.514,00
PA	10.999,00



NIKY00B275ASX

I Divano 3 posti cm. 275, con bracciolo destro ed angolo sinistro.
 E 3 seater sofa cm. 275, with right arm and left angle.
 F Canapé 3 places cm. 275, avec accoudoir droit et angle gauche.
 D Sofa 3-sitzig cm. 275, mit rechter Armlehne und Winkel links.
 S Sofá de 3 plazas 275, con brazo derecho y rincón izquierdo.

cm. 275 x 100 x h 83 – hs 43.5 • mt. 13.20
 in. 108”¾ x 39”¾ x h 32”¾ – hs 17”¾ • yd. 14.45

COM	4.493,00
L	4.766,00
T	5.093,00
S	5.365,00
Z	5.693,00
K	5.965,00
PS	6.939,00
PF	7.929,00
PX	9.514,00
PA	10.999,00

NIKY - Design Daniele Lo Scalzo Moscheri



NIKY00CH225DX

I Chaiselongue destra cm. 225.
E Right chaiselongue cm. 225.
F Dormeuse droite cm. 225.
D Rechte Dormeuse cm. 225.
S Chaise longue derecha cm. 225.

cm. 225 x 100 x h 83 – hs 43.5 • mt. 9.25
in. 88⁷/₈ x 39³/₈ x h 32⁷/₈ – hs 17⁷/₈ • yd. 10.10

COM	3.726,00
L	3.916,00
T	4.145,00
S	4.335,00
Z	4.565,00
K	4.756,00
PS	5.445,00
PF	6.140,00
PX	7.251,00
PA	8.294,00



NIKY00CH225SX

I Chaiselongue sinistra cm. 225.
E Left chaiselongue cm. 225.
F Dormeuse gauche cm. 225.
D Linke Dormeuse cm. 225.
S Chaise longue izquierda cm. 225.

cm. 225 x 100 x h 83 – hs 43.5 • mt. 9.25
in. 88⁷/₈ x 39³/₈ x h 32⁷/₈ – hs 17⁷/₈ • yd. 10.10

COM	3.726,00
L	3.916,00
T	4.145,00
S	4.335,00
Z	4.565,00
K	4.756,00
PS	5.445,00
PF	6.140,00
PX	7.251,00
PA	8.294,00



NIKY00PE220DX

I Penisola lineare destra cm. 220.
E Right linear chaiselongue cm. 220.
F Dormeuse linéaire droite cm. 220.
D Rechte lineare Dormeuse cm. 220.
S Chaise longue lineal derecha cm. 220.

cm. 220 x 100 x h 83 – hs 43.5 • mt. 7.70
in. 86³/₈ x 39³/₈ x h 32⁷/₈ – hs 17⁷/₈ • yd. 8.40

COM	3.526,00
L	3.684,00
T	3.875,00
S	4.035,00
Z	4.225,00
K	4.384,00
PS	4.966,00
PF	5.547,00
PX	6.477,00
PA	7.349,00



NIKY00PE220SX

I Penisola lineare sinistra cm. 220.
E Left linear chaiselongue cm. 220.
F Dormeuse linéaire gauche cm. 220.
D Linke lineare Dormeuse cm. 220.
S Chaise longue lineal izquierda cm. 220

cm. 220 x 100 x h 83 – hs 43.5 • mt. 7.70
in. 86³/₈ x 39³/₈ x h 32⁷/₈ – hs 17⁷/₈ • yd. 8.40

COM	3.526,00
L	3.684,00
T	3.875,00
S	4.035,00
Z	4.225,00
K	4.384,00
PS	4.966,00
PF	5.547,00
PX	6.477,00
PA	7.349,00



NIKY00DORM143

I Penisola lineare extralarge.
E Linear chaiselongue extralarge.
F Dormeuse linéaire extralarge.
D Lineare Dormeuse Extralarge.
S Chaise longue lineal extralarge.

cm. 143 x 85 x h 83 – hs 43.5 • mt. 5.50
in. 56³/₈ x 39³/₈ x h 32⁷/₈ – hs 17⁷/₈ • yd. 6.00

COM	2.683,00
L	2.796,00
T	2.932,00
S	3.046,00
Z	3.183,00
K	3.296,00
PS	3.686,00
PF	4.095,00
PX	4.749,00
PA	5.362,00

NIKY00SUPBASE

I Supplemento per base in noce canaletto.
E Extra charge for base in black walnut wood.
F Supplément pour base en noyer d'Amérique.
D Mehrpreis fuer Gestell in amricanische Nussbaumholz.
S Suplemento para base en nogal americano.

809,00

NIKY - Design Daniele Lo Scalzo Moscheri



NIKY00MOBTERM

I Mobile basso terminale in noce canaletto.
 E Low terminal cabinet in black walnut wood.
 F Meuble bas final en noyer d'Amérique.
 D Ende niedrige Schrank in Amerikanische Nussbaumholz.
 S Meuble bajo final en nogal americano.

2.463,00

cm. 80 x 95 x h 30
 in. 31¹/₂ x 37³/₈ x h 11³/₈

NIKY00VASSOIO

I Vassoio in pelle per mobile.
 E Leather tray for cabinet.
 F Plateau en cuir souple pour meuble.
 D Tablett in Leder fuer Schrank.
 S Bandeja en piel para meuble.

CV 718,00
 CF 615,00
 CS 485,00
 PA 682,00
 PX 604,00
 PF 521,00
 PS 469,00

NIKY - Design Daniele Lo Scalzo Moscheri



Tavolini. La struttura è in legno massello di noce canaletto. I piani sono disponibili in: a) marmo; b) cristallo bronzato; c) in pannello nobilitato rivestito in cuoio o in pelle. E' disponibile anche un tavolino monolitico in marmo.

Low tables. The frame of the low tables is in solid black walnut heartwood. The tops are available in: a) marble; b) bronzed glass; c) in melamine coated panel covered in saddle leather or leather. It is available also a low table completely in marble.



NIKY00TAQUA90

I Tavolino cm. 90x90 in marmo Bardiglio.
 E Coffee table cm. 90x90 in Bardiglio marble.
 F Table basse cm. 90x90 en marbre Bardiglio.
 D Tisch cm. 90x90 in Bardiglio Marmor.
 S Mesa centro cm. 90x90 en mármol Bardiglio.

3.400,00

cm. 90 x 90 x h 24
 in. 35³/₈ x 35³/₈ x h 9³/₈



NIKY00TA060CR

I Tavolino Ø cm. 60 in noce canaletto e piano in cristallo bronzato.
 E Coffee table Ø cm. 60 in black walnut wood with top in bronzed glass.
 F Table basse Ø cm. 60 en noyer d'Amérique et plan en verre bronzé.
 D Tisch Ø cm. 60 in Amerikanische Nussbaumholz und Platte in bronziertem Glas.
 S Mesa centro Ø cm. 60 en nogal americano y plan en cristal bronceado.

899,00

cm. 60 x 60 x h 44
 in. 23³/₈ x 23³/₈ x h 17³/₈

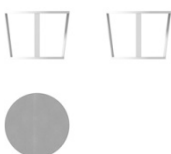

NIKY00TA060CU

I Tavolino Ø cm. 60 in noce canaletto e piano in pelle o cuoio.
 E Coffee table Ø cm. 60 in black walnut wood with top in leather or saddle leather.
 F Table basse Ø cm. 60 en noyer d'Amérique et plan en cuir souple ou cuir épais.
 D Tisch Ø cm. 60 in Amerikanische Nussbaumholz und Platte in Leder oder Rindleder.
 S Mesa centro Ø cm. 60 en nogal americano y plan en piel o en cuero.

CV 1.044,00
 CF 990,00
 CS 922,00
 PA 1.026,00
 PX 985,00
 PF 941,00
 PS 914,00

cm. 60 x 60 x h 44
 in. 23³/₈ x 23³/₈ x h 17³/₈



NIKY00TA060MB

I Tavolino Ø cm. 60 in noce canaletto e piano in marmo Bardiglio.
 E Coffee table Ø cm. 60 in black walnut wood with top in Bardiglio marble.
 F Table basse Ø cm. 60 en noyer d'Amérique et plan en marbre Bardiglio.
 D Tisch Ø cm. 60 in Amerikanische Nussbaumholz und Platte in Bardiglio Marmor.
 S Mesa centro Ø cm. 60 en nogal americano y plan en mármol Bardiglio.

1.217,00

cm. 60 x 60 x h 45
 in. 23³/₈ x 23³/₈ x h 17³/₈

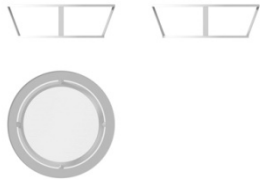

NIKY00TA100CR

I Tavolino Ø cm. 100 in noce canaletto e piano in cristallo bronzato.
 E Coffee table Ø cm. 100 in black walnut wood with top in bronzed glass.
 F Table basse Ø cm. 100 en noyer d'Amérique et plan en verre bronzé.
 D Tisch Ø cm. 100 in Amerikanische Nussbaumholz und Platte in bronziertem Glas.
 S Mesa centro Ø cm. 100 en nogal americano y plan en cristal bronceado.

1.463,00

cm. 100 x 100 x h 31
 in. 39³/₈ x 39³/₈ x h 12³/₈

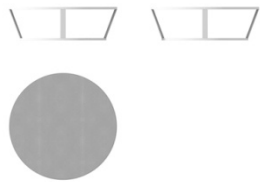

NIKY00TA100CU

I Tavolino Ø cm. 100 in noce canaletto e piano in pelle o cuoio.
 E Coffee table Ø cm. 100 in black walnut wood with top in leather or saddle leather.
 F Table basse Ø cm. 100 en noyer d'Amérique et plan en cuir souple ou cuir épais.
 D Tisch Ø cm. 100 in Amerikanische Nussbaumholz und Platte in Leder oder Rindleder.
 S Mesa centro Ø cm. 100 en nogal americano y plan en piel o en cuero.

CV 1.708,00
 CF 1.581,00
 CS 1.421,00
 PA 1.663,00
 PX 1.568,00
 PF 1.467,00
 PS 1.403,00

cm. 100 x 100 x h 31
 in. 39³/₈ x 39³/₈ x h 12³/₈



NIKY00TA100MB

I Tavolino Ø cm. 100 in noce canaletto e piano in marmo Bardiglio.
 E Coffee table Ø cm. 100 in black walnut wood with top in Bardiglio marble.
 F Table basse Ø cm. 100 en noyer d'Amérique et plan en marbre Bardiglio.
 D Tisch Ø cm. 100 in Amerikanische Nussbaumholz und Platte in Bardiglio Marmor.
 S Mesa centro Ø cm. 100 en nogal americano y plan en mármol Bardiglio.

2.248,00

cm. 100 x 100 x h 32
 in. 39³/₈ x 39³/₈ x h 12³/₈

OYSTER - Design Mauro Lipparini



Struttura. Il guscio inferiore è realizzato in poliuretano compatto Baydur® CSP realizzato in stampo. Nella versione in cuoio il guscio inferiore è fissato a un guscio superiore sempre in poliuretano compatto Baydur® CSP realizzato in stampo accoppiato a una lastra di poliuretano schiumata a freddo; in questa versione la seduta è di tipo semi-rigido. Nella versione in pelle o tessuto, il guscio inferiore è inserito in un nuovo stampo per avere un'imbottitura in poliuretano schiumato a freddo; in questo caso la seduta è di tipo morbido.

La schiuma poliuretanicca soddisfa la classe 1 IM di resistenza al fuoco secondo la legge italiana ed è disponibile anche secondo altri standard internazionali.

Base. Basamento in acciaio girevole a 4 razze con pistone a gas. Disponibile in finitura cromata o verniciata a polveri epossidiche in colore RAL a scelta.

Rivestimento. Disponibile in cuoio, tessuto e pelle; non sfoderabile.

Frame. The lower shell is rigid polyurethane Baydur® CSP made in mould. In the saddle leather version the lower shell is fixed to an upper shell in rigid polyurethane Baydur® CSP made in mould and coupled with a sheet of cold formed polyurethane foam; in this case the seat is semi-rigid. In the leather or fabric version, the lower shell is inserted into a new mould to have an upholstery with cold formed polyurethane foam; in this case the seat is soft.

The foam complies with the Italian Classe 1IM fire resistant law and is available on request for other international standards.

Base. Four star swivel steel base with gas-piston. Available chromed or epoxy powder painted in RAL colors of your choice.

Covers. Available in saddle leather, fabric or leather; non removable covers.



OYSTERPOLCUOI

I Poltrona relax completamente rivestita in cuoio. Basamento cromato o verniciato.
E Relax armchair completely covered in saddle leather. Chromed or varnished base.
F Fauteuil relax complètement recouvert en cuir épais. Pietément chromé ou verni.
D Relax Sessel komplett Rindleder bezogen mit verchromtem oder lackiertem Fuss.
S Sillón relax completamente tapizado en cuero. Base giratoria cromada o barnizada.

CF 4.233,00

cm. 84 x 96 x h 89 – hs 28/40
 in. 33” $\frac{3}{4}$ x 37” $\frac{3}{4}$ x h 35” – hs 11” $\frac{15}{16}$ ”



OYSTERPOLIMBO

I Poltrona relax imbottita con basamento cromato o verniciato.
E Soft relax armchair with chromed or varnished base.
F Fauteuil relax rembourré avec pietément chromé ou verni.
D Gepolstert relax Sessel mit verchromtem oder lackiertem Fuss.
S Sillón relax relleno, con base giratoria cromada o barnizada.

COM 2.580,00
 L 2.652,00
 T 2.738,00
 S 2.809,00
 Z 2.894,00
 K 2.965,00
 PS 3.338,00
 PF 3.624,00
 PX 3.895,00
 PA 4.304,00

cm. 84 x 96 x h 89 – hs 28/40 • mt. 3.30
 in. 33” $\frac{3}{4}$ x 37” $\frac{3}{4}$ x h 35” – hs 11” $\frac{15}{16}$ ” • yd. 3.60



OYSTERPUFCUOI

I Pouff completamente rivestito in cuoio. Basamento cromato o verniciato.
E Ottoman completely covered in saddle leather. Chromed or varnished base.
F Pouf complètement recouvert en cuir épais. Pietément chromé ou verni.
D Hocker komplett Rindlederbezogen. Verchromtem oder lackiertem Fuss.
S Pouf completamente tapizado en cuero con base cromada o barnizada.

CV 1.950,00
 CF 1.786,00
 CS 1.580,00

cm. 64 x 60 x h 36.5 – hs 36.5
 in. 25” $\frac{3}{4}$ x 23” $\frac{3}{4}$ x h 14” $\frac{3}{4}$ – hs 14” $\frac{3}{4}$ ”



OYSTERPUFIMBO

I Pouff imbottito con basamento cromato o verniciato.
E Soft ottoman with chromed or varnished base.
F Pouf rembourré avec pietément chromé ou verni.
D Gepolstert Hocker mit verchromtem oder lackiertem Fuss.
S Pouf relleno, con base cromada o barnizada.

COM 1.277,00
 L 1.312,00
 T 1.353,00
 S 1.387,00
 Z 1.430,00
 K 1.464,00
 PS 1.658,00
 PF 1.792,00
 PX 2.083,00
 PA 2.303,00

cm. 64 x 60 x h 36.5 – hs 36.5 • mt. 1.75
 in. 25” $\frac{3}{4}$ x 23” $\frac{3}{4}$ x h 14” $\frac{3}{4}$ – hs 14” $\frac{3}{4}$ ” • yd. 1.90

OYSTER - Design Mauro Lipparini

OYSTERCUSC020

I Cuscinetto.
E Small cushion.
F Petit coussin.
D Kissen.
S Cojín.

cm. 35 x 28 x h 6 • mt. 0.30
in. 13³/₄ x 11¹/₄ x h 2³/₄ • yd. 0.35

COM	66,00
L	71,00
T	76,00
S	81,00
Z	87,00
K	92,00
PS	92,00
PF	104,00
PX	123,00
PA	140,00

OYSTER - Design Mauro Lipparini



Base. Basamento in acciaio a 4 razze. Disponibile in finitura cromata o verniciata a polveri epossidiche in colore RAL a scelta.

Piano. Disponibile in: a) cristallo retro verniciato colore bianco; b) pannello nobilitato rivestito in cuoio; c) laminato colore bianco o nero; d) marmo.

Base. Four star steel base. Available chromed or epoxy powder painted in RAL colors of your choice.

Top. Available in: a) glass white painted underneath; b) melamine coated panel covered in saddle leather; c) white or black laminate coated panel; d) marble.

I Tavolino Ø cm. 40 con piedi cromati o verniciati. Disponibile in: cristallo retroverniciato temperato bianco (CR); cuoio (CU); laminato bianco o nero (LA); marmo Calacatta Oro (MC); marmo Marquina Nero o Bianco Carrara Gioia (MM).

E Coffee table Ø cm. 40 with chromed or varnished legs. Available in: white varnished tempered glass (CR); saddle leather (CU); white or black laminate coated panel (LA); Calacatta Oro marble (MC); Black Marquina or White Carrara Gioia marble (MM).

F Table basse Ø cm. 40 avec pied chromé ou verni. Disponible en: cristal blanc verni et trempé (CR); cuir (CU); laminé blanc ou noire (LA); marbre Calacatta Oro (MC); marbre noir Marquina ou blanc Carrara Gioia (MM).

D Tisch Ø cm. 40 mit verchromtem oder lackiertem Fuss. Lieferbar mit: gehärtetem und weiss Glas lackiert (CR); Rindleder (CU); weiss oder schwarz Kunststoff (LA); Calacatta Oro Marmor (MC); Marmor Marquina schwarz oder weissen Marmor Carrara Gioia (MM).

S Mesa centro Ø cm. 40 con patas cromadas o pintadas. Disponible en: cristal templado pintado blanco (CR); cuero (CU); laminado blanco o negro (LA); mármol Calacatta Oro (MC); mármol Marquina negro o bien mármol blanco Carrara Gioia (MM).

cm. 40 x 40 x h 17
in. 15³/₄ x 15³/₄ x h 6³/₄

OYSTERT4017CR



852,00

OYSTERT4017CU



CV 682,00
CF 640,00
CS 587,00

OYSTERT4017LA



514,00

OYSTERT4017MC



857,00

OYSTERT4017MM



741,00

OYSTER - Design Mauro Lipparini

I Tavolino Ø cm. 40 con piedi cromati o verniciati. Disponibile in: cristallo retroverniciato temperato bianco (CR); cuoio (CU); laminato bianco o nero (LA); marmo Calacatta Oro (MC); marmo Marquina Nero o Bianco Carrara Gioia (MM).

E Coffee table Ø cm. 40 with chromed or varnished legs. Available in: white varnished tempered glass (CR); saddle leather (CU); white or black laminate coated panel (LA); Calacatta Oro marble (MC); Black Marquina or White Carrara Gioia marble (MM).

F Table basse Ø cm. 40 avec pied chromé ou verni. Disponible en: cristal blanc verni et trempé (CR); cuir (CU); laminé blanc ou noire (LA); marbre Calacatta Oro (MC); marbre noir Marquina ou blanc Carrara Gioia (MM).

D Tisch Ø cm. 40 mit verchromtem oder lackiertem Fuss. Lieferbar mit: gehärtetem und weiss Glas lackiert (CR); Rindleder (CU); weiss oder schwarz Kunststoff (LA); Calacatta Oro Marmor (MC); Marmor Marquina schwarz oder weissen Marmor Carrara Gioia (MM).

S Mesa centro Ø cm. 40 con patas cromadas o pintadas. Disponible en: cristal templado pintado blanco (CR); cuero (CU); laminado blanco o negro (LA); mármol Calacatta Oro (MC); mármol Marquina negro o bien mármol blanco Carrara Gioia (MM).

cm. 40 x 40 x h 36

in. 15³/₄ x 15³/₄ x h 14¹/₄

OYSTERT4036CR



883,00

OYSTERT4036CU



CV 709,00
CF 665,00
CS 612,00

OYSTERT4036LA



538,00

OYSTERT4036MC



887,00

OYSTERT4036MM



768,00

I Tavolino Ø cm. 40 con piedi cromati o verniciati. Disponibile in: cristallo retroverniciato temperato bianco (CR); cuoio (CU); laminato bianco o nero (LA); marmo Calacatta Oro (MC); marmo Marquina Nero o Bianco Carrara Gioia (MM).

E Coffee table Ø cm. 40 with chromed or varnished legs. Available in: white varnished tempered glass (CR); saddle leather (CU); white or black laminate coated panel (LA); Calacatta Oro marble (MC); Black Marquina or White Carrara Gioia marble (MM).

F Table basse Ø cm. 40 avec pied chromé ou verni. Disponible en: cristal blanc verni et trempé (CR); cuir (CU); laminé blanc ou noire (LA); marbre Calacatta Oro (MC); marbre noir Marquina ou blanc Carrara Gioia (MM).

D Tisch Ø cm. 40 mit verchromtem oder lackiertem Fuss. Lieferbar mit: gehärtetem und weiss Glas lackiert (CR); Rindleder (CU); weiss oder schwarz Kunststoff (LA); Calacatta Oro Marmor (MC); Marmor Marquina schwarz oder weissen Marmor Carrara Gioia (MM).

S Mesa centro Ø cm. 40 con patas cromadas o pintadas. Disponible en: cristal templado pintado blanco (CR); cuero (CU); laminado blanco o negro (LA); mármol Calacatta Oro (MC); mármol Marquina negro o bien mármol blanco Carrara Gioia (MM).

cm. 40 x 40 x h 54

in. 15³/₄ x 15³/₄ x h 21³/₄

OYSTERT4054CR



885,00

OYSTERT4054CU



CV 708,00
CF 664,00
CS 609,00

OYSTERT4054LA



534,00

OYSTERT4054MC



890,00

OYSTERT4054MM



768,00

I Tavolino Ø cm. 60 con piedi cromati o verniciati. Disponibile in: cristallo retroverniciato temperato bianco (CR); cuoio (CU); laminato bianco o nero (LA); marmo Calacatta Oro (MC); marmo Marquina Nero o Bianco Carrara Gioia (MM).

E Coffee table Ø cm. 60 with chromed or varnished legs. Available in: white varnished tempered glass (CR); saddle leather (CU); white or black laminate coated panel (LA); Calacatta Oro marble (MC); Black Marquina or White Carrara Gioia marble (MM).

F Table basse Ø cm. 60 avec pied chromé ou verni. Disponible en: cristal blanc verni et trempé (CR); cuir (CU); laminé blanc ou noire (LA); marbre Calacatta Oro (MC); marbre noir Marquina ou blanc Carrara Gioia (MM).

D Tisch Ø cm. 60 mit verchromtem oder lackiertem Fuss. Lieferbar mit: gehärtetem und weiss Glas lackiert (CR); Rindleder (CU); weiss oder schwarz Kunststoff (LA); Calacatta Oro Marmor (MC); Marmor Marquina schwarz oder weissen Marmor Carrara Gioia (MM).

S Mesa centro Ø cm. 60 con patas cromadas o pintadas. Disponible en: cristal templado pintado blanco (CR); cuero (CU); laminado blanco o negro (LA); mármol Calacatta Oro (MC); mármol Marquina negro o bien mármol blanco Carrara Gioia (MM).

cm. 60 x 60 x h 17

in. 23³/₄ x 23³/₄ x h 6³/₄

OYSTERT6017CR



947,00

OYSTERT6017CU



CV 902,00
CF 821,00
CS 720,00

OYSTERT6017LA



552,00

OYSTERT6017MC



1.224,00

OYSTERT6017MM



967,00

OYSTER - Design Mauro Lipparini

I Tavolino Ø cm. 60 con piedi cromati o verniciati. Disponibile in: cristallo retroverniciato temperato bianco (CR); cuoio (CU); laminato bianco o nero (LA); marmo Calacatta Oro (MC); marmo Marquina Nero o Bianco Carrara Gioia (MM).

E Coffee table Ø cm. 60 with chromed or varnished legs. Available in: white varnished tempered glass (CR); saddle leather (CU); white or black laminate coated panel (LA); Calacatta Oro marble (MC); Black Marquina or White Carrara Gioia marble (MM).

F Table basse Ø cm. 60 avec pied chromé ou verni. Disponible en: cristal blanc verni et trempé (CR); cuir (CU); laminé blanc ou noire (LA); marbre Calacatta Oro (MC); marbre noir Marquina ou blanc Carrara Gioia (MM).

D Tisch Ø cm. 60 mit verchromtem oder lackiertem Fuss. Lieferbar mit: gehärtetem und weiss Glas lackiert (CR); Rindleder (CU); weiss oder schwarz Kunststoff (LA); Calacatta Oro Marmor (MC); Marmor Marquina schwarz oder weissen Marmor Carrara Gioia (MM).

S Mesa centro Ø cm. 60 con patas cromadas o pintadas. Disponible en: cristal templado pintado blanco (CR); cuero (CU); laminado blanco o negro (LA); mármol Calacatta Oro (MC); mármol Marquina negro o bien mármol blanco Carrara Gioia (MM).

cm. 60 x 60 x h 36

in. 23 3/8 x 23 3/8 x h 14 1/4

OYSTERT6036CR



965,00

OYSTERT6036CU



CV 920,00
CF 837,00
CS 734,00

OYSTERT6036LA



562,00

OYSTERT6036MC



1.246,00

OYSTERT6036MM



986,00

I Tavolino Ø cm. 60 con piedi cromati o verniciati. Disponibile in: cristallo retroverniciato temperato bianco (CR); cuoio (CU); laminato bianco o nero (LA); marmo Calacatta Oro (MC); marmo Marquina Nero o Bianco Carrara Gioia (MM).

E Coffee table Ø cm. 60 with chromed or varnished legs. Available in: white varnished tempered glass (CR); saddle leather (CU); white or black laminate coated panel (LA); Calacatta Oro marble (MC); Black Marquina or White Carrara Gioia marble (MM).

F Table basse Ø cm. 60 avec pied chromé ou verni. Disponible en: cristal blanc verni et trempé (CR); cuir (CU); laminé blanc ou noire (LA); marbre Calacatta Oro (MC); marbre noir Marquina ou blanc Carrara Gioia (MM).

D Tisch Ø cm. 60 mit verchromtem oder lackiertem Fuss. Lieferbar mit: gehärtetem und weiss Glas lackiert (CR); Rindleder (CU); weiss oder schwarz Kunststoff (LA); Calacatta Oro Marmor (MC); Marmor Marquina schwarz oder weissen Marmor Carrara Gioia (MM).

S Mesa centro Ø cm. 60 con patas cromadas o pintadas. Disponible en: cristal templado pintado blanco (CR); cuero (CU); laminado blanco o negro (LA); mármol Calacatta Oro (MC); mármol Marquina negro o bien mármol blanco Carrara Gioia (MM).

cm. 60 x 60 x h 54

in. 23 3/8 x 23 3/8 x h 21 1/4

OYSTERT6054CR



1.093,00

OYSTERT6054CU



CV 1.049,00
CF 967,00
CS 865,00

OYSTERT6054LA



695,00

OYSTERT6054MC



1.372,00

OYSTERT6054MM



1.114,00

I Tavolino Ø cm. 100 con piedi cromati o verniciati. Disponibile in: cristallo retroverniciato temperato bianco (CR); cuoio (CU); laminato bianco o nero (LA); marmo Calacatta Oro (MC); marmo Marquina Nero o Bianco Carrara Gioia (MM).

E Coffee table Ø cm. 100 with chromed or varnished legs. Available in: white varnished tempered glass (CR); saddle leather (CU); white or black laminate coated panel (LA); Calacatta Oro marble (MC); Black Marquina or White Carrara Gioia marble (MM).

F Table basse Ø cm. 100 avec pied chromé ou verni. Disponible en: cristal blanc verni et trempé (CR); cuir (CU); laminé blanc ou noire (LA); marbre Calacatta Oro (MC); marbre noir Marquina ou blanc Carrara Gioia (MM).

D Tisch Ø cm. 100 mit verchromtem oder lackiertem Fuss. Lieferbar mit: gehärtetem und weiss Glas lackiert (CR); Rindleder (CU); weiss oder schwarz Kunststoff (LA); Calacatta Oro Marmor (MC); Marmor Marquina schwarz oder weissen Marmor Carrara Gioia (MM).

S Mesa centro Ø cm. 100 con patas cromadas o pintadas. Disponible en: cristal templado pintado blanco (CR); cuero (CU); laminado blanco o negro (LA); mármol Calacatta Oro (MC); mármol Marquina negro o bien mármol blanco Carrara Gioia (MM).

cm. 100 x 100 x h 27

in. 39 3/8 x 39 3/8 x h 10 3/8

OYSTERTA100CR



1.409,00

OYSTERTA100CU



CV 1.452,00
CF 1.275,00
CS 1.053,00

OYSTERTA100LA



705,00

OYSTERTA100MC



2.469,00

OYSTERTA100MM



1.750,00

OYSTER LIGHT - Design Mauro Lipparini



Struttura. La poltrona è costituita da due fogli di cuoio termoformati in stampo; questi sono poi incollati fra loro dopo avere interposto fra di loro una struttura di alluminio.

Base. Basamento tondino d'acciaio cromato.

Rivestimento. Disponibile in cuoio.

Frame. The armchair is formed by two sheets of saddle leather thermoformed into a mould; these sheets are one to the other after having interposed an aluminum frame.

Base. Chromed steel rod frame.

Covers. Available in saddle leather.



OLIGHTPOLTRON

I Poltrona relax in cuoio con struttura in acciaio cromato

E Relax armchair in saddle leather with base in chromed steel.

F Fauteuil relax en cuir épais avec piétement chromé.

D Relax Sessel in Rindleder mit verchromtem Fuss.

S Sillón relax completamente en cuero. Base cromada.

CF 2.775,00

cm. 75 x 85 x h 94 – hs 30/40

in. 29¹/₂ x 33¹/₂ x h 37¹/₂ – hs 11³/₄/15¹/₄

PAPIER - Design Matteo Nunziati



Struttura. In pannello multistrato di faggio curvato in stampo e laccato colore nero opaco. Esternamente rivestito in cuoio.

Piano. Piano superiore e inferiore in MDF laccato nero opaco e superiormente rivestito in cuoio.

Frame. In beech plywood panels curved into a mould and black color matt lacquered. Outside covered in saddle leather.

Top. Top and base in MDF black color matt lacquered and covered in saddle leather on the top only.

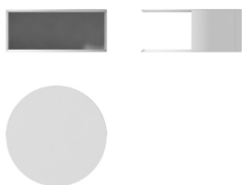

PAPIERTAVO090

- I Tavolino in cuoio Ø cm. 91.
- E Coffee table in saddle leather Ø cm. 91.
- F Table basse en cuir Ø cm. 91.
- D Tisch in Rindleder Ø cm. 91.
- S Mesa centro en cuero Ø cm. 91.

CV 1.955,00
CF 1.782,00
CS 1.566,00

cm. 91 x 91 x h 38.5
in. 35³/₄ x 35³/₄ x h 15¹/₂



PAPIERTAVO060

- I Tavolino in cuoio Ø cm. 60.5.
- E Coffee table in saddle leather Ø cm. 60.5.
- F Table basse en cuir Ø cm. 60.5.
- D Tisch in Rindleder Ø cm. 60.5.
- S Mesa centro en cuero Ø cm. 60.5.

CV 1.366,00
CF 1.270,00
CS 1.152,00

cm. 60.5 x 60.5 x h 32
in. 23³/₄ x 23³/₄ x h 12³/₄



PAPIERTAVO035

- I Tavolino in cuoio Ø cm. 35.
- E Coffee table in saddle leather Ø cm. 35.
- F Table basse en cuir Ø cm. 35.
- D Tisch in Rindleder Ø cm. 35.
- S Mesa centro en cuero Ø cm. 35.

CV 997,00
CF 954,00
CS 900,00

cm. 35 x 35 x h 48.5
in. 13³/₄ x 13³/₄ x h 19¹/₂

PAPILLON - Design Alessandro Dubini



Struttura. Lo schienale e il sedile hanno una struttura in tubolare d'acciaio; il molleggio è garantito da cinghie elastiche in polipropilene e lattice naturale fissate alla struttura del sedile. Le due strutture separate di schienale e sedile sono annegate in poliuretano espanso, schiumato a freddo in due opportuni stampi e rivestite con fibre di poliestere. La schiuma poliuretanicca soddisfa la classe 1 IM di resistenza al fuoco secondo la legge italiana ed è disponibile anche secondo altri standard internazionali.

Base. Quattro piedini in PVC nero.

Rivestimento. Disponibile in tessuto e pelle; non sfoderabile.

Frame. The frame of the backrest and of the seat is in tubular steel; the webbing is secured by elastic polypropylene and natural latex belts fixed to the seat frame. The two frames are embedded in cold formed polyurethane foam made in two different moulds and covered by polyester wadding. The foam complies with the Italian Classe 1IM fire resistant law and is available on request for other international standards.

Base. Four feet in black PVC.

Covers. Available in fabric or leather; non removable covers.



PAPILLPOLTRON

- I Poltrona.
- E Armchair.
- F Fauteuil.
- D Sessel.
- S Butaca.

cm. 64 x 60 x h 78 – hs 44 • mt. 3.10
in. 25¹/₄ x 23³/₈ x h 30³/₄ – hs 17³/₈ • yd. 3.40

COM	956,00
L	1.018,00
T	1.092,00
S	1.154,00
Z	1.228,00
K	1.290,00
PS	1.581,00
PF	1.802,00
PX	2.155,00
PA	2.485,00

PARK - Design Mauro Lipparini



Struttura. In pannello nobilitato rivestito in cuoio.

Piano. Piano superiore e inferiore in marmo o in pannello nobilitato rivestito in cuoio.

Frame. In melamine coated panel covered in saddle leather.

Top. Top and base in marble or in melamine coated panel covered in saddle leather.

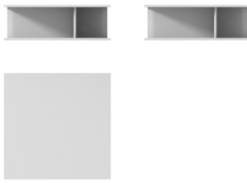

PARK00TA096CU

I Tavolino in cuoio cm 96x96.

E Coffe table covered in saddle leather cm. 96x96.

F Petit table recouverte de cuir epais cm. 96x96.

D Couchtisch in Leder bezogen cm. 96x96.

S Mesa centro tapizada en cuero cm. 96x96.

CV 2.442,00

CF 1.988,00

CS 1.420,00

cm. 96 x 96 x h 32

in. 37³/₄ x 37³/₄ x h 12³/₄

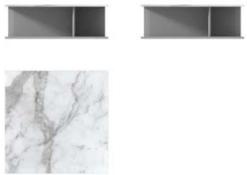

PARK00TA096ME

I Tavolino in cuoio e piani in marmo Marron Emperador cm 96x96.

E Coffe table in saddle leather and tops in marble Marron Emperador cm. 96x96.

F Petit table en cuir epais et plans en marbre Marron Emperador cm. 96x96.

D Couchtisch in Leder bezogen mit Platten in Marmor Marron Emperador cm. 96x96.

S Mesa centro tapizada en cuero con encimeras en mármol Marron Emperador cm. 96x96.

CV 3.403,00

CF 3.191,00

CS 2.925,00

cm. 96 x 96 x h 32

in. 37³/₄ x 37³/₄ x h 12³/₄



PARK00TA096CA

I Tavolino in cuoio e piani in marmo Calacatta Oro cm 96x96.

E Coffe table in saddle leather and tops in marble Calacatta Oro cm. 96x96.

F Petit table en cuir epais et plans en marbre Calacatta Oro cm. 96x96.

D Couchtisch in Leder bezogen mit Platten in Marmor Calacatta Oro cm. 96x96.

S Mesa centro tapizada en cuero con encimeras en mármol Calacatta Oro cm. 96x96.

CV 4.539,00

CF 4.326,00

CS 4.060,00

cm. 96 x 96 x h 32

in. 37³/₄ x 37³/₄ x h 12³/₄



PARK00TA140CU

I Tavolino in cuoio cm 140x70.

E Coffe table covered in saddle leather cm. 140x70.

F Petit table recouverte de cuir epais cm. 140x70.

D Couchtisch in Leder bezogen cm. 140x70.

S Mesa centro tapizada en cuero cm. 140x70.

CV 3.161,00

CF 2.534,00

CS 1.751,00

cm. 140 x 70 x h 32

in. 55¹/₂ x 27¹/₂ x h 12³/₄

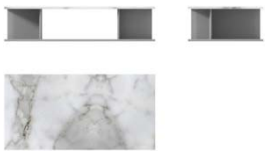

PARK00TA140ME

I Tavolino in cuoio e piani in marmo Marron Emperador cm 140x70.

E Coffe table in saddle leather and tops in marble Marron Emperador cm. 140x70.

F Petit table en cuir epais et plans en marbre Marron Emperador cm. 140x70.

D Couchtisch in Leder bezogen mit Platten in Marmor Marron Emperador cm. 140x70.

S Mesa centro tapizada en cuero con encimeras en mármol Marron Emperador cm. 140x70.

CV 3.352,00

CF 3.185,00

CS 2.977,00

cm. 140 x 70 x h 32

in. 55¹/₂ x 27¹/₂ x h 12³/₄

PARK - Design Mauro Lipparini

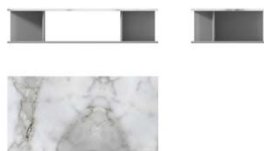

PARK00TA140CA

I Tavolino in cuoio e piani in marmo Calacatta Oro cm 140x70.

E Coffe table in saddle leather and tops in marble Calacatta Oro cm. 140x70.

F Petit table en cuir epais et plans en marbre Calacatta Oro cm. 140x70.

D Couchtisch in Leder bezogen mit Platten in Marmor Calacatta oro cm. 140x70.

S Mesa centro tapizada en cuero con encimeras en mármol Calacatta Oro cm. 140x70.

CV 4.487,00

CF 4.321,00

CS 4.113,00

cm. 140 x 70 x h 32

in. 55¹/₂ x 27¹/₂ x h 12¹/₂

PLANET - Design Daniele Lo Scalzo Moscheri



Struttura. La struttura è costituita da due gusci realizzati in poliuretano compatto Baydur® CSP realizzato in stampo. Quello esterno è rivestito direttamente in pelle. Quello interno è accoppiato a un altro guscio di poliuretano schiumato a freddo con densità di 35 kg/m³. I due gusci rigidi sono poi fissati fra loro con ganci metallici.

La schiuma poliuretanicca soddisfa la classe 1 IM di resistenza al fuoco secondo la legge italiana ed è disponibile anche secondo altri standard internazionali.

Cuscini. Il cuscino di seduta è in poliuretano espanso indeformabile con densità di 35 kg/m³ esente da CFC ricoperto da ovatta poliestere.

Base. Basamento in lastra d'acciaio rivestita da struttura in MDF laccato con meccanismo girevole d'acciaio.

Rivestimento. Disponibile in pelle; non sfoderabile.

Frame. The frame consists of two shell made in rigid polyurethane Baydur® CSP made in mould. The outside shell is covered directly in leather. The inside shell is coupled with another shell of polyurethane foam with density of 35 kg/m³ made in mould. The two rigid shells are then fixed one to the other through metal hooks.

The foam complies with the Italian Classe 1IM fire resistant law and is available on request for other international standards.

Cushions. The seat cushion is made in resilient, CFC-free polyurethane foam with density of 35 kg/m³ covered by polyester wadding.

Base. Steel sheet covered with MDF frame matt lacquered with steel swivel mechanism.

Covers. Available in leather; non removable covers.

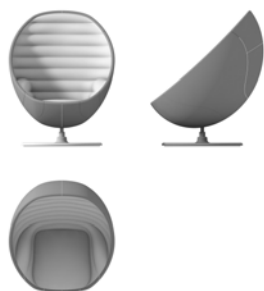

PLANETRELAX01

I Poltrona relax girevole con base verniciata in colore RAL a scelta del cliente.

E Relax armchair with swivel base varnished in RAL colour at client's choice.

F Fauteuil relax tournant avec pietément verni en couleur RAL choisi par le client.

D Drehsessel relax mit Fuss lackiertem in RAL Farbe nach Wahl.

S Sillón relax giratorio con base pintada en color RAL eligido por el cliente.

PS 5.566,00

PF 5.965,00

PX 6.604,00

PA 7.202,00

cm. 95 x 95 x h 123 – hs 45

in. 37³/₈ x 37³/₈ x h 48¹/₂ – hs 17³/₈

POT - Design Mauro Lipparini



Tavolino. Base in tubolare d'acciaio disponibile cromata o verniciata a polveri epossidiche in colore RAL a scelta. Il piano è in pannello nobilitato rivestito in cuoio.

Low tables. Base in tubular steel chromed or epoxy powder painted in RAL colors of your choice. The top is in melamine coated panel covered in saddle leather.



POT000TA100CU

I Tavolino in cuoio con piedini verniciati cm 100x100.

E Coffe table covered in saddle leather with varnished feet cm. 100x100.

F Petit table recouverte de cuir epais avec pied verni cm. 100x100.

D Couchtisch in Leder bezogen mit lackiertem Fussen cm. 100x100.

S Mesa centro tapizada en cuero con patas pintadas cm. 100x100.

CV 1.452,00

CF 1.298,00

CS 1.105,00

cm. 100 x 100 x h 27.5

in. 39"½ x 39"½ x h 10"½

POT000SUPTACR

I Supplemento per basamento cromato per ogni singolo tavolino.

E Extra charge for chromed base for every single coffee table.

F Supplément pour piétement chromé pour chaque single table basse.

D Mehrpreis fuer verchromtem Gestell fuer jede Tisch.

S Suplemento para la base cromada de cada mesa centro.

141,00

SAVILE ROW - Design Alessandro Dubini



Struttura. In multistrato di pioppo curvato in stampo. L'imbottitura della struttura è ottenuta con lastre di poliuretano espanso indeformabile a densità differenziate (25÷30 kg/m³) esente da CFC ricoperto da ovatta poliesteri. I braccioli sono imbottiti con poliuretano espanso schiumato a freddo in stampo e rivestiti in ovatta poliesteri.

Cuscini. Cuscini di seduta poliuretano espanso indeformabile con densità 40 kg/m³ esente da CFC ricoperto da ovatta poliesteri.

Base. In legno massello di noce canaletto con finitura "effetto cera".

Rivestimento. Disponibile in tessuto e pelle anche in versione combinata; sfoderabile solo per i cuscini di seduta.

Frame. In poplar plywood curved into a mould. The framework is upholstered with contoured sheets of resilient, CFC-free polyurethane foam (with density of 25÷30 kg/m³) covered by polyester wadding. The arms are upholstered in cold formed polyurethane foam made in mould and covered with polyester wadding.

Cushions. The seat cushions are in CFC-free polyurethane foam with density of 40 kg/m³ covered by polyester wadding.

Base. In solid black walnut wood with "wax effect" finish.

Covers. Available in fabric or leather also in a mixed version; removable covers only for seat cushions.



I Poltrona con struttura in cuoietto cat CS o pelle cat. PS (prezzo cat. CS), in cuoio cat CF, pelle cat. PF, PX (prezzo cat. CF) o in cuoio cat. CV, pelle cat. PA (prezzo in cat. CV). Cuscini in tessuto o pelle. Basamento in noce canaletto.

E Armchair with frame in saddle leather cat CS or leather cat. PS (price in cat. CS) or in saddle leather cat. CF or leather PF, PX (price in cat. CF) or saddle leather cat. CV or leather cat. PA (price in cat. CV). Cushions in fabric or leather. Base in black walnut wood.

F Fauteuil avec structure en cuir épais cat. CS ou cuir souple cat. PS (prix en cat. CS) ou en cuir épais cat. CF ou cuir souple cat. PF, PX (prix en cat. CF), ou en cuir épais cat. CV ou cuir souple cat. PA (prix en cat. CV). Coussins en tissu ou cuir souple. Piètement en noyer d'Amérique.

D Sessel mit Gestell in Rindleder cat. CS oder in Leder cat. PS (preis in cat. CS); in Rindleder CF oder in Leder cat. PF, PX, PA (preis in cat. CF), in Rindleder CV oder in Leder cat. PA (preis in cat. CV). Kissen in Stoff oder in Leder. Fusse in Amerikanische Nussbaumholz.

S Butaca con estructura en cuero cat. CS o piel cat. PS (precio en cat. CS) o cuero en cat. CF o piel cat. PF, PX (precio en cat. CF), o cuero en cat. CV o piel cat. PA (precio en cat. CV). Cojines en tejido o tambien in piel. Base en nogal americano.

cm. 84 x 75 x h 74 – hs 39 • mt. 3.95

in. 33" x 29" x h 29" – hs 15" • yd. 4.30

SAVILECSPO084		SAVILECFPO084		SAVILECVPO084	
	Cat. CS		Cat. CF		Cat. CV
COM	3.678,00	COM	3.894,00	COM	4.067,00
L	3.755,00	L	3.972,00	L	4.145,00
T	3.849,00	T	4.065,00	T	4.238,00
S	3.927,00	S	4.144,00	S	4.317,00
Z	4.021,00	Z	4.237,00	Z	4.410,00
K	4.098,00	K	4.315,00	K	4.488,00
PS	4.366,00	PS	4.582,00	PS	4.756,00
PF	4.647,00	PF	4.864,00	PF	5.037,00
PX	5.097,00	PX	5.314,00	PX	5.487,00
PA	5.519,00	PA	5.735,00	PA	5.908,00

SAVILE ROW - Design Alessandro Dubini



I Divano cm. 163 con struttura in cuoietto cat CS o pelle cat. PS (**prezzo cat. CS**) o in cuoio cat CF, pelle cat. PF, PX (**prezzo cat. CF**) o in cuoio cat. CV, pelle cat. PA (**prezzo in cat. CV**). Cuscini in tessuto o pelle. Basamento in noce canaletto.
E Sofa cm. 163 with frame in saddle leather cat CS or leather cat. PS (**price in cat. CS**) or in saddle leather cat. CF or leather PF, PX (**price in cat. CF**) or saddle leather cat. CV or leather cat. PA (**price in cat. CV**). Cushions in fabric or leather. Base in black walnut wood.
F Canapé cm. 163 avec structure en cuir épais cat. CS ou cuir souple cat. PS (**prix en cat. CS**) ou en cuir épais cat. CF ou cuir souple cat. PF, PX ou PA (**prix en cat. CF**), ou en cuir épais cat. CV ou cuir souple cat. PA (**prix en cat. CV**). Coussins en tissu ou cuir souple. Piètement en noyer d’Amérique.
D Sofa cm. 163 mit Gestell in Rindleder cat. CS oder in Leder cat. PS (**preis in cat. CS**); in Rindleder CF oder in Leder cat. PF, PX (**preis in cat. CF**), in Rindleder CV oder in Leder cat. PA (**preis in cat. CV**). Kissen in Stoff oder in Leder. Fusse in Amerikanische Nussbaumholz.
S Sofá cm. 163 con estructura en cuero cat. CS o piel cat. PS (**precio en cat. CS**) o cuero en cat. CF o piel cat. PF, PX (**precio en cat. CF**), o cuero en cat. CV o piel cat. PA (**precio en cat. CV**). Cojines en tejido o tambien in piel. Base en nogal americano.

	SAVILECSDI163 Cat. CS	SAVILECFDI163 Cat. CF	SAVILECVDI163 Cat. CV
COM	4.740,00	5.043,00	5.285,00
L	4.842,00	5.145,00	5.387,00
T	4.964,00	5.266,00	5.509,00
S	5.066,00	5.368,00	5.610,00
Z	5.188,00	5.491,00	5.733,00
K	5.289,00	5.592,00	5.834,00
PS	5.639,00	5.942,00	6.184,00
PF	6.007,00	6.310,00	6.552,00
PX	6.595,00	6.898,00	7.140,00
PA	7.147,00	7.450,00	7.692,00

cm. 163 x 75 x h 74 – hs 39 • mt. 5.20
 in. 64”¹/₄ x 29”¹/₂ x h 29”¹/₂ – hs 15”³/₄ • yd. 5.70

SAVILE ROW - Design Alessandro Dubini



Tavolini. La struttura è in legno massello di noce canaletto con finitura “effetto cera”. Piano superiore e inferiore disponibili in cristallo extralight o in pannello nobilitato rivestito in cuoio o pelle.

Low tables. Frame in solid black walnut wood with “wax effect” finish. Upper and lower top available in extralight glass or in melamine coated panel covered in saddle leather or leather.



CR



CU



I Tavolino cm. 75x75 con piano in cristallo extralight (**CR**), in cuoio o pelle (**CU**). Base in noce canaletto
E Coffee table cm. 75x75 with top in extralight glass (**CR**), in saddle leather or in leather (**CU**). Base in black walnut wood.
F Table basse cm. 75x75 avec plan en verre extralight (**CR**) ou en cuir épais ou cuir souple (**CU**). Piètement en noyer d’Amérique.
D Tisch cm. 75x75 mit Platte in extralight Glas (**CR**), in Rindleder oder in Leder (**CU**). Fusse in Amerikanische Nussbaumholz.
S Mesa centro cm. 75x75 con tapa en cristal extralight (**CR**), en cuero o tambien in piel (**CU**). Base en nogal americano.



	SAVILETA075CR Cat. CR	SAVILETA075CU Cat. CU
CR	1.079,00	1.486,00
CV		1.391,00
CF		1.272,00
CS		1.452,00
PA		1.258,00
PX		1.305,00
PS		1.381,00

cm. 75 x 75 x h 37
 in. 29”¹/₂ x 29”¹/₂ x h 14”¹/₂

SAVILE ROW - Design Alessandro Dubini

 CR	 CU	<p>I Ripiano inferiore per tavolino cm. 75x75 in cristallo extralight (CR), in cuoio o pelle (CU). E Lower top for coffee table cm. 75x75 in extralight glass (CR), in saddle leather or in leather (CU). F Tablette inférieure pour table basse cm. 75x75 en verre extralight (CR) ou en cuir épais ou cuir souple (CU). D Untere Fachboden fuer Tisch cm. 75x75 in extralight Glas (CR), in Rindleder oder in Leder (CU). S Tapa inferior para mesa centro cm. 75x75 en cristal extralight (CR), en cuero o tambien in piel (CU).</p> <p>cm. 51.5 x 51.5 x h 1 in. 20³/₄ x 20³/₄ x h 3⁸/₁₆"</p>	SAVILERA052CR Cat. CR	SAVILERA052CU Cat. CU
			CR 158,00	CV 461,00 CF 412,00 CS 349,00 PA 444,00 PX 341,00 PF 367,00 PS 407,00

 CR	 CU	<p>I Tavolino cm. 150x75 con piano in cristallo extralight (CR), in cuoio o pelle (CU). Base in noce canaletto E Coffee table cm. 150x75 with top in extralight glass (CR), in saddle leather or in leather (CU). Base in black walnut wood. F Table basse cm. 150x75 avec plan en verre extralight (CR) ou en cuir épais ou cuir souple (CU). Pietement en noyer d'Amérique. D Tisch cm. 150x75 mit Platte in extralight Glas (CR), in Rindleder oder in Leder (CU). Fusse in Amerikanische Nussbaumholz. S Mesa centro cm. 150x75 con tapa en cristal extralight (CR), en cuero o tambien in piel (CU). Base en nogal americano.</p> <p>cm. 150 x 75 x h 37 in. 59" x 29¹/₂ x h 14¹/₂"</p>	SAVILETA152CR Cat. CR	SAVILETA152CU Cat. CU
			CR 1.454,00	CV 2.030,00 CF 1.866,00 CS 1.660,00 PA 1.972,00 PX 1.636,00 PF 1.718,00 PS 1.850,00

 CR	 CU	<p>I Ripiano inferiore per tavolino cm. 150x75 in cristallo extralight (CR), in cuoio o pelle (CU). E Lower top for coffee table cm. 150x75 in extralight glass (CR), in saddle leather or in leather (CU). F Tablette inférieure pour table basse cm. 150x75 en verre extralight (CR) ou en cuir épais ou cuir souple (CU). D Untere Fachboden fuer Tisch cm. 150x75 in extralight Glas (CR), in Rindleder oder in Leder (CU). S Tapa inferior para mesa centro cm. 150x75 en cristal extralight (CR), en cuero o tambien in piel (CU).</p> <p>cm. 126.5 x 51.5 x h 1 in. 49³/₄ x 20³/₄ x h 3⁸/₁₆"</p>	SAVILERA128CR Cat. CR	SAVILERA128CU Cat. CU
			CR 282,00	CV 716,00 CF 612,00 CS 482,00 PA 680,00 PX 467,00 PF 519,00 PS 602,00



Struttura. Il sedile è in legno massello di pioppo (stagionato "naturalmente" per almeno 3 anni) con elementi in multistrato di pioppo; giunzioni a incastro con spine cilindriche. Il molleggio è garantito da cinghie elastiche in polipropilene e lattice naturale. L'imbottitura del sedile è ottenuta con lastre di poliuretano espanso indeformabile a densità differenziate (35÷70 kg/m³) esente da CFC e rivestito con vellutino accoppiato. Lo schienale e i braccioli sono in pannello multistrato di pioppo e possono essere: a) impiallacciati in essenza tipo ebano; b) rivestiti con una lastra di poliuretano espanso e poi rivestiti in tessuto o pelle.

Cuscini. Cuscini di schienale e dei braccioli in poliuretano espanso indeformabile ed esente da CFC rivestito con ovatta poliestere.

Base. Struttura in tubolare d'acciaio verniciata a polveri epossidiche in colore RAL a scelta.

Rivestimento. Disponibile in tessuto e pelle; non sfoderabile.

Tavolino. Piano in pannello nobilitato rivestito in pelle. Base in tubolare d'acciaio verniciata a polveri epossidiche in colore RAL a scelta.

Frame. The seat frame is in solid poplar heartwood ("naturally" seasoned for at least 3 years) with connecting elements in poplar plywood; dap joints with cylindrical dowels. The webbing is secured by elastic polypropylene and natural latex belts. The framework is upholstered with contoured sheets of resilient, CFC-free polyurethane foam (with density of 35÷70 kg/m³) and covered by bonded plush. The backrest and the armrests are made in poplar plywood and can be: a) veneered with ebony type wood; b) covered with a sheet of polyurethane foam and then with fabric or leather.

Cushions. The backrest and armrests cushions are in resilient, CFC-free polyurethane foam covered with polyester wadding.

Base. Base in tubular steel epoxy powder painted in RAL colors of your choice.

Covers. Available in fabric or leather; non removable covers.

Low table. Top of melamine coated panel covered with leather. Base in tubular steel epoxy powder painted in RAL colors of your choice.

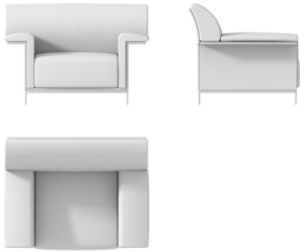

SHANGRPO123IM

I Poltrona.
E Armchair.
F Fauteuil.
D Sessel.
S Butaca.

cm. 130 x 100 x h 90 – hs 46 • mt. 7.95
in. 51¹/₄ x 39³/₄ x h 35¹/₂ – hs 18³/₄ • yd. 8.70

COM	2.882,00
L	3.022,00
T	3.229,00
S	3.401,00
Z	3.608,00
K	3.781,00
PS	4.518,00
PF	5.136,00
PX	6.125,00
PA	7.053,00

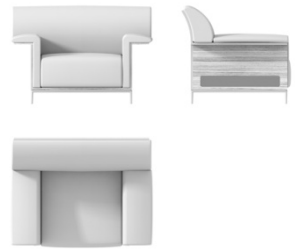

SHANGRPO123ES

I Poltrona con schienale e braccioli in essenza tipo ebano.
E Armchair with back and arms insimilar ebony wood.
F Fauteuil avec dossier et accoudoirs en placage comme ébène.
D Sessel mit Ruecken und Armlehnen in Ebenholz.
S Butaca con respaldo y brazos en ébano.

cm. 130 x 100 x h 90 – hs 46 • mt. 6.05
in. 51¹/₄ x 39³/₄ x h 35¹/₂ – hs 18³/₄ • yd. 6.60

COM	4.895,00
L	5.022,00
T	5.174,00
S	5.301,00
Z	5.454,00
K	5.581,00
PS	6.103,00
PF	6.560,00
PX	7.224,00
PA	7.931,00

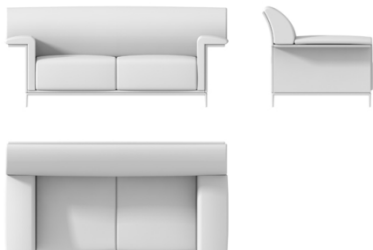

SHANGRDI193IM

I Divano 2 posti cm. 193.
E 2 seater sofa cm. 193.
F Canapé 2 places cm. 193.
D Sofa 2-sitzig cm. 193.
S Sofá de 2 plazas cm. 193.

cm. 200 x 100 x h 90 – hs 46 • mt. 12.20
in. 78³/₄ x 39³/₄ x h 35¹/₂ – hs 18³/₄ • yd. 13.35

COM	3.825,00
L	4.090,00
T	4.407,00
S	4.671,00
Z	4.988,00
K	5.252,00
PS	6.489,00
PF	7.441,00
PX	8.963,00
PA	10.391,00

	<p>SHANGRDI193ES</p> <p>I Divano 2 posti cm. 193 con schienale e braccioli in essenza tipo ebano. E 2 seater sofa cm. 193 with back and arms in ebony wood. F Canapé 2 places cm. 193 avec dossier et accoudoirs en placage comme ébène. D Sofa 2-sitzig cm. 193 mit Ruecken und Armlehnen in Ebenholz. S Sofá de 2 plazas cm. 193 con respaldo y brazos en ébano.</p>	<p>COM 5.072,00 L 5.233,00 T 5.428,00 S 5.590,00 Z 5.783,00 K 5.945,00 PS 6.700,00 PF 7.281,00 PX 8.210,00 PA 9.080,00</p>
	<p>SHANGRDI233IM</p> <p>I Divano 2 posti cm. 233. E 2 seater sofa cm. 233. F Canapé 2 places cm. 233. D Sofa 2-sitzig cm. 233. S Sofá de 2 plazas cm. 233.</p>	<p>COM 4.315,00 L 4.584,00 T 4.906,00 S 5.176,00 Z 5.498,00 K 5.767,00 PS 7.009,00 PF 7.971,00 PX 9.509,00 PA 10.951,00</p>
	<p>SHANGRDI233ES</p> <p>I Divano 2 posti cm. 233 con schienale e braccioli in essenza tipo ebano. E 2 seater sofa cm. 233 with back and arms in ebony wood. F Canapé 2 places cm. 233 avec dossier et accoudoirs en placage comme ébène. D Sofa 2-sitzig cm. 233 mit Ruecken und Armlehnen in Ebenholz. S Sofá de 2 plazas cm. 233 con respaldo y brazos en ébano.</p>	<p>COM 7.591,00 L 7.753,00 T 7.946,00 S 8.774,00 Z 8.968,00 K 8.465,00 PS 9.249,00 PF 9.835,00 PX 10.772,00 PA 11.649,00</p>
	<p>SHANGRDI263IM</p> <p>I Divano 3 posti cm. 263. E 3 seater sofa cm. 263. F Canapé 3 places cm. 263. D Sofa 3-sitzig cm. 263. S Sofá de 3 plazas cm.263.</p>	<p>COM 4.857,00 L 5.143,00 T 5.485,00 S 5.771,00 Z 6.113,00 K 6.399,00 PS 7.745,00 PF 8.770,00 PX 10.411,00 PA 11.949,00</p>
	<p>SHANGRDI263ES</p> <p>I Divano 3 posti cm. 263 con schienale e braccioli in essenza tipo ebano. E 3 seater sofa cm. 263 with back and arms in ebony wood. F Canapé 3 places cm. 263 avec dossier et accoudoirs en placage comme ébène. D Sofa 3-sitzig cm. 263 mit Ruecken und Armlehnen in Ebenholz. S Sofá de 3 plazas cm. 263 con respaldo y brazos en ébano.</p>	<p>COM 6.083,00 L 6.261,00 T 6.476,00 S 6.654,00 Z 6.868,00 K 7.799,00 PS 7.805,00 PF 8.424,00 PX 9.414,00 PA 10.342,00</p>
	<p>SHANGRTA180IM</p> <p>I Tavolino rivestito in pelle. E Coffee table covered in leather. F Table basse recouvert en cuir souple. D Tisch in Leder bezogen. S Mesa centro en piel.</p>	<p>PS 1.166,00 PF 1.291,00 PX 1.488,00 PA 1.674,00</p>

cm. 200 x 100 x h 90 – hs 46 • mt. 7.50
 in. 78”½ x 39”¾ x h 35”½ – hs 18”¾ • yd. 8.20

cm. 240 x 100 x h 90 – hs 46 • mt. 12.45
 in. 94”½ x 39”¾ x h 35”½ – hs 18”¾ • yd. 13.60

cm. 240 x 100 x h 90 – hs 46 • mt. 7.50
 in. 94”½ x 39”¾ x h 35”½ – hs 18”¾ • yd. 8.20

cm. 270 x 100 x h 90 – hs 46 • mt. 13.20
 in. 106”¼ x 39”¾ x h 35”½ – hs 18”¾ • yd. 13.75

cm. 270 x 100 x h 90 – hs 46 • mt. 8.25
 in. 106”¼ x 39”¾ x h 35”½ – hs 18”¾ • yd. 9.05

cm. 180 x 100 x h 15
 in. 70”¾ x 39”¾ x h 5”¾

SINGLE - Design Ammannati & Vitelli



Struttura. In tubolare d'acciaio. Il molleggio è garantito da cinghie elastiche in polipropilene e lattice naturale fissate alla struttura in acciaio. L'imbottitura è ottenuta con lastre di poliuretano espanso indeformabile a densità differenziate esente da CFC e rivestito con ovatta poliesteri; l'imbottitura è cucita direttamente assieme al rivestimento in tessuto o pelle.

La poltrona è disponibile in versione girevole o reclinabile. Nella versione reclinabile la struttura è dotata di meccanismo di movimento sincronizzato di sedile e poggia gambe mosso da motore elettrico (disponibile a 220V o 110V) con telecomando a filo.

Cuscini. Cuscino di seduta in poliuretano espanso rivestito con ovatta poliesteri e fissato alla struttura tramite cerniera.

Base. Base in tubolare d'acciaio disponibile solo cromata.

Rivestimento. Disponibile in tessuto e pelle; non sfoderabile.

Tavolino. Piano in pannello MDF rivestito in cuoio. Tasca portaoggetti in pelle. Base in tubolare d'acciaio cromata con estremità in legno massello di bubinga e ruote in legno.

Frame. In tubular steel. The webbing is secured by elastic polypropylene and natural latex belts fixed to the metal frame. The framework is upholstered with contoured sheets of resilient, CFC-free polyurethane foam with different density and covered by polyester wadding; the upholstery is sewed directly to the cover in fabric or leather.

The armchair is available on swivel or reclining. In the recline version the frame is equipped with a mechanism that allows a synchronized movement of backrest and footrest through an electric motor (220V or 110V) with a wired remote control.

Cushions. Seat cushion in polyurethane foam covered by polyester wadding and fixed to the frame through a zip.

Base. Base in tubular steel available chromed.

Covers. Available in fabric or leather; non removable covers.

Low table. Top in MDF covered in saddle leather; handy magazine rack in leather. Base in tubular chromed steel with details in solid bubinga wood and wheels in wood.



SINGLEPOLTREM

I Poltrona relax con motore elettrico.
E Relax armchair with electric engine.
F Fauteuil relax avec moteur électrique.
D Relax Sessel mit elektrischen Motor.
S Sillón relax con motor eléctrico.

cm. 108 x 98/163 x h 118/86 – hs 45 • mt. 6.45
in. 42¹/₂ x 38¹/₂/64¹/₄ x h 46¹/₂/33¹/₄ – hs 17¹/₄ • yd. 7.05

COM	3.131,00
L	3.258,00
T	3.410,00
S	3.537,00
Z	3.689,00
K	3.816,00
PS	4.393,00
PF	4.890,00
PX	5.687,00
PA	6.433,00



SINGLEPOLTGIR

I Poltrona girevole.
E Swivel armchair.
F Fauteuil tournant.
D Drehsessel.
S Sillón giratorio.

cm. 108 x 105 x h 118 – hs 46 • mt. 6.45
in. 42¹/₂ x 41¹/₄ x h 46¹/₂ – hs 18¹/₄ • yd. 7.05

COM	2.804,00
L	2.926,00
T	3.072,00
S	3.194,00
Z	3.340,00
K	3.462,00
PS	3.808,00
PF	4.221,00
PX	5.127,00
PA	5.810,00

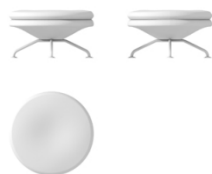

SINGLEPOUF000

I Pouf.
E Ottoman.
F Pouf.
D Hocker.
S Pouf.

cm. 76 x 76 x h 41 – hs 18 • mt. 2.50
in. 29¹/₄ x 29¹/₄ x h 16¹/₄ – hs 7¹/₄ • yd. 2.75

COM	767,00
L	823,00
T	888,00
S	942,00
Z	1.008,00
K	1.063,00
PS	1.056,00
PF	1.190,00
PX	1.491,00
PA	1.715,00

SINGLE - Design Ammannati & Vitelli



SINGLETAVOLIN

I Tavolino.

E Coffee table.

F Petite table.

D Couchtisch.

S Mesa auxiliar.

CV 811,00

CF 771,00

CS 722,00

cm. 40 x 69 x h 64

in. 15³/₄ x 27¹/₄ x h 25³/₄

TUDOR - Design Alessandro Dubini



Struttura. In legno massello di pioppo (stagionato "naturalmente" per almeno 3 anni) con elementi in pannelli multistrato di pioppo; giunzioni a incastro con spine cilindriche. Il molleggio è garantito da cinghie elastiche in polipropilene e lattice naturale. L'imbottitura della struttura è ottenuta con lastre di poliuretano espanso indeformabile con densità di 30 kg/m³ esente da CFC.

Cuscini. Cuscini di seduta in poliuretano espanso a densità differenziate con densità di 35 kg/m³ ed esente da CFC.

Base. Piedini PVC nero

Rivestimento. Disponibile in tessuto e pelle con tipica lavorazione a mano capitonné; non sfoderabile.

Frame. In solid poplar heartwood ("naturally" seasoned for at least 3 years) with connecting elements in poplar plywood; dap joints with cylindrical dowels. The webbing is secured by elastic polypropylene and natural latex belts. The framework is upholstered with contoured sheets of resilient, CFC-free polyurethane foam with density of 30 kg/m³.

Cushions. The seat cushions are in CFC-free polyurethane foam with density of 35 kg/m³.

Base. Supports in black PVC.

Covers. Available in fabric or leather with the characteristic hand-made capitonné work; non removable covers.



TUDOR0POLT126

I Poltrona.
E Armchair.
F Fauteuil.
D Sessel.
S Butaca.

cm. 126 x 97 x h 70 – hs 43 • mt. 8.80
in. 49³/₈" x 38³/₈" x h 27¹/₂" – hs 16³/₈" • yd. 9.65

COM	4.576,00
L	4.749,00
T	4.957,00
S	5.130,00
Z	5.338,00
K	5.512,00
PS	6.948,00
PF	7.814,00
PX	9.198,00
PA	10.496,00



TUDOR0DIVA198

I Divano 2 posti.
E 2 seater sofa.
F Canapé 2 places.
D Sofa 2-sitzig.
S Sofá de 2 plazas.

cm. 198 x 97 x h 70 – hs 43 • mt. 12.65
in. 78³/₈" x 38³/₈" x h 27¹/₂" – hs 16³/₈" • yd. 13.85

COM	5.392,00
L	5.641,00
T	5.940,00
S	6.188,00
Z	6.487,00
K	6.735,00
PS	7.567,00
PF	8.433,00
PX	9.817,00
PA	11.115,00



TUDOR0DIVA222

I Divano 3 posti cm. 222.
E 3 seater sofa cm. 222.
F Canapé 3 places cm. 222.
D Sofa 3-sitzig cm. 222.
S Sofá de 3 plazas cm. 222.

cm. 222 x 97 x h 70 – hs 43 • mt. 15.00
in. 87³/₈" x 38³/₈" x h 27¹/₂" – hs 16³/₈" • yd. 16.40

COM	5.966,00
L	6.275,00
T	6.646,00
S	6.955,00
Z	7.325,00
K	7.634,00
PS	8.858,00
PF	9.994,00
PX	11.811,00
PA	13.515,00



TUDOR0DIVA246

I Divano 3 posti cm. 246.
E 3 seater sofa cm. 246.
F Canapé 3 places cm. 246.
D Sofa 3-sitzig cm. 246.
S Sofá de 3 plazas cm. 246.

cm. 246 x 97 x h 70 – hs 43 • mt. 15.40
in. 96³/₈" x 38³/₈" x h 27¹/₂" – hs 16³/₈" • yd. 16.85

COM	6.363,00
L	6.681,00
T	7.063,00
S	7.380,00
Z	7.762,00
K	8.080,00
PS	9.232,00
PF	10.367,00
PX	12.184,00
PA	13.887,00

TUDOR - Design Alessandro Dubini

	<p>TUDORODIVA270</p> <p>I Divano 4 posti. E 4 seater sofa. F Canapé 4 places. D Sofa 4-sitzig. S Sofá de 4 plazas.</p>	<p>COM 6.592,00 L 6.922,00 T 7.316,00 S 7.646,00 Z 8.041,00 K 8.371,00 PS 9.431,00 PF 10.567,00 PX 12.384,00 PA 14.087,00</p>
<p>cm. 270 x 97 x h 70 – hs 43 • mt. 16.00 in. 106³/₄ x 38³/₄ x h 27³/₄ – hs 16³/₄ • yd. 17.50</p>		
	<p>TUDOROISOLADX</p> <p>I Chaiselongue angolare destra. E Angular right chaiselongue. F Dormeuse angulaire droite. D Rechte winklige Dormeuse. S Chaise longue angular derecha.</p>	<p>COM 5.941,00 L 6.271,00 T 6.666,00 S 6.996,00 Z 7.390,00 K 7.720,00 PS 8.799,00 PF 9.934,00 PX 11.751,00 PA 13.455,00</p>
<p>cm. 260 x 136 x h 70 – hs 43 • mt. 16.00 in. 102³/₄ x 53³/₄ x h 27³/₄ – hs 16³/₄ • yd. 17.50</p>		
	<p>TUDOROISOLASX</p> <p>I Chaiselongue angolare sinistra. E Angular left chaiselongue. F Dormeuse angulaire gauche. D Linke winklige Dormeuse. S Chaise longue angular izquierda.</p>	<p>COM 5.941,00 L 6.271,00 T 6.666,00 S 6.996,00 Z 7.390,00 K 7.720,00 PS 8.799,00 PF 9.934,00 PX 11.751,00 PA 13.455,00</p>
<p>cm. 260 x 136 x h 70 – hs 43 • mt. 16.00 in. 102³/₄ x 53³/₄ x h 27³/₄ – hs 16³/₄ • yd. 17.50</p>		
	<p>TUDOROPOUFQUA</p> <p>I Pouf cm. 122x122. E Ottoman cm. 122x122. F Pouf cm 122x122. D Hocker cm. 122x122. S Pouf cm. 122x122.</p>	<p>COM 4.373,00 L 4.495,00 T 4.640,00 S 4.762,00 Z 4.907,00 K 5.027,00 PS 5.443,00 PF 5.875,00 PX 6.567,00 PA 7.216,00</p>
<p>cm. 122 x 122 x h 43 – hs 43 • mt. 6.20 in. 48" x 48" x h 16³/₄ – hs 16³/₄ • yd. 6.80</p>		
	<p>TUDOROPOUFRET</p> <p>I Pouf cm. 146x74. E Ottoman cm. 146x74. F Pouf cm 146x74. D Hocker cm. 146x74. S Pouf cm. 146x74.</p>	<p>COM 4.319,00 L 4.449,00 T 4.605,00 S 4.735,00 Z 4.890,00 K 5.020,00 PS 5.366,00 PF 5.799,00 PX 6.491,00 PA 7.140,00</p>
<p>cm. 146 x 74 x h 43 – hs 43 • mt. 6.60 in. 57³/₄ x 29³/₄ x h 16³/₄ – hs 16³/₄ • yd. 7.20</p>		

TWIBE - Design Daniele Lo Scalzo Moscheri



Poltrona. Lo schienale e la seduta hanno una struttura in tubolare d'acciaio; il molleggio è garantito da cinghie elastiche in polipropilene e lattice naturale fissate alla struttura della seduta. Le due strutture separate di schienale e sedile sono annegate in poliuretano espanso, schiumato a freddo in due opportuni stampi e rivestite con fibre di poliestere. La schiuma poliuretanicca soddisfa la classe 1 IM di resistenza al fuoco secondo la legge italiana ed è disponibile anche secondo altri standard internazionali. Il basamento è in acciaio e girevole.

Struttura. In legno massello di pioppo (stagionato "naturalmente" per almeno 3 anni) con elementi in multistrato di pioppo curvato in stampo per il bracciolo; giunzioni a incastro con spine cilindriche. Il molleggio è garantito da cinghie elastiche in polipropilene e lattice naturale. L'imbottitura della struttura è ottenuta con lastre di poliuretano espanso indeformabile a densità differenziate esente da CFC e ricoperto da ovatta poliestere e vellutino accoppiato. Per motivi estetici sul bracciolo è fissato un tubolare d'acciaio disponibile cromato o verniciato a polveri epossidiche in colore RAL a scelta.

Cuscini. Cuscini di schienale in piuma canalizzata.

Base. In tubolare d'acciaio disponibile cromata o verniciata a polveri epossidiche in colore RAL a scelta.

Rivestimento. Disponibile in tessuto e pelle; non sfoderabile.

Armchair. The frames of the backrest and of the seat are in tubular steel; the webbing is secured by elastic polypropylene and natural latex belts fixed to the metal frame of the seat. The two frames are embedded in cold formed polyurethane foam made in two different moulds and covered by polyester wadding. The foam complies with the Italian Classe 1IM fire resistant law and is available on request for other international standards. Metal swivel base.

Frame. In solid poplar heartwood ("naturally" seasoned for at least 3 years) with connecting elements in poplar plywood for the arms; dap joints with cylindrical dowels. The webbing is secured by elastic polypropylene and natural latex belts. The framework is upholstered with contoured sheets of resilient, CFC-free polyurethane foam with different density and covered by polyester wadding and bonded plush. For aesthetic reasons, on the arm is fixed a tubular steel available chromed or epoxy powder painted in RAL colors of your choice.

Cushions. The back cushions are feather-filled.

Base. In tubular steel available chromed or epoxy powder painted in RAL colors of your choice.

Covers. Available in fabric or leather; non removable covers.

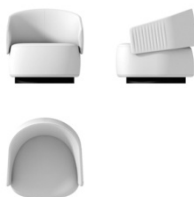

TWIBE0POLTGIR

I Poltroncina con base girevole.
E Small armchair with swivel base.
F Petit fauteuil tournant.
D Drehsessel.
S Sillón giratorio.

cm. 71 x 80 x h 73 – hs 35 • mt. 3.30
in. 28" x 31"½ x h 28"¾ – hs 13"¾ • yd. 3.60

COM	2.524,00
L	2.587,00
T	2.663,00
S	2.726,00
Z	2.801,00
K	2.864,00
PS	3.081,00
PF	3.303,00
PX	3.659,00
PA	3.993,00



TWIBE0POLT116

I Poltrona cm 116 con basamento in acciaio cromato nero o verniciato in colore RAL.
E Armchair cm. 116 with base in steel black chromed or varnished in RAL colour.
F Fauteuil cm. 116 avec avec piètement en acier chromé noir ou verni en couleur RAL.
D Sessel cm. 116 mit Stahl schwarz verchromtem Fuss oder in RAL-Farbe lackiert.
S Butaca cm. 116 con base en acero cromado negro o pintado en color RAL.

cm. 116 x 100 x h 85 – hs 40 • mt. 6.70
in. 45"¾ x 39"¾ x h 33"½ – hs 15"¾ • yd. 7.35

COM	3.425,00
L	3.557,00
T	3.714,00
S	3.847,00
Z	4.005,00
K	4.136,00
PS	4.631,00
PF	5.107,00
PX	5.869,00
PA	6.583,00









TWIBE0POLT126

I Poltrona cm 126 con basamento in acciaio cromato nero o verniciato in colore RAL.
E Armchair cm. 126 with base in steel black chromed or varnished in RAL colour.
F Fauteuil cm. 126 avec avec piètement en acier chromé noir ou verni en couleur RAL.
D Sessel cm. 126 mit Stahl schwarz verchromtem Fuss oder in RAL-Farbe lackiert.
S Butaca cm. 126 con base en acero cromado negro o pintado en color RAL.

cm. 126 x 100 x h 85 – hs 40 • mt. 7.00
in. 49"¾ x 39"¾ x h 33"½ – hs 15"¾ • yd. 7.65

COM	3.460,00
L	3.592,00
T	3.749,00
S	3.882,00
Z	4.040,00
K	4.172,00
PS	4.666,00
PF	5.142,00
PX	5.904,00
PA	6.618,00

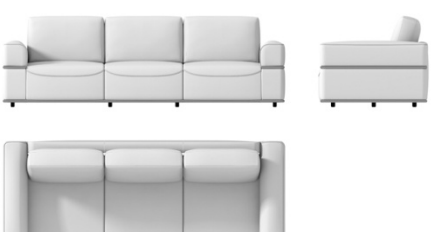
TWIBE - Design Daniele Lo Scalzo Moscheri

	<p>TWIBE0POLT141</p> <p>I Poltrona cm 141 con basamento in acciaio cromato nero o verniciato in colore RAL. E Armchair cm. 141 with base in steel black chromed or varnished in RAL colour. F Fauteuil cm. 141 avec avec piètement en acier chromé noir ou verni en couleur RAL. D Sessel cm. 141 mit Stahl schwarz verchromtem Fuss oder in RAL-Farbe lackiert. S Butaca cm. 141 con base en acero cromado negro o pintado en color RAL.</p>	<p>COM 3.412,00 L 3.558,00 T 3.732,00 S 3.876,00 Z 4.050,00 K 4.195,00 PS 4.725,00 PF 5.244,00 PX 6.074,00 PA 6.853,00</p>
	<p>TWIBE0DIVA186</p> <p>I Divano 2 posti cm. 186 con basamento in acciaio cromato nero o verniciato in colore RAL. E 2 seater sofa cm. 186 with base in steel black chromed or varnished in RAL colour. F Canapé 2 places cm. 186 avec avec piètement en acier chromé noir ou verni en couleur RAL. D Sofa 2-sitzig cm. 186 mit Stahl schwarz verchromtem Fuss oder in RAL-Farbe lackiert. S Sofà de 2 plazas cm. 186 con base en acero cromado negro o pintado en color RAL.</p>	<p>COM 4.403,00 L 4.596,00 T 4.828,00 S 5.019,00 Z 5.251,00 K 5.444,00 PS 6.159,00 PF 6.852,00 PX 7.959,00 PA 8.997,00</p>
	<p>TWIBE0DIVA206</p> <p>I Divano 2 posti cm. 206 con basamento in acciaio cromato nero o verniciato in colore RAL. E 2 seater sofa cm. 206 with base in steel black chromed or varnished in RAL colour. F Canapé 2 places cm. 206 avec avec piètement en acier chromé noir ou verni en couleur RAL. D Sofa 2-sitzig cm. 206 mit Stahl schwarz verchromtem Fuss oder in RAL-Farbe lackiert. S Sofà de 2 plazas cm. 206 con base en acero cromado negro o pintado en color RAL.</p>	<p>COM 4.889,00 L 5.094,00 T 5.342,00 S 5.547,00 Z 5.794,00 K 5.999,00 PS 6.750,00 PF 7.485,00 PX 8.662,00 PA 9.765,00</p>
	<p>TWIBE0DIVA236</p> <p>I Divano 2 posti cm. 236 con basamento in acciaio cromato nero o verniciato in colore RAL. E 2 seater sofa cm. 236 with base in steel black chromed or varnished in RAL colour. F Canapé 2 places cm. 236 avec avec piètement en acier chromé noir ou verni en couleur RAL. D Sofa 2-sitzig cm. 236 mit Stahl schwarz verchromtem Fuss oder in RAL-Farbe lackiert. S Sofà de 2 plazas cm. 236 con base en acero cromado negro o pintado en color RAL.</p>	<p>COM 4.726,00 L 4.942,00 T 5.202,00 S 5.418,00 Z 5.677,00 K 5.894,00 PS 6.697,00 PF 7.476,00 PX 8.721,00 PA 9.889,00</p>
	<p>TWIBE0DIVA256</p> <p>I Divano 3 posti cm. 256 con basamento in acciaio cromato nero o verniciato in colore RAL. E 3 seater sofa cm. 256 with base in steel black chromed or varnished in RAL colour. F Canapé 3 places cm. 256 avec avec piètement en acier chromé noir ou verni en couleur RAL. D Sofa 3-sitzig cm. 256 mit Stahl schwarz verchromtem Fuss oder in RAL-Farbe lackiert. S Sofà de 3 plazas cm. 256 con base en acero cromado negro o pintado en color RAL.</p>	<p>COM 5.576,00 L 5.826,00 T 6.124,00 S 6.373,00 Z 6.671,00 K 6.920,00 PS 7.877,00 PF 8.786,00 PX 10.239,00 PA 11.602,00</p>
	<p>TWIBE0DIVA286</p> <p>I Divano 3 posti cm. 286 con basamento in acciaio cromato nero o verniciato in colore RAL. E 3 seater sofa cm. 286 with base in steel black chromed or varnished in RAL colour. F Canapé 3 places cm. 286 avec avec piètement en acier chromé noir ou verni en couleur RAL. D Sofa 3-sitzig cm. 286 mit Stahl schwarz verchromtem Fuss oder in RAL-Farbe lackiert. S Sofà de 3 plazas cm. 286 con base en acero cromado negro o pintado en color RAL.</p>	<p>COM 5.581,00 L 5.840,00 T 6.152,00 S 6.412,00 Z 6.723,00 K 6.982,00 PS 7.992,00 PF 8.943,00 PX 10.466,00 PA 11.893,00</p>

TWIBE - Design Daniele Lo Scalzo Moscheri

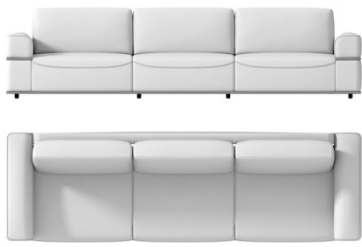

TWIBE0DIVA331

I Divano 3 posti cm. 331 con basamento in acciaio cromato nero o verniciato in colore RAL.
 E 3 seater sofa cm. 331 with base in steel black chromed or varnished in RAL colour.
 F Canapé 3 places cm. 331 avec avec piètement en acier chromé noir ou verni en couleur RAL.
 D Sofa 3-sitzig cm. 331 mit Stahl schwarz verchromtem Fuss oder in RAL-Farbe lackiert.
 S Sofà de 3 plazas cm. 331 con base en acero cromado negro o pintado en color RAL.

cm. 331 x 100 x h 85 – hs 40 • mt. 13.80
 in. 130³/₈ x 39³/₈ x h 33³/₈ – hs 15³/₈ • yd. 15.10

COM	5.833,00
L	6.103,00
T	6.427,00
S	6.698,00
Z	7.023,00
K	7.292,00
PS	8.353,00
PF	9.348,00
PX	10.941,00
PA	12.433,00



TWIBE0ISOL168

I Elemento di seduta cm. 168x168 con basamento in acciaio cromato nero o verniciato in colore RAL.
 E Seating element cm. 168x168 with base in steel black chromed or varnished in RAL colour.
 F Élément d'assise cm. 168x168 avec avec piètement en acier chromé noir ou verni en couleur RAL.
 D Sizing Element cm. 168x168 mit Stahl schwarz verchromtem Fuss oder in RAL-Farbe lackiert.
 S Elemento de asiento cm. 168x168 con base en acero cromado negro o pintado en color RAL.

cm. 173 x 173 x h 85 – hs 40 • mt. 10.00
 in. 68³/₈ x 68³/₈ x h 33³/₈ – hs 15³/₈ • yd. 10.95

COM	4.666,00
L	4.861,00
T	5.094,00
S	5.289,00
Z	5.522,00
K	5.717,00
PS	6.291,00
PF	6.944,00
PX	7.990,00
PA	8.970,00

TWIBE - Design Daniele Lo Scalzo Moscheri



Tavolino. Piano disponibile in marmo o in pannello nobilitato rivestito in pelle o cuoio. Base in tubolare d'acciaio cromata o verniciata a polveri epossidiche in colore RAL a scelta.

Low table. Top available in marble or in melamine coated panel covered with leather or saddle leather. Base in tubular steel chromed or epoxy powder painted in RAL colors of your choice.

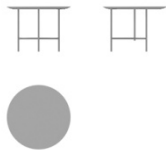

TWIBE0TA060CU

I Tavolino Ø cm. 60 con piano in cuoio. Basamento in acciaio cromato nero o verniciato in colore RAL.
 E Coffee table Ø cm. 60 with top in saddle leather. Base in steel black chromed or varnished RAL color.
 F Table basse Ø cm. 60 avec plan en cuir épais. Piètement en acier chromé noir ou verni en couleur RAL.
 D Tisch Ø cm. 60 mit Platte in Rindleder. Stahl schwarz verchromtem Fuss oder in RAL-Farbe lackiert.
 S Mesa centro Ø cm. 60 con tapa de cuero. Base en acero cromado negro o pintado en color RAL.

cm. 60 x 60 x h 42
 in. 23³/₈ x 23³/₈ x h 16³/₈

CV	1.652,00
CF	1.574,00
CS	1.477,00



TWIBE0TA060MC

I Tavolino Ø cm. 60 con piano in marmo Calacatta oro. Basamento in acciaio cromato nero o verniciato in colore RAL.
 E Coffee table Ø cm. 60 with top in Calacatta Oro marble. Base in steel black chromed or varnished RAL color.
 F Table basse Ø cm. 60 avec plan en marbre Calacatta oro. Piètement en acier chromé noir ou verni en couleur RAL.
 D Tisch Ø cm. 60 mit Platte in Calacatta Oro Marmor. Stahl schwarz verchromtem Fuss oder in RAL-Farbe lackiert.
 S Mesa centro Ø cm. 60 con tapa de mármol Calacatta Oro. Base en acero cromado negro o pintado en color RAL.

cm. 60 x 60 x h 42
 in. 23³/₈ x 23³/₈ x h 16³/₈

1.887,00

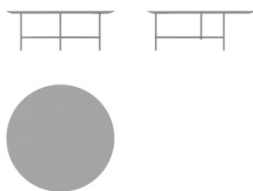

TWIBE0TA100CU

I Tavolino Ø cm. 100 con piano in cuoio. Basamento in acciaio cromato nero o verniciato in colore RAL.
 E Coffee table Ø cm. 100 with top in saddle leather. Base in steel black chromed or varnished RAL color.
 F Table basse Ø cm. 100 avec plan en cuir épais. Piètement en acier chromé noir ou verni en couleur RAL.
 D Tisch Ø cm. 100 mit Platte in Rindleder. Stahl schwarz verchromtem Fuss oder in RAL-Farbe lackiert.
 S Mesa centro Ø cm. 100 con tapa de cuero. Base en acero cromado negro o pintado en color RAL.

CV 2.347,00
 CF 2.174,00
 CS 1.958,00

cm. 100 x 100 x h 37
 in. 39³/₈ x 39³/₈ x h 14¹/₂



TWIBE0TA100MC

I Tavolino Ø cm. 100 con piano in marmo Calacatta oro. Basamento in acciaio cromato nero o verniciato in colore RAL.
 E Coffee table Ø cm. 100 with top in Calacatta Oro marble. Base in steel black chromed or varnished RAL color.
 F Table basse Ø cm. 100 avec plan en marbre Calacatta oro. Piètement en acier chromé noir ou verni en couleur RAL.
 D Tisch Ø cm. 100 mit Platte in Calacatta Oro Marmor. Stahl schwarz verchromtem Fuss oder in RAL-Farbe lackiert.
 S Mesa centro Ø cm. 100 con tapa de mármol Calacatta Oro. Base en acero cromado negro o pintado en color RAL.

3.297,00

cm. 100 x 100 x h 37
 in. 39³/₈ x 39³/₈ x h 14¹/₂



TWIBE0TA040CU

I Tavolino Ø cm. 40 con piano in cuoio da applicare come elemento satellite al tavolino Ø cm. 100. Basamento in acciaio cromato nero o verniciato in colore RAL.
 E Coffee table Ø cm. 40 with top in saddle leather to be fixed as a satellite element to the Ø cm coffee table. 100. Base in steel black chromed or varnished RAL color.
 F Table basse Ø cm. 40 avec plan en cuir épais à fixer comme élément satellite à la table basse Ø cm. 100. Piètement en acier chromé noir ou verni en couleur RAL.
 D Tisch Ø cm. 40 mit Platte in Rindleder als Satellitenelement am Couchtisch Ø cm 100 befestigt werden.. Stahl schwarz verchromtem Fuss oder in RAL-Farbe lackiert.
 S Mesa centro Ø cm. 40 con tapa de cuero para ser fijado como elemento satélite a la mesa de centro Ø cm. 100. Base en acero cromado negro o pintado en color RAL.

CV 1.464,00
 CF 1.420,00
 CS 1.367,00

cm. 40/73 x 40 x h 42
 in. 15³/₈/28³/₈ x 15³/₈ x h 16¹/₂



TWIBE0TA040MC

I Tavolino Ø cm. 40 con piano in marmo Calacatta oro da applicare come elemento satellite al tavolino Ø cm. 100.. Basamento in acciaio cromato nero o verniciato in colore RAL.
 E Coffee table Ø cm. 40 with top in Calacatta Oro marble to be fixed as satellite element to the coffee table Ø cm. 100. Base in steel black chromed or varnished RAL color.
 F Table basse Ø cm. 40 avec plan en marbre Calacatta oro à fixer comme élément satellite à la table basse Ø cm. 100. Piètement en acier chromé noir ou verni en couleur RAL.
 D Tisch Ø cm. 40 mit Platte in Calacatta Oro Marmor als Satellitenelement am Couchtisch Ø cm 100 befestigt werden. Stahl schwarz verchromtem Fuss oder in RAL-Farbe lackiert.
 S Mesa centro Ø cm. 40 con tapa de mármol Calacatta Oro para ser fijado como elemento satélite a la mesa de centro Ø cm. 100. Base en acero cromado negro o pintado en color RAL.

1.458,00

cm. 40/73 x 40 x h 42
 in. 15³/₈/28³/₈ x 15³/₈ x h 16¹/₂

UP & DOWN - Design Ammannati & Vitelli



Struttura. In tubolare d'acciaio. Il molleggio è garantito da cinghie elastiche in polipropilene e lattice naturale fissate alla struttura in acciaio. L'imbottitura è ottenuta con lastre di poliuretano espanso indeformabile a densità differenziate esente da CFC e rivestito con ovatta poliesteri; l'imbottitura è cucita direttamente assieme al rivestimento in tessuto o pelle.

La struttura è dotata di meccanismo di movimento sincronizzato di sedile e poggia gambe mosso da motore elettrico (disponibile a 220V o 110V) con telecomando a filo.

Cuscini. Cuscino poggiatesta in poliuretano espanso rivestito con ovatta poliesteri.

Base. Base in tubolare d'acciaio disponibile solo cromata.

Rivestimento. Disponibile in tessuto e pelle; non sfoderabile.

Frame. In tubular steel. The webbing is secured by elastic polypropylene and natural latex belts fixed to the metal frame. The framework is upholstered with contoured sheets of resilient, CFC-free polyurethane foam and covered by polyester wadding; the upholstery is sewed directly to the cover in fabric or leather. The frame is equipped with a mechanism that allows a synchronized movement of backrest and footrest through an electric motor (220V or 110V) with a wired remote control.

Cushions. Headrest cushion in polyurethane foam covered by polyester wadding.

Base. Base in tubular steel available chromed.

Covers. Available in fabric or leather; non removable covers.

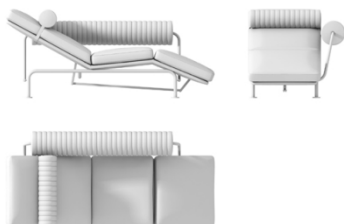

UPDOWNDIVANET

I Divanetto trasformabile in chaise longue tramite motore elettrico.

E Sofa that can be changed into chaiselongue by an electric motor.

F Canapé qui peut se transformer en chaise longue grâce à un moteur électrique.

D Verwandelbaren Sofa in einem Chaise-longue durch elektrischen Motor.

S Sofá convertible en chaiselongue por medio de motor eléctrico.

cm. 160/199 x 96 x h 73/104 – hs 44 • mt. 6.25
in. 63"/78" x 37" x h 28"/41" – hs 17" • yd. 6.85

COM	4.191,00
L	4.327,00
T	4.490,00
S	4.625,00
Z	4.787,00
K	4.923,00
PS	5.334,00
PF	5.801,00
PX	6.820,00
PA	7.591,00



UPDOWNRULLOOO

I Cuscino a rullo.

E Bolster cushion.

F Boudin.

D Rolle Kissen.

S Rullo.

cm. 60 x 20 x h 20 • mt. 0.60
in. 23" x 7" x h 7" • yd. 0.65

COM	161,00
L	169,00
T	180,00
S	188,00
Z	200,00
K	209,00
PS	224,00
PF	250,00
PX	306,00
PA	350,00

WOODY - Design Umberto Anago



Struttura. In legno massello di pioppo (stagionato "naturalmente" per almeno 3 anni); giunzioni a incastro con spine cilindriche. Il molleggio è garantito da cinghie elastiche in polipropilene e lattice naturale. L'imbottitura della struttura è ottenuta con lastre di poliuretano espanso indeformabile a densità differenziate (25÷30 kg/m³) esente da CFC ricoperto da ovatta poliestere e vellutino accoppiato.

Base. In massello di noce canaletto con finitura a effetto cera.

Rivestimento. Disponibile in tessuto e pelle; non sfoderabile.

Frame. In solid poplar heartwood ("naturally" seasoned for at least 3 years); dap joints with cylindrical dowels. The webbing is secured by elastic polypropylene and natural latex belts. The framework is upholstered with contoured sheets of resilient, CFC-free polyurethane foam (with density of 25÷30 kg/m³) covered by polyester wadding and bonded plush.

Base. In solid black walnut heartwood with "wax effect" finishing.

Covers. Available in fabric or leather; non removable covers.



WOODY0POLTRON

- I Poltrona.
- E Armchair.
- F Fauteuil.
- D Sessel.
- S Butaca.

cm. 69 x 80 x h 78 – hs 41 • mt. 1.90
in. 27¹/₄ x 31¹/₂ x h 30³/₄ – hs 16¹/₂ • yd. 2.10

COM	1.859,00
L	1.894,00
T	1.936,00
S	1.971,00
Z	2.014,00
K	2.049,00
PS	2.172,00
PF	2.299,00
PX	2.503,00
PA	2.694,00



WOODY0DIVANET

- I Divano.
- E Sofa.
- F Canapé.
- D Sofa.
- S Sofá.

cm. 130 x 80 x h 78 – hs 41 • mt. 3.30
in. 51¹/₄ x 31¹/₂ x h 30³/₄ – hs 16¹/₂ • yd. 3.60

COM	2.634,00
L	2.699,00
T	2.777,00
S	3.092,00
Z	2.919,00
K	2.984,00
PS	3.203,00
PF	3.437,00
PX	3.811,00
PA	4.161,00



WOODY0BRACCUO

- I Elementi in acciaio verniciato, intrecciati in corda di cuoio per ogni coppia di braccioli.
- E Elements in varnished steel, woven with saddle leather cord for each pair of armrests.
- F Éléments en acier verni, tissés avec cordon en cuir épais pour chaque paire d'accoudoirs.
- D Elemente aus lackiertem Stahl, mit Rindleder cordel für jedes Paar Armlehnen gewebt.
- S Elementos en acero pintado, tejidos con cordón de cuero para cada par de reposabrazos.

cm. 56,5 x 2 x h 26,5
in. 22¹/₄ x 3/4" x h 10¹/₂

487,00

CUSCINI OPTIONAL



Imbottitura. In piuma.
Rivestimento. Disponibile in tessuto e pelle; sfoderabile.

Upholstery. In feather
Covers. Available in fabric or leather; removable covers.

	<p>OPTIONCUSSA30</p> <p>I Cuscinetto a saponetta cm. 30x30. E Cushion knife edge cm. 30x30. F Coussin ovale cm. 30x30. D Seife Kissen cm. 30x30. S Cojín tipo "jabón" cm. 30x30.</p> <p>cm. 30 x 30 x h 15 • mt. 0.35 in. 11³/₄ x 11³/₄ x h 5⁷/₈ • yd. 0.40</p>	COM	129,00
		L	136,00
		T	144,00
		S	151,00
		Z	161,00
		K	168,00
		PS	176,00
		PF	200,00
		PX	238,00
		PA	274,00
	<p>OPTIONCUSSA40</p> <p>I Cuscinetto a saponetta cm. 40x40. E Cushion knife edge cm. 40x40. F Coussin ovale cm. 40x40. D Seife Kissen cm. 40x40. S Cojín tipo "jabón" cm. 40x40.</p> <p>cm. 40 x 40 x h 15 • mt. 0.45 in. 15³/₄ x 15³/₄ x h 5⁷/₈ • yd. 0.50</p>	COM	145,00
		L	157,00
		T	169,00
		S	180,00
		Z	193,00
		K	203,00
		PS	199,00
		PF	228,00
		PX	273,00
		PA	316,00
	<p>OPTIONCUSFA40</p> <p>I Cuscinetto con fascia cm. 40x40. E Cushion with band cm. 40x40. F Coussin à plate-bande cm. 40x40. D Kissen mit Band cm. 40x40. S Cojín con banda cm. 40x40.</p> <p>cm. 40 x 40 x h 15 • mt. 0.50 in. 15³/₄ x 15³/₄ x h 5⁷/₈ • yd. 0.55</p>	COM	177,00
		L	187,00
		T	201,00
		S	211,00
		Z	225,00
		K	235,00
		PS	231,00
		PF	259,00
		PX	305,00
		PA	347,00
	<p>OPTIONCUSSA50</p> <p>I Cuscinetto a saponetta cm.50x50. E Cushion knife edge cm. 50x50. F Coussin ovale cm. 50x50. D Seife Kissen cm. 50x50. S Cojín tipo "jabón" cm. 50x50.</p> <p>cm. 50 x 50 x h 15 • mt. 0.55 in. 19³/₄ x 19³/₄ x h 5⁷/₈ • yd. 0.60</p>	COM	162,00
		L	174,00
		T	191,00
		S	203,00
		Z	219,00
		K	232,00
		PS	232,00
		PF	267,00
		PX	324,00
		PA	378,00

CUSCINI OPTIONAL



OPTIONCUSFA50

I Cuscinetto con fascia cm. 50x50.
 E Cushion with band cm. 50x50.
 F Coussin à plate-bande cm. 50x50.
 D Kissen mit Band cm. 50x50.
 S Cojín con banda cm. 50x50.

cm. 50 x 50 x h 15 • mt. 0.60
 in. 19³/₈ x 19³/₈ x h 5⁷/₈ • yd. 0.65

COM	198,00
L	210,00
T	227,00
S	239,00
Z	255,00
K	268,00
PS	268,00
PF	303,00
PX	361,00
PA	414,00



OPTIONCUS5040

I Cuscinetto con fascia cm. 50x40.
 E Cushion with band cm. 50x40.
 F Coussin à plate-bande cm. 50x40.
 D Kissen mit Band cm. 50x40.
 S Cojín con banda cm. 50x40.

cm. 50 x 40 x h 15 • mt. 0.55
 in. 19³/₈ x 15³/₈ x h 5⁷/₈ • yd. 0.60

COM	123,00
L	136,00
T	152,00
S	166,00
Z	181,00
K	195,00
PS	209,00
PF	247,00
PX	334,00
PA	397,00

KIT PULIZIA PELLE / CUIOIO

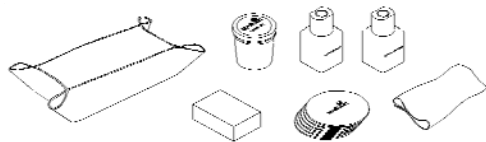

KIT00000PULIZIA

I Kit pulizia per pelle e cuoio contenente: vaschettina svuotatasche in cuoio cm. 20x10x5h., lucido colore con relativa spugnetta, Leather Protector e Leather Cleaner con relativa spugnetta, 6 sottobicchieri in cuoio e panno pulizia.
 E Cleaning kit for leather and saddle leather including: saddle leather basin cm. 20x10x5h., coloured polish cream and the relative small sponge, Leather Protector and Leather Cleaner with the relative small sponge, 6 saddle leather coasters and a polish cloth.
 F Ensemble pour l'entretien du cuir contenant: porte objets en cuir cm. 20x10x5h., cirage de couleur avec petite éponge, Leather Protector et Leather Cleaner avec petite éponge, 6 dessous-de-verre en cuir et chiffon.
 D Pflege – Satz für Leder und Rindleder enthaltend: Wännchen in Leder cm. 20x10x5h., glanze Creme mit bezüglichliche Schwamm, Leather Protector und Leather Cleaner mit bezüglichliche Schwamm, 6 Rindleder Glasuntersätze und Tuch für die Säuberung.
 S Kit de mantenimiento para piel y cuero contiene: porta objetos de cuero cm 20x10x5 h.; reparador de color con pequeña esponja protector de la piel con pequeña esponja, 6 posavasos de cuero y paño de pulido.

175,00

**SEDIE TAVOLI LIBRERIE MOBILI SCRITTOI
CHAIRS TABLES BOOKCASE CABINETS WRITIMG DESKS
CHAISES TABLES BIBLIOTHEQUES MEUBLES BUREAUX
STÜHLEN TISCHEN REGAL SCHRÄNKE SCHREIBTISCH
SILLAS MESAS BIBLIOTECAS MEUBLES ESCRITORIOS**

ARTUR - Design Umberto Asnago



Piano. In pannello nobilitato impiallacciato in essenza di noce canaletto con finitura "effetto cera"; sportello rivestito in cuoio o pelle e con parte inferiore con specchio. Vano interno rivestito in cuoio o pelle.

Gambe. In pannello multistrato di betulla curvato in stampo e rivestito in cuoio o pelle. Dettaglio laterale e piede in legno massello di pioppo impiallacciato in noce canaletto con finitura "effetto cera".

Top. In melamine coated panel veneered in black walnut wood with "wax effect" finishing; a small door is fixed in the middle of the top and is covered in saddle leather or leather with lower part with mirror. Small storage compartment covered in saddle leather or leather.

Legs. In birch plywood panel curved into a mould and covered in saddle leather or leather. Side detail and foot in solid poplar wood veneered in black walnut wood with "wax effect" finishing

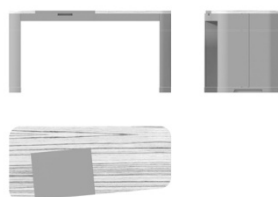

ARTUROSCRIT01

- I Scrivitoio rivestito in pelle o cuoio con piano, piedi e profilo in noce canaletto.
- E Writing desk covered in leather or saddle leather, top, feet and details in black walnut wood.
- F Bureau recouvert en cuir souple ou en cuir épais, avec plan, pieds et profils en noyer d'Amérique.
- D Schreibtisch in Leder oder Rindleder gepolstert mit Platte, Fusse und Kante in Amerikanische Nussbaumholz.
- S Escritorio tapizado en piel también en cuero, con tapa, pies y perfiles en nogal americano.

cm. 150 x 70 x h 76
in. 59" x 27"½ x h 29"¾

CV	6.033,00
CF	5.427,00
CS	4.670,00
PA	5.821,00
PX	5.366,00
PF	4.882,00
PS	4.579,00



ARTUROSCRIT02

- I Ripiano superiore con 2 contenitori in noce canaletto e pelle o cuoio.
- E Upper shelf with 2 cases in black walnut wood and leather or saddle leather.
- F Tablette supérieure avec 2 récipients en noyer d'Amérique et cuir souple ou épais.
- D Obere Boden mit 2 Container in Amerikanische Nussbaumholz und Leder oder Rindleder.
- S Estante superior con 2 contenedores en nogal americano, piel o también en cuero.

cm. 103 x 23 x h 10
in. 40"½ x 9" x h 3"¾

CV	964,00
CF	933,00
CS	895,00
PA	953,00
PX	930,00
PF	906,00
PS	891,00



ARTUROSCRIT03

- I Ripiano inferiore con un contenitore in noce canaletto e pelle o cuoio.
- E Lower shelf with one case in black walnut wood and leather or saddle leather.
- F Tablette inférieure avec 1 récipient en noyer d'Amérique et cuir souple ou épais.
- D Untere Boden mit 1 Container in Amerikanische Nussbaumholz und Leder oder Rindleder.
- S Estante inferior con 1 contenedor en nogal americano, piel o también en cuero.

cm. 40 x 50 x h 9
in. 15"¾ x 19"¾ x h 3"¾

CV	771,00
CF	745,00
CS	713,00
PA	762,00
PX	743,00
PF	722,00
PS	709,00

ASCOT - Design Umberto Anago



Piano. E' costituito da un sottopiano su cui poggia il piano vero e proprio. Il sottopiano è in pannello nobilitato con bordo impiallacciato in essenza di noce canaletto con finitura "effetto cera"; il piano è disponibile in: a) marmo diviso in 3 sezioni; b) in pannello nobilitato impiallacciato in essenza di noce canaletto con finitura "effetto cera" e intarsiato. Al centro del piano è poi fissato in piano lazy susan girevole in cristallo retro verniciato in colore RAL a scelta.

Gambe. In legno massello di noce canaletto con finitura "effetto cera", con fianchi rivestiti in cuoio.

Top. Is composed by a sub top on which is fixed the real top. The sub top is in melamine coated panel with the edge veneered in black walnut wood with "wax effect" finishing; the top is available: a) in marble divided in 3 sections; b) in melamine coated panel veneered in black walnut wood with "wax effect" finishing and with crossed veneer. In the center there is a lazy susan top in glass painted underneath in RAL colors of your choice.

Legs. In solid black walnut wood with "wax effect" finishing, with side covered in saddle leather.

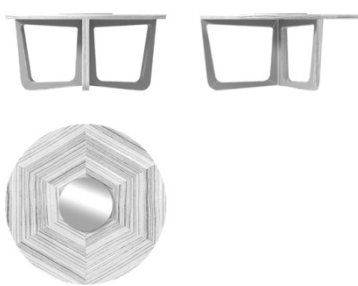

ASCOT0TA150ES

I Tavolo Ø cm. 150 in noce canaletto a venatura incrociata con ripiano girevole "lazy susan" in cristallo verniciato in colore RAL. Base in noce canaletto con inserto in cuoio.

E Table Ø cm. 150 in black walnut wood with crossed veneer and swivel lazy susan in glass painted in RAL colour. Base in black walnut wood with insert in saddle leather.

F Table Ø cm. 150 en noyer d'Amérique avec placage intersecté et insert tournant en verre verni en couleur RAL. Piètement en noyer d'Amérique avec revêtement en cuir épais.

D Tisch Ø cm. 150 in Amerikanische Nussbaum mit verkreuzter Maserung und drehbarem Einsatz aus RAL Farbe lackiert Glas. Gestell in Amerikanische Nussbaumholz mit Rindleder Detail.

S Mesa Ø cm. 150 en nogal Americano con chapa cruzado y con tapa giratoria "lazy susan" en vidrio pintado color RAL. Base en nogal americano con inserción de cuero.

cm. 150 x 150 x h 71
in. 59" x 59" x h 28"

CV 8.664,00
CF 8.431,00
CS 8.138,00

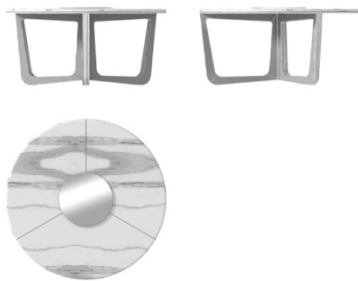

I Tavolo Ø cm. 150 in marmo calacatta oro o sahara noir (codice **ASCOT0TA150MC**) o Marron Damasco, nero marquina, marron emperador o bianco carrara gioia (codice **ASCOT0TA150MM**) con ripiano girevole "lazy susan" in cristallo verniciato in colore RAL. Base in noce canaletto con inserto in cuoio.

E Table Ø cm. 150 in Calacatta Oro or Sahara Noir Marble (code **ASCOT0TA150MC**) or in Marron Damasco, black Marquina, Marron Emperador or White Carrara Gioia marble (code **ASCOT0TA150MM**) and swivel lazy susan in glass painted in RAL colour. Base in black walnut wood with insert in saddle leather.

F Table Ø cm. 150 en marbre Calacatta Oro ou Sahara Noir (code **ASCOT0TA150MC**) ou en marbre Marron Damasco, noir Marquina, Marron Emperador ou blanc Carrara Gioia (code **ASCOT0TA150MM**) et insert tournant en verre verni en couleur RAL. Piètement en noyer d'Amérique avec revêtement en cuir épais.

D Tisch Ø cm. 150 in Calacatta Oro Marmor oder Sahara Noir Marmor (Code **ASCOT0TA150MC**) oder in Marmor Marron Damasco, Marmor Marquina schwarz, Marmor Marron Emperador oder weissen Marmor Carrara Gioia (Code **ASCOT0TA150MM**) und drehbarem Einsatz aus RAL Farbe lackiert Glas. Gestell in Amerikanische Nussbaumholz mit Rindleder Detail.

S Mesa Ø cm. 150 en mármol Calacatta oro o Sahara Noir (código **ASCOT0TA150MC**) o en mármol Marron Damasco, Marquina negro, Marron Emperador o bien blanco Carrara Gioia (código **ASCOT0TA150MM**) y con tapa giratoria "lazy susan" en vidrio pintado color RAL. Base en nogal americano con inserción de cuero.

cm. 150 x 150 x h 71
in. 59" x 59" x h 28"

	ASCOT0TA150MM	ASCOT0TA150MC
CV	8.354,00	10.907,00
CF	8.121,00	10.673,00
CS	7.829,00	10.381,00

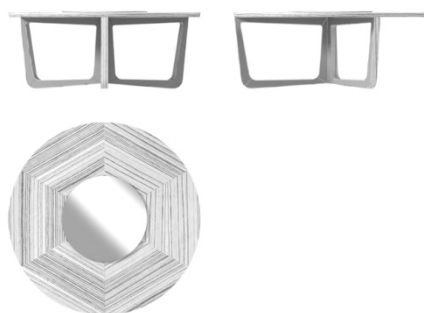

ASCOT0TA180ES

I Tavolo Ø cm. 180 in noce canaletto a venatura incrociata con ripiano girevole "lazy susan" in cristallo verniciato in colore RAL. Base in noce canaletto con inserto in cuoio.

E Table Ø cm. 180 in black walnut wood with crossed veneer and swivel lazy susan in glass painted in RAL colour. Base in black walnut wood with insert in saddle leather.

F Table Ø cm. 180 en noyer d'Amérique avec placage intersecté et insert tournant en verre verni en couleur RAL. Piètement en noyer d'Amérique avec revêtement en cuir épais.

D Tisch Ø cm. 180 in Amerikanische Nussbaum mit verkreuzter Maserung und drehbarem Einsatz aus RAL Farbe lackiert Glas. Gestell in Amerikanische Nussbaumholz mit Rindleder Detail.

S Mesa Ø cm. 180 en nogal Americano con chapa cruzado y con tapa giratoria "lazy susan" en vidrio pintado color RAL. Base en nogal americano con inserción de cuero.

cm. 180 x 180 x h 71
in. 70" x 70" x h 28"

CV 9.932,00
CF 9.673,00
CS 9.348,00

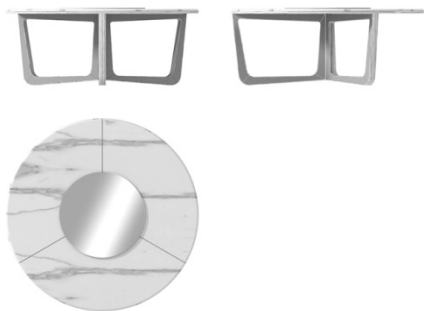

I Tavolo Ø cm. 180 in marmo calacatta oro o sahara noir (codice **ASCOT0TA180MC**) o Marron Damasco, nero marquina, marron emperador o bianco carrara gioia (codice **ASCOT0TA180MM**) con ripiano girevole "lazy susan" in cristallo verniciato in colore RAL. Base in noce canaletto con inserto in cuoio.

E Table Ø cm. 180 in Calacatta Oro or Sahara Noir Marble (code **ASCOT0TA180MC**) or in Marron Damasco, black Marquina, Marron Emperador or White Carrara Gioia marble (code **ASCOT0TA180MM**) and swivel lazy susan in glass painted in RAL colour. Base in black walnut wood with insert in saddle leather.

F Table Ø cm. 180 en marbre Calacatta Oro ou Sahara Noir (code **ASCOT0TA180MC**) ou en marbre Marron Damasco, noir Marquina, Marron Emperador ou blanc Carrara Gioia (code **ASCOT0TA180MM**) et insert tournant en verre verni en couleur RAL. Piètement en noyer d'Amérique avec revêtement en cuir épais.

D Tisch Ø cm. 180 in Calacatta Oro Marmor oder Sahara Noir Marmor (Code **ASCOT0TA180MC**) oder in Marmor Marron Damasco, Marmor Marquina schwarz, Marmor Marron Emperador oder weissen Marmor Carrara Gioia (Code **ASCOT0TA180MM**) und drehbarem Einsatz aus RAL Farbe lackiert Glas. Gestell in Amerikanische Nussbaumholz mit Rindleder Detail.

S Mesa Ø cm. 180 en mármol Calacatta oro o Sahara Noir (código **ASCOT0TA180MC**) o en mármol Marron Damasco, Marquina negro, Marron Emperador o bien blanco Carrara Gioia (código **ASCOT0TA180MM**) y con tapa giratoria "lazy susan" en vidrio pintado color RAL. Base en nogal americano con inserción de cuero.

cm. 180 x 180 x h 71
in. 70"½ x 70"½ x h 28"

	ASCOT0TA180MM	ASCOT0TA180MC
CV	9.794,00	CV 13.190,00
CF	9.535,00	CF 12.931,00
CS	9.210,00	CS 12.606,00

BABETTE - Design Umberto Anago



Struttura. In multistrato di pioppo curvato in stampo. L'imbottitura della struttura è ottenuta con una lastra di poliuretano espanso indeformabile con densità 50 kg/m³ esente da CFC.

Base. In massello di noce canaletto con finitura a "effetto cera".

Rivestimento. Disponibile in tessuto e pelle con profilo laterale sempre in pelle; non sfoderabile. Nella versione in pelle è dotata di una cucitura decorativa assente nella versione in tessuto.

Frame. In poplar plywood curved into a mould. The framework is upholstered with a contoured sheet of resilient, CFC-free polyurethane foam with density of 50 kg/m³.

Base. In solid black walnut heartwood with "wax effect" finishing.

Covers. Available in fabric or leather with piping always in leather; non removable covers. In the leather version it has a decorative stitching that is absent in the fabric version.



BABETTSEDIA01

I Sedia imbottita con struttura in noce canaletto.

E Upholstered chair with black walnut frame.

F Chaise rembourrée avec structure en noyer d'Amérique.

D Gepolstert Stuhl mit Gestell in Amerikanische Nussbaum.

S Silla rellena con estructura en nogal americano.

cm. 48.5 x 61 x h 84 – hs 46 • mt. 1.20
in. 19¹/₂ x 24" x h 33¹/₂" – hs 18¹/₂" • yd. 1.30

COM	1.137,00
L	1.160,00
T	1.187,00
S	1.209,00
Z	1.237,00
K	1.260,00
PS	1.338,00
PF	1.420,00
PX	1.551,00
PA	1.675,00



BABETTSEDIA02

I Sedia imbottita con struttura in faggio laccata bianca o nera.

E Upholstered chair with beech wood frame varnished black or white.

F Chaise rembourrée avec structure en hêtre laquée blanche ou noire.

D Gepolstert Stuhl mit Gestell in Buche schwarzem oder weissem lackiert.

S Silla rellena con estructura en haya pintada en negro o blanco.

cm. 48.5 x 61 x h 84 – hs 46 • mt. 1.20
in. 19¹/₂ x 24" x h 33¹/₂" – hs 18¹/₂" • yd. 1.30

COM	1.213,00
L	1.236,00
T	1.263,00
S	1.285,00
Z	1.312,00
K	1.335,00
PS	1.413,00
PF	1.496,00
PX	1.627,00
PA	1.751,00

BEAT - Design Alessandro Dubini



Struttura. In pannello nobilitato impiallacciato in essenza. Gli schienali di alcuni vani sono rivestiti in cuoio. Contenitori in cuoio.

Essenze. Disponibili le seguenti essenze: a) essenza tipo rovere naturale, b) essenza tipo rovere moro; c) essenza tipo rovere titanio. Altre finiture disponibili su richiesta.

Frame. In melamine coated panel veneered. The backrests are covered in saddle leather. Container in saddle leather.

Wood finishes. Available the following wood veneers: a) natural oak type wood; b) dark brown oak type wood; c) titanium oak type wood. Other finishes are available on request.

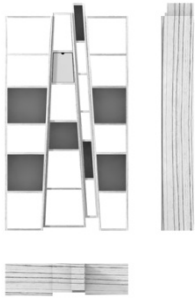

BEAT00LIBR115

I Scaffale in essenza di rovere sbiancato, moro o grigio con alcuni schienali in cuoio.

E Bookcase in oak wood bleached, dark brown or grey with some back in saddle leather.

F Etagère en placage de rouvre blanchi, foncé ou gris avec quelques dossiers en cuir épais

D Regal in gebleicht Eichenholz, dunkel oder grau mit einigen Ruecken in Rindlder.

S Estantería en madera de roble blanqueado, negro o gris con respaldos en cuero.

4.210,00

cm. 115 x 30 x h 212
in. 45³/₄ x 11³/₄ x h 83³/₄

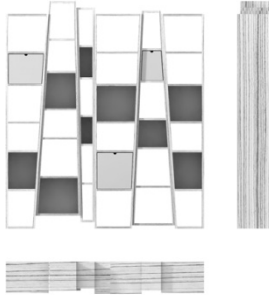

BEAT00LIBR185

I Scaffale in essenza di rovere sbiancato, moro o grigio con alcuni schienali in cuoio.

E Bookcase in oak wood bleached, dark brown or grey with some back in saddle leather.

F Etagère en placage de rouvre blanchi, foncé ou gris avec quelques dossiers en cuir épais

D Regal in gebleicht Eichenholz, dunkel oder grau mit einigen Ruecken in Rindlder.

S Estantería en madera de roble blanqueado, negro o gris con respaldos en cuero.

6.246,00

cm. 185 x 30 x h 212
in. 72⁷/₈ x 11³/₄ x h 83³/₄

BEAT00CONTECU

I Contenitore in cuoio e pelle.

E Case in saddle lather and leather.

F Récipient en cuir épais et cuir souple

D Container in Rindleder und Leder.

S Contenedor en cuero y piel.

564,00

BEVERLY - Design Mauro Lipparini



Struttura. In poliuretano compatto Baydur® CSP realizzato in stampo accoppiato a una lastra di poliuretano espanso indeformabile ed esente da CFC con densità 70 kg/m³.

Base. Basamento fisso in acciaio disponibile in due versioni: a 4 gambe o a slitta. Disponibile in finitura cromata o verniciata a polveri epossidiche in colore RAL a scelta.

Rivestimento. Disponibile in cuoio, tessuto e pelle; non sfoderabile.

Frame. In rigid polyurethane Baydur® CSP made in mould and coupled with a sheet of resilient, CFC-free polyurethane foam with density of 70 kg/m³.

Base. Fixed base in steel available in two versions: with 4 legs or with slide base. Available chromed or epoxy powder painted in RAL colors of your choice.

Covers. Available in saddle leather, fabric or leather; non removable covers.



I Sedia rivestita in cuoio con basamento verniciato (VER) o cromato (CRO).
 E Dining chair covered in saddle leather with varnished feet (VER) or chromed feet (CRO).
 F Chaise recouverte en cuir épais avec pied verni (VER) ou chromé (CRO).
 D Stuhl in Rindleder mit Gestell lackiert (VER) oder verchromt (CRO).
 S Silla tapizada en cuero con pata pintada (VER) o cromada (CRO).

cm. 46 x 55 x h 80 – hs 44
 in. 18³/₈ x 21³/₈ x h 31³/₈ – hs 17³/₈

	BEVERLSECUOVE	BEVERLSECUOCR
CV	1.701,00	CV 1.848,00
CF	1.588,00	CF 1.736,00
CS	1.447,00	CS 1.594,00



BEVERLSEIMBVE
 I Sedia imbottita con basamento verniciato.
 E Dining upholstered chair with varnished feet.
 F Chaise rembourrée avec pied verni.
 D Gepolstert Stuhl mit Gestell lackiert.
 S Silla rellena con pata pintada.

cm. 46 x 55 x h 80 – hs 44 • mt. 0.65
 in. 18³/₈ x 21³/₈ x h 31³/₈ – hs 17³/₈ • yd. 0.70

COM	947,00
L	960,00
T	975,00
S	989,00
Z	1.004,00
K	1.018,00
PS	1.104,00
PF	1.154,00
PX	1.261,00
PA	1.343,00



BEVERLSEIMBCR
 I Sedia imbottita con basamento cromato.
 E Dining upholstered chair with chromed feet.
 F Chaise rembourrée avec pied chromé.
 D Gepolstert Stuhl mit Gestell verchromt.
 S Silla rellena con pata cromada.

cm. 46 x 55 x h 80 – hs 44 • mt. 0.65
 in. 18³/₈ x 21³/₈ x h 31³/₈ – hs 17³/₈ • yd. 0.70

COM	1.151,00
L	1.185,00
T	1.227,00
S	1.261,00
Z	1.303,00
K	1.337,00
PS	1.251,00
PF	1.301,00
PX	1.408,00
PA	1.489,00



BEVERLSE4GCVE
 I Sedia rivestita in cuoio con basamento verniciato (VE) o cromato (CR).
 E Dining chair covered in saddle leather with varnished feet (VE) or chromed feet (CR).
 F Chaise recouverte en cuir épais avec pied verni (VE) ou chromé (CR).
 D Stuhl in Rindleder mit Gestell lackiert (VE) oder verchromt (CR).
 S Silla tapizada en cuero con pata pintada (VE) o cromada (CR).

cm. 46 x 55 x h 80 – hs 44
 in. 18³/₈ x 21³/₈ x h 31³/₈ – hs 17³/₈

	BEVERLSE4GCVE	BEVERLSE4GCCR
CV	1.584,00	CV 1.634,00
CF	1.471,00	CF 1.521,00
CS	1.331,00	CS 1.380,00

BEVERLY - Design Mauro Lipparini



BEVERLSE4GIVE

I Sedia imbottita con basamento verniciato.
 E Dining upholstered chair with varnished feet.
 F Chaise rembourrée avec pied verni.
 D Gepolstert Stuhl mit Gestell lackiert.
 S Silla rellena con pata pintada.

cm. 46 x 55 x h 80 – hs 44 • mt. 0.65
 in. 18¹/₈ x 21³/₈ x h 31¹/₂ – hs 17³/₈ • yd. 0.70

COM	830,00
L	844,00
T	859,00
S	871,00
Z	888,00
K	900,00
PS	987,00
PF	1.037,00
PX	1.144,00
PA	1.226,00



BEVERLSE4GICR

I Sedia imbottita con basamento cromato.
 E Dining upholstered chair with chromed feet.
 F Chaise rembourrée avec pied chromé.
 D Gepolstert Stuhl mit Gestell verchromt.
 S Silla rellena con pata cromada.

cm. 46 x 55 x h 80 – hs 44 • mt. 0.65
 in. 18¹/₈ x 21³/₈ x h 31¹/₂ – hs 17³/₈ • yd. 0.70

COM	880,00
L	893,00
T	908,00
S	922,00
Z	937,00
K	950,00
PS	1.086,00
PF	1.151,00
PX	1.255,00
PA	1.351,00

CLAP - Design Umberto Asnago



Struttura. In massello di noce canaletto con finitura a "effetto cera". Elementi di giunzione in acciaio cromato.

Rivestimento. Disponibile solo in cuoio.

Frame. In solid black walnut heartwood with "wax effect" finishing. The junctions are in chromed steel.

Covers. Available only in saddle leather.



CLAP00SEDIA01

I Sedia "regista" pieghevole in noce canaletto e cuoio.

E Folding "director" chair in black walnut wood and saddle leather.

F Chaise "directeur" pliante en noyer d'Amerique et cuir épais.

D Klapstuhl "Direktor" mit Amerikanische Nussbaum und Rindleder.

S Silla de "director" plegable en nogal americano y cuero.

CV 2.236,00

CF 2.181,00

CS 2.113,00

cm. 61 x 53 x h 84 – hs 50
in. 24" x 20" x h 33" – hs 19"

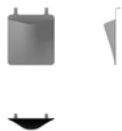

CLAP00TASCA00

I Portariviste in cuoio.

E Magazine rack in saddle leather.

F Porte-revues en cuir épais

D Zeitschriftenständer in Rindleder.

S Revistero en cuero.

CV 283,00

CF 232,00

CS 167,00

cm. 30 x 7 x h 38
in. 11" x 2" x h 15"

CROSSING - Design Luca Scacchetti



Struttura. In pannello nobilitato impiallacciato. Disponibile anche un top supplementare sempre impiallacciato con supporti laterali rivestiti in pelle o cuoio.

Essenze. Disponibile in essenza di tipo palissandro. Altre finiture disponibili su richiesta.

Frame. In melamine coated panel veneered. Available also an extra top in the same finish, with side supports covered in leather or saddle leather.

Wood finishes. Available in rosewood type wood. Other finishes are available on request.

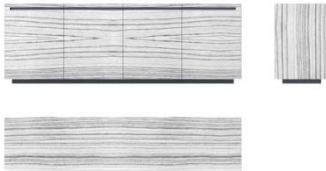

CROSSIM1520ES

I Mobile basso a 4 vani in essenza di palissandro con 4 ante.
 E 4 units low cabinet in rosewood with 4 doors.
 F Meuble bas à 4 éléments en placage de palissandre avec 4 portes.
 D 4 Raeume niedrige Schrank in Palissander Holz mit 4 Tueren.
 S Mueble bajo de 4 módulos en madera de palisandro con 4 puertas.

7.835,00

cm. 220 x 50 x h 74
 in. 86³/₈ x 19³/₈ x h 29³/₈



CROSSIM1521ES

I Mobile basso a 4 vani in essenza di palissandro con 2 ante e 3 cassetti.
 E 4 units low cabinet in rosewood with 2 doors and 3 drawers.
 F Meuble bas à 4 éléments en placage de palissandre avec 2 portes et 3 tiroirs.
 D 4 Raeume niedrige Schrank in Palissander Holz mit 2 Tueren und 3 Schubladen.
 S Mueble bajo de 4 módulos en madera de palisandro con 2 puertas et 3 cajones.

7.801,00

cm. 220 x 50 x h 74
 in. 86³/₈ x 19³/₈ x h 29³/₈



CROSSIM1522CU

I Top per mobile basso a 4 vani completamente rivestito in cuoio o pelle.
 E Top for 4 units low cabinet completely covered in saddle leather or soft leather.
 F Plan pour meuble bas à 4 éléments entièrement recouvert en cuir épais ou cuir souple.
 D Abdeckplatte fuer 4 Raeume niedrige Schrank komplett bezogen in Rindleder oder in Leder.
 S Encimera para mueble bajo de 4 módulos completamente tapizada en cuero o en piel.

CV 2.422,00
 CF 2.149,00
 CS 1.809,00
 PA 2.326,00
 PX 2.122,00
 PF 1.903,00
 PS 1.767,00

cm. 226 x 50 x h 23
 in. 89¹/₈ x 19³/₈ x h 9¹/₈



CROSSIM1522ES

I Top per mobile basso a 4 vani in essenza di palissandro con supporti in cuoio o pelle.
 E Top for 4 units low cabinet in rosewood with 2 support in saddle leather or soft leather.
 F Plan pour meuble bas à 4 éléments en placage de palissandre avec 2 supportes en cuir épais ou cuir souple.
 D Abdeckplatte fuer 4 Raeume niedrige Schrank in Palissander Holz mit 2 Traegern in Rindleder oder in Leder.
 S Encimera para mueble bajo de 4 módulos en madera de palisandro con 2 apoyos en cuero o en piel.

CV 2.597,00
 CF 2.433,00
 CS 2.229,00
 PA 2.540,00
 PX 2.416,00
 PF 2.286,00
 PS 2.204,00

cm. 226 x 50 x h 23
 in. 89¹/₈ x 19³/₈ x h 9¹/₈



Struttura. Montanti verticali in pannello nobilitato rivestiti in cuoio o pelle con fasce in acciaio cromato. Ripiani in pannello nobilitato impiallacciati in essenza.
Essenze. Disponibili le seguenti essenze: a) ebano macassar; b) noce canaletto rigato; c) tipo rovere moro. Altre finiture disponibili su richiesta.

Frame. Vertical frames are in melamine coated panel covered in saddle leather or leather with sheets in chromed steel. Shelves and doors (optional) are in melamine coated panel veneered.
Wood finishes. Available the following wood veneers: a) macassar ebony wood; b) striped black walnut wood; c) dark brown oak type wood. Other finishes are available on request.

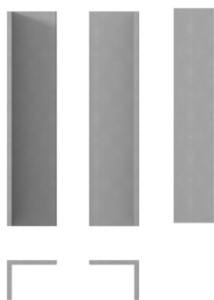

ELLE00SPAMURO

I Spalle in cuoio o pelle per libreria a muro.
 E Side panels in leather or saddle leather for bookcase.
 F Panneaux latéraux en cuir épais ou cuir souple pou étagère.
 D Seiten Paneelen in Rindleder oder in Leder fuer Regal.
 S Paneles laterales en cuero o en piel para la estantería.

CV	5.749,00
CF	5.094,00
CS	4.275,00
PA	5.519,00
PX	5.028,00
PF	4.504,00
PS	4.176,00

cm. 46 x 37 x h 199
 in. 18"½ x 14"½ x h 78"¾

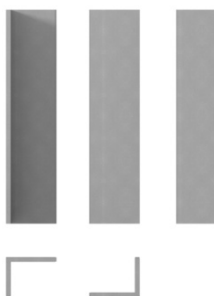

ELLE00SPACEDX

I Spalle in cuoio o pelle per libreria destra a centro stanza.
 E Side panels in leather or saddle leather for two faced right bookcase.
 F Panneaux latéraux en cuir épais ou cuir souple pou étagère droite finie sur les deux côtés.
 D Seiten Paneelen in Rindleder oder in Leder fuer doppelgesichtig Regal rechts.
 S Paneles laterales en cuero o en piel para estantería derecha de dos caras.

CV	6.758,00
CF	5.867,00
CS	4.754,00
PA	6.446,00
PX	5.778,00
PF	5.066,00
PS	4.621,00

cm. 46 x 37 x h 199
 in. 18"½ x 14"½ x h 78"¾

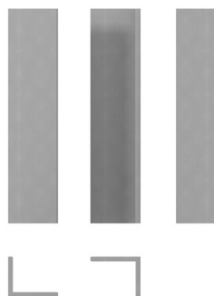

ELLE00SPACESX

I Spalle in cuoio o pelle per libreria sinistra a centro stanza.
 E Side panels in leather or saddle leather for two faced left bookcase.
 F Panneaux latéraux en cuir épais ou cuir souple pou étagère gauche finie sur les deux côtés.
 D Seiten Paneelen in Rindleder oder in Leder fuer doppelgesichtig Regal links.
 S Paneles laterales en cuero o en piel para estantería izquierda de dos caras.

CV	6.758,00
CF	5.867,00
CS	4.754,00
PA	6.446,00
PX	5.778,00
PF	5.066,00
PS	4.621,00

cm. 46 x 37 x h 199
 in. 18"½ x 14"½ x h 78"¾



I 5 ripiani in essenza di ebano macassar (EB), noce canaletto (NO) o rovere moro (RO).
 E 5 shelves in ebony macassar wood (EB), black walnut wood (NO) or dark brown oak wood (RO).
 F 5 tablettes en placage de ébène macassar (EB), de noyer d'Amerique (NO) ou de rouvre foncé (RO).
 D 5 Einlegeboden in Macassar Ebenholz (EB), in Amerikanische Nussbaumholz (NO) oder in Dunkeleichen (RO).
 S 5 estantes en madera de ébano Macassar (EB), de nogal negro (NO) o de roble marrón oscuro (RO).

cm. 172 x 32 x h 3
 in. 67"¾ x 12"¾ x h 1"¼

ELLE00PIANIEB
 4.930,00

ELLE00PIANINO
 4.131,00

ELLE00PIANIRO
 3.099,00

ELLE - Design Matteo Nunziati



ELLE00ANTE000

I 4 ante in cuoio o pelle per libreria a muro.
 E 4 doors in leather or saddle leather for bookcase.
 F 4 portes en cuir épais ou cuir souple pour étagère.
 D 4 Tueren in Rindleder oder in Leder fuer Regal.
 S 4 puertas en cuero o en piel para estantería de dos caras.

cm. 171.5 x 32 x h 45.5
 in. 67¹/₂ x 12¹/₂ x h 17¹/₂

CV	2.174,00
CF	2.045,00
CS	1.883,00
PA	2.129,00
PX	2.032,00
PF	1.928,00
PS	1.863,00



I 4 ante in essenza di ebano macassar (**EB**), noce canaletto (**NO**) o rovere moro (**RO**) per libreria a muro.
 E 4 doors in ebony macassar wood (**EB**), black walnut wood (**NO**), or dark brown oak wood (**RO**) for bookcase.
 F 4 portes en placage de ébène macassar (**EB**), de noyer d'Amérique (**NO**) ou de rouvre foncé (**RO**) pour étagère.
 D 4 Tueren in Macassar Ebenholz (**EB**), in Amerikanische Nussbaumholz (**NO**) oder in Dunkeleichen (**RO**) fuer Regal.
 S 4 puertas en madera de ébano Macassar (**EB**), de nogal negro (**NO**) o de roble marrón oscuro (**RO**) para estantería de dos caras.

cm. 171.5 x 32 x h 45.5
 in. 67¹/₂ x 12¹/₂ x h 17¹/₂

ELLE00ANTE0EB

2.083,00

ELLE00ANTE0NO

1.672,00

ELLE00ANTE0RO

1.447,00

ELLE00SEPARCU

I Separatore per libri in cuoio o pelle.
 E 4 doors in leather or saddle leather for bookcase.
 F 4 portes en cuir épais ou cuir souple pour étagère.
 D Trennscheide fuer Bucher in Rindleder oder in Leder.
 S Separador para libros en cuero o en piel.

cm. 20 x 26 x h 22
 in. 7¹/₂ x 10¹/₄ x h 8¹/₂

CV	245,00
CF	228,00
CS	206,00
PA	239,00
PX	227,00
PF	212,00
PS	204,00

EQUA - Design Matteo Nunziati



Struttura. In pannello nobilitato impiallacciato in essenza. Top e frontali dei cassetti rivestiti in cuoio o pelle; cassetti interni in multistrato di faggio laccato nero opaco. Fianchi in pannello nobilitato laccato con particolare finitura spazzolata a mano disponibile in colore: a) bronzo satinato; b) argento satinato; c) rame satinato.

Essenze. Disponibili le seguenti essenze: a) tipo rovere titanio; b) noce canaletto fiammato. Altre finiture disponibili su richiesta.

Base. In tubolare d'acciaio verniciata con particolare finitura spazzolata a mano disponibile in colore: a) bronzo satinato; b) argento satinato; c) rame satinato.

Frame. In melamine coated panel veneered in wood. Top and front of drawers covered in saddle leather or leather; drawers in beech plywood black lacquered matt. Side panels in melamine coated panel lacquered in a special hand-brushed finish available in color: a) satin bronze; b) satin silver; c) satin copper.

Wood finishes. Available the following wood veneers: a) titanium oak type; b) veined black walnut wood. Other finishes are available on request.

Base. In tubular steel painted in a special hand-brushed finish available in color: a) satin bronze; b) satin silver; c) satin copper.

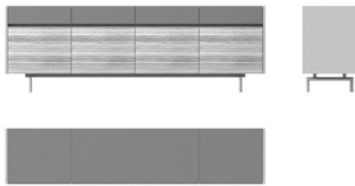

EQUA00MADI224

I Mobile in Titanium Oak o noce canaletto con top e 4 cassetti rivestiti in cuoio o pelle; 4 ante in Titanium Oak o noce canaletto. Fianchi verniciati in argento, bronzo o rame satinato; basamento in acciaio verniciato in colore titanio.

E Low cabinet in Titanium Oak or black walnut wood with top and 4 drawers covered in saddle leather or leather; 4 doors in Titanium Oak or black walnut wood. Side panels varnished in silver, bronze or copper satin color; feet in steel varnished in titanium colour.

F Meuble en Titanium Oak ou en noyer d'Amerique avec top et 4 tiroirs recouverts en cuir épais ou cuir souple; 4 portes en Titanium Oak ou en noyer d'Amerique. Panneaux latéraux verni en argent, bronze ou cuivre satiné; piétement en acier verni couleur titanium satiné.

D Schrank in Titanium Oak Holz oder Amerikanische Nussbaumholz mit Platte und 4 Schubladen in Rindleder oder Leder bezogen; 4 Tueren in Titanium Oak Holz oder Amerikanische Nussbaumholz. Seiten lackiertem Farbe Silber, Bronze oder satiniertes Kupfer; Gestell in lackiertem Stahl Farbe satiniert Titanium.

S Meuble bajo in Titanium Oak o en nogal americano con encimera y 4 cajones tapizados en cuero o piel; 4 puertas en Titanium Oak o en nogal americano. Lados pintado en color de plata, bronce o cobre satinado; base en acero pintado en color de Titanium satinado.

cm. 223.5 x 47 x h 67.5
in. 88" x 18"½ x h 26"½

CV	7.870,00
CF	7.524,00
CS	7.092,00
PA	7.749,00
PX	7.489,00
PF	7.212,00
PS	7.039,00

GRID - Design Matteo Nunziati



Struttura. In alluminio verniciato a polveri epossidiche colore titanio. Schienali e ripiani in pannello nobilitato disponibile in: a) impiallacciato in essenza; b) rivestito in cuoio o pelle; c) laccato in colore RAL a scelta con finitura lucida 100 gloss.

Essenze. Disponibili in essenze tipo rovere titanio. Altre finiture disponibili su richiesta.

Frame. In aluminum epoxy-powder painted in color titanium. Backrests and shelves in melamine coated panel available: a) veneered in wood; b) covered in saddle leather or leather; c) lacquered in RAL colors of your choice with hi-gloss finish 100 gloss.

Wood finishes. Available in titanium oak type wood veneer. Other finishes are available on request.



GRID00SPALLAT

I Spalla terminale in acciaio verniciato colore titanio.
 E Side panel for bookcase in steel colour titanium varnished.
 F Panneau latéral pour étagère en acier verni couleur titane.
 D Seiten Paneel fuer Regal in lackiertem Stahl titanium Farbe.
 S Panel lateral para la estantería en acero pintado en color de titanio.

1.125,00

cm. 40 x 3 x h 230
 in. 15³/₄ x 1¹/₄ x h 90¹/₂



GRID00SPALLAC

I Spalla centrale in acciaio verniciato colore titanio.
 E Central panel for bookcase in steel colour titanium varnished.
 F Panneau central pour étagère en acier verni couleur titane.
 D Zentral Paneel fuer Regal in lackiertem Stahl titanium Farbe.
 S Panel central para la estantería en acero pintado en color de titanio.

1.125,00

cm. 40 x 3 x h 230
 in. 15³/₄ x 1¹/₄ x h 90¹/₂



GRID00SCHIEES

I Modulo schienale in Titanium Oak.
 E Back panel in Titanium Oak.
 F Panneau arrière en Titanium Oak.
 D Rückseite Paneel in Titanium Oak Holz.
 S Panel posterior en Titanium Oak.

1.344,00

cm. 118 x 3 x h 230
 in. 46¹/₂ x 1¹/₄ x h 90¹/₂



GRID00SCHIECU

I Modulo schienale in cuoio o pelle.
 E Back panel in saddle leather or leather.
 F Panneau arrière en cuir épais ou cuir souple.
 D Rückseite Paneel in Rindleder oder in Leder bezogen.
 S Panel posterior en cuero o piel.

CV 2.014,00
 CF 1.728,00
 CS 1.371,00
 PA 1.914,00
 PX 1.700,00
 PF 1.471,00
 PS 1.329,00

cm. 118 x 3 x h 230
 in. 46¹/₂ x 1¹/₄ x h 90¹/₂

GRID - Design Matteo Nunziati



GRID00SCHIELA

I Modulo schienale laccato in colore RAL a scelta del cliente. Finitura lucida spazzolata hi-gloss.
 E Back panel lacquered in RAL colour at client's choice. Brushed glossy finish hi-gloss.
 F Panneau arrière lacqué en couleur RAL choisi par le client. Finition brillante brossée hi-gloss.
 D Rückseite Paneel in lackiert in RAL Farbe nach Wahl. Gebuerstete hi-gloss polierte Oberfläche.
 S Panel posterior pintado en color RAL eligido por el cliente. Pulidura brillante cepillada hi-gloss.

2.644,00

cm. 118 x 3 x h 230
 in. 46¹/₂ x 1¹/₄ x h 90¹/₂



GRID00RIPIAES

I 5 ripiani in Titanium Oak necessari per ogni modulo schienale.
 E 5 shelves in Titanium Oak suitable for every back panel.
 F 5 tablettes en Titanium Oak nécessaires pour chaque panneau arrière.
 D 5 Einlegeboden in Titanium Oak Holz für jede Rückseite Paneel.
 S 5 estantes en Titanium Oak necesarios para cada panel posterior.

2.513,00

cm. 118 x 38 x h 4
 in. 46¹/₂ x 15" x h 1¹/₂



GRID00RIPIACU

I 5 ripiani in cuoio o pelle necessari per ogni modulo schienale.
 E 5 shelves in saddle leather or leather suitable for every back panel.
 F 5 tablettes en cuir épais ou cuir souple nécessaires pour chaque panneau arrière.
 D 5 Einlegeboden in Rindleder oder Leder bezogen für jede Rückseite Paneel.
 S 5 estantes en cuero o piel necesarios para cada panel posterior.

CV 3.598,00
 CF 3.053,00
 CS 2.371,00
 PA 3.407,00
 PX 2.998,00
 PF 2.562,00
 PS 2.290,00

cm. 118 x 38 x h 4
 in. 46¹/₂ x 15" x h 1¹/₂



GRID00RIPIALA

I 5 ripiani laccati in colore RAL a scelta del cliente necessari per ogni modulo schienale. Finitura lucida spazzolata hi-gloss.
 E 5 shelves lacquered in RAL colour at client's choice suitable for every back panel. Brushed glossy finish hi-gloss.
 F 5 tablettes lacquée en couleur RAL choisi par le client nécessaires pour chaque panneau arrière. Finition brillante brossée hi-gloss.
 D 5 Einlegeboden in lackiert in RAL Farbe nach Wahl für jede Rückseite Paneel. Gebuerstete hi-gloss polierte Oberfläche.
 S 5 estantes pintados en color RAL eligido por el cliente necesarios para cada panel posterior. Pulidura brillante cepillada hi-gloss.

3.129,00

cm. 118 x 38 x h 4
 in. 46¹/₂ x 15" x h 1¹/₂

LIV - Design Alessandro Dubini



Struttura. In multistrato di faggio curvato in stampo. L'imbottitura della struttura è ottenuta con una lastra di poliuretano espanso indeformabile esente da CFC e con densità 25 kg/m³ per lo schienale e 30 kg/m³ per la seduta e rivestita con ovatta poliestere.

Base. In massello di noce canaletto con finitura a "effetto cera".

Rivestimento. Disponibile in tessuto e pelle anche in versione combinata. Il profilo laterale è sempre in pelle; non sfoderabile.

Frame. In beech plywood curved into a mould. The framework is upholstered with a contoured sheet of resilient, CFC-free polyurethane foam with density of 25 kg/m³ for the backrest and of 30 kg/m³ for the seat, and covered by polyester wadding.

Base. In solid black walnut heartwood with "wax effect" finishing.

Covers. Available in fabric or leather also in mixed version. The piping is always in leather; non removable covers.



LIV000SEDIA01

I Sedia imbottita con gambe in noce canaletto.

E Upholstered chair with legs in black walnut.

F Chaise rembourrée avec pieds en noyer d'Amerique.

D Gepolstert Stuhl mit Beinen in Amerikanische Nussbaum.

S Silla rellena con patas en nogal americano.

cm. 57 x 53 x h 79 – hs 49 • mt. 1.75

in. 22¹/₂ x 20¹/₂ x h 31¹/₂ – hs 19¹/₄ • yd. 1.91

COM	1.920,00
L	1.951,00
T	1.988,00
S	2.019,00
Z	2.057,00
K	2.088,00
PS	2.188,00
PF	2.297,00
PX	2.471,00
PA	2.635,00

LOOP - Design Pierluigi Molinari



Struttura. Struttura perimetrale in pannello nobilitato rivestita in cuoio. Ripiani in pannello nobilitato impiallacciati in essenza.

Essenze. Disponibile in essenza di noce canaletto rigato. Altre finiture disponibili su richiesta.

Frame. Frame in melamine coated panel covered in saddle leather. Shelves in melamine coated panel veneered.

Wood finishes. Available in striped black walnut wood. Other finishes are available on request.

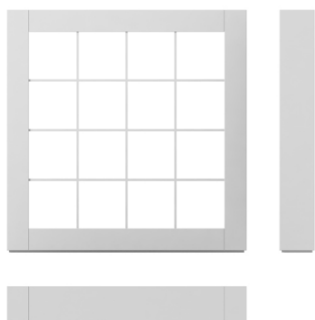

LOOP00000668

I Scaffale.
E Bookcase.
F Etagère.
D Regal.
S Estantería.

CV 8.816,00
CF 7.999,00
CS 6.979,00

cm. 218 x 32 x h 220
in. 85³/₄ x 12³/₄ x h 86³/₄

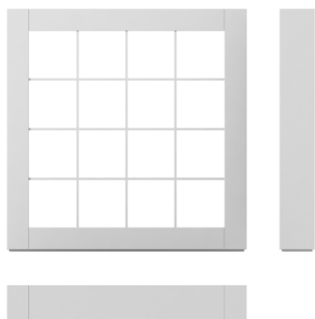

LOOP00000669

I Scaffale bifronte .
E Two-faced bookcase.
F Etagère à placer au milieu des locaux.
D Zweigesichtiger Regal.
S Estantería diáfana.

CV 10.398,00
CF 9.216,00
CS 7.739,00

cm. 218 x 32 x h 220
in. 85³/₄ x 12³/₄ x h 86³/₄

MAGISTRA - Design Alessandro Dubini



Struttura. In massello di rovere; schienale in multistrato di faggio curvato in stampo. La seduta è disponibile: a) imbottita con poliuretano espanso indeformabile esente da CFC e con densità 40 kg/m³ e rivestita in pelle o tessuto; b) in multistrato di faggio curvato in stampo.

Essenze. Disponibile in essenza di rovere con finitura: a) rovere sbiancato; b) rovere tinto grigio antracite; c) rovere tinto moro. Altre finiture disponibili su richiesta.

Frame. In solid oak heartwood; backrest in beech plywood curved into a mould. The seat is available: 2) upholstered with a contoured sheet of resilient, CFC-free polyurethane foam with density of 40 kg/m³ and covered in fabric, leather or saddle leather; b) in beech plywood panel curved into a mould.

Wood finishes. Available in oak wood with finishing: a) bleached oak wood; b) dark grey oak wood; c) dark brown oak wood. Other finishes are available on request.



MAGISTSEDIACU

I Sedia con braccioli in rovere sbiancato, moro o grigio con seduta in cuoio.
 E Chair with arms in oak wood bleached, dark brown or grey with seat in saddle leather.
 F Chaise avec accoudoirs en rouvre blanchi, foncé ou gris avec assise en cuir épais.
 D Stuhl mit Armlehnen in gebleicht Eichenholz, dunkel oder grau mit Rindleder Sitzung
 S Silla con brazos en madera de roble blanqueado, negro o gris y asiento en cuero.

CV 914,00
 CF 874,00
 CS 826,00

cm. 56 x 54 x h 77 – hs 46
 in. 22" x 21"¼ x h 30"¾ – hs 18"¾



MAGISTSEDIAES

I Sedia con braccioli interamente in rovere sbiancato, moro o grigio.
 E Chair with arms completely in oak wood bleached, dark brown or grey.
 F Chaise avec accoudoirs entièrement en rouvre blanchi, foncé ou gris.
 D Stuhl mit Armlehnen komplett in gebleicht Eichenholz, dunkel oder grau.
 S Silla con brazos totalmente en madera de roble blanqueado, negro o gris.

682,00

cm. 56 x 54 x h 77 – hs 44
 in. 22" x 21"¼ x h 30"¾ – hs 17"¾



MAGISTSEDIAIM

I Sedia con braccioli in rovere sbiancato, moro o grigio con seduta imbottita.
 E Chair with arms in oak wood bleached, dark brown or grey with upholstered seat.
 F Chaise avec accoudoirs en rouvre blanchi, foncé ou gris avec assise rembourrée.
 D Stuhl mit Armlehnen in gebleicht Eichenholz, dunkel oder grau mit gepolsterte Sitzung.
 S Silla con brazos en madera de roble blanqueado, negro o gris y asiento relleno.

COM 771,00
 L 782,00
 T 793,00
 S 803,00
 Z 815,00
 K 824,00
 PS 820,00
 PF 839,00
 PX 870,00
 PA 899,00

cm. 56 x 54 x h 77 – hs 47 • mt. 0.60
 in. 22" x 21"¼ x h 30"¾ – hs 18"¾ • yd. 0.65

MARLENE - Design Creative Group



Struttura. In tubolare d'acciaio imbottita con poliuretano espanso indeformabile esente da CFC e con densità 75 kg/m³ e rivestita in cuoio.

Frame. In tubular steel upholstered with a contoured sheet of resilient, CFC-free polyurethane foam with density of 75 kg/m³ and covered in saddle leather.



MARLENPOLTRON

I Sedia in cuoio con braccioli.

E Chair in saddle leather with arms.

F Chaise avec accoudoirs en cuir épais.

D Stuhl in Rindleder mit Armlenhen.

S Silla en cuero con brazos.

CV 1.340,00

CF 1.153,00

CS 919,00

cm. 60 x 54 x h 89 – hs 46
in. 23³/₄ x 21¹/₄ x h 35 – hs 18³/₄



MARLENSEDIA00

I Sedia in cuoio.

E Chair in saddle leather.

F Chaise en cuir épais.

D Stuhl in Rindleder.

S Silla en cuero sin brazos.

CV 937,00

CF 809,00

CS 648,00

cm. 46 x 51 x h 85 – hs 46
in. 18³/₄ x 20³/₄ x h 33¹/₂ – hs 18³/₄

MATERICA - Design Matteo Nunziati



Struttura. Fianchi e schienale in pannello tamburato con bordi e traversi in legno massello di pioppo, cartone a nido d'ape e pannelli nobilitati impiallacciati in essenza. Il basamento, il top e le ante sono in pannello nobilitati impiallacciato. Il piano superiore è disponibile: a) in marmo; b) in pannello nobilitato rivestito in cuoio.

Specchio. Struttura in MDF impiallacciato o rivestito in cuoio o pelle.

Essenze. Disponibile in essenza di noce canaletto fiammato. Altre finiture disponibili su richiesta.

Frame. Side and backrest in honeycomb fiberboard with edges and crossbar in solid poplar wood, honeycomb material and chipboard panel veneered. The base, the top and the front of doors and drawers are in chipboard panel veneered. The top is available in: a) marble; b) melamine coated panel covered in saddle leather.

Mirror. Frame in MDF veneered or covered in saddle leather or leather.

Wood finishes. Available in veined black walnut wood. Other finishes are available on request.



MATERIMADI220

- I Mobile con 2 ante e 2 cassetti in noce canaletto. Top in marmo Emperador Light.
- E Low cabinet with 2 doors and 2 drawers in black walnut. Top in marble Emperador Light.
- F Meuble avec 2 portes et 2 tiroirs en noyer d'Amérique. Top en marbre Emperador Light.
- D Schrank mit 2 Tueren und 2 Schubladen in Amerikanische Nussbaumholz. Marmorplatte Emperador Light.
- S Meuble bajo con 2 puertas y 2 cajones en nogal americano. Encimera en mármol Emperador Light.

9.244,00

cm. 220 x 52 x h 65
in. 86³/₈ x 20¹/₂ x h 25³/₈



MATERISCRI146

- I Scrittoio in noce canaletto. Parte superiore in marmo Emperador Light con 3 contenitori in cuoio.
- E Writing desk in black walnut. Upper part in marble Emperador Light with 3 cases in saddle leather.
- F Bureau en noyer d'Amérique. Partie supérieure en marbre Emperador Light avec 3 récipients en cuir épais.
- D Schreibtisch in Amerikanische Nussbaumholz. Obere Seite in Marmor Emperador Light mit drei Rindleder Container.
- S Escritorio en nogal americano. Parte superior en mármol Emperador Light con 3 contenedores en cuero.

4.718,00

cm. 146 x 65 x h 86
in. 57⁷/₈ x 25³/₈ x h 33³/₈



MATERISPEC200

- I Specchiera con cornice in noce canaletto.
- E Mirror with frame in black walnut.
- F Glace avec cadre en noyer d'Amérique.
- D Spiegel mit Rahmen in Amerikanische Nussbaumholz
- S Espejo con marco en nogal americano.

1.634,00

cm. 80 x 9 x h 200
in. 31¹/₂ x 3³/₈ x h 78³/₈



MATERISPEC200

- I Specchiera con cornice in cuoio o pelle.
- E Mirror with frame in saddle leather or leather.
- F Glace avec cadre en cuir épais ou souple.
- D Spiegel mit Rahmen in Leder oder Rindleder
- S Espejo con marco en cuero o piel.

CV 1.893,00
CF 1.677,00
CS 1.407,00
PA 1.818,00
PX 1.655,00
PF 1.482,00
PS 1.374,00

cm. 80 x 9 x h 200
in. 31¹/₂ x 3³/₈ x h 78³/₈

MATERICA - Design Matteo Nunziati



MATERIPOUF042

- I Pouf.
- E Ottoman.
- F Pouf.
- D Hocker.
- S Pouf.

cm. 42.5 x 42.5 x h 44.5 – hs 44.5 • mt. 1.00
 in. 16³/₄ x 16³/₄ x h 17¹/₂ – hs 17¹/₂ • yd. 1.10

COM	373,00
L	392,00
T	416,00
S	435,00
Z	458,00
K	478,00
PS	576,00
PF	649,00
PX	766,00
PA	877,00

MESH - Design Mauro Lipparini



Piano. E' disponibile in 4 tipologie: a) cristallo temperato extralight; b) marmo Marron Emperador fissato su una lastra d'acciaio; c) pannello nobilitato rivestito in cuoio; d) pannello nobilitato impiallacciato in essenza di Pau Ferro.

Gambe. In acciaio disponibili in 4 finiture: a) rivestite in cuoio; b) verniciate a polveri epossidiche in colore RAL a scelta; c) acciaio inossidabile lucido; d) impiallacciate in essenza di Pau Ferro.

Essenze. Disponibile in essenza di Pau Ferro. Altre finiture disponibili su richiesta.

Top. Is available in 4 different versions: a) extralight tempered glass; b) Marron Emperador marble fixed on steel sheet; c) melamine coated panel covered in saddle leather; d) chipboard panel veneered in Brazilian Ironwood.

Legs. In steel available in 4 different versions: a) covered in saddle leather; b) epoxy powder painted in RAL colors of your choice; c) polished stainless steel; d) veneered in Brazilian Ironwood.

Wood finishes. Available in Brazilian Ironwood. Other finishes are available on request.



MESH00TA200EX

I Piano del tavolo cm. 200x100 in cristallo extrachiario.
E Top of the table cm. 200x100 in extraclear glass.
F Plan de la table cm. 200x100 en verre superclair.
D Platte vom Tisch cm. 200x100 in Durchsichtig Glass.
S Tapa para mesa cm. 200x100 en cristal extraclaro.

cm. 200 x 100 x h 1.5
in. 78" x 39" x h 3/4"

2.744,00



MESH00TA200CU

I Piano del tavolo cm. 200x100 in cuoio.
E Top of the table cm. 200x100 in saddle leather.
F Plan de la table cm. 200x100 en cuir epais.
D Platte vom Tisch cm. 200x100 in Leder bezogen.
S Tapa para mesa cm. 200x100 en cuero.

cm. 200 x 100 x h 3
in. 78" x 39" x h 1 1/4"

CV 2.099,00
CF 1.832,00
CS 1.499,00



MESH00TA200ME

I Piano del tavolo cm. 200x100 in marmo Marron Emperador.
E Top of the table cm. 200x100 in marble Marron Emperador.
F Plan de la table cm. 200x100 en marbre Marron Emperador.
D Platte vom Tisch cm. 200x100 in Marmor Marron Emperador.
S Tapa para mesa cm. 200x100 en mármol Marron Emperador.

cm. 200 x 100 x h 2
in. 78" x 39" x h 3/4"

2.652,00

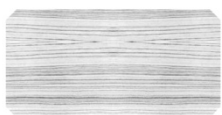

MESH00TA200PA

I Piano del tavolo cm. 200x100 in essenza di Pau Ferro.
E Top of the table cm. 200x100 veneered with Brazilian Ironwood.
F Plan de la table cm. 200x100 en bois Pau Ferro.
D Platte vom Tisch cm. 200x100 in Brasialisches Eisenholz.
S Tapa para mesa cm. 200x100 en esencia de Pau Ferro.

cm. 200 x 100 x h 3
in. 78" x 39" x h 1 1/4"

2.212,00









MESH00TA150EX

I Piano del tavolo Ø cm. 150 in cristallo extrachiario.
E Top of the table Ø cm. 150 in extraclear glass.
F Plan de la table Ø cm. 150 en verre superclair.
D Platte vom Tisch Ø cm. 150 in Durchsichtig Glass.
S Tapa para mesa Ø cm. 150 en cristal extraclaro.

cm. 150 x 150 x h 1.5
in. 59" x 59" x h 3/4"

2.309,00

MESH - Design Mauro Lipparini

	MESH00TA150CU	<p>I Piano del tavolo Ø cm. 150 in cuoio. E Top of the table Ø cm. 150 in saddle leather. F Plan de la table Ø cm. 150 en cuir epais. D Platte vom Tisch Ø cm. 150 in Leder bezogen. S Tapa para mesa Ø cm. 150 en cuero.</p>	<p>CV 2.103,00 CF 1.818,00 CS 1.461,00</p>
	MESH00TA150ME	<p>I Piano del tavolo Ø cm. 150 in marmo Marron Emperador. E Top of the table Ø cm. 150 in marble Marron Emperador. F Plan de la table Ø cm. 150 en marbre Marron Emperador. D Platte vom Tisch Ø cm. 150 in Marmor Marron Emperador. S Tapa para mesa Ø cm. 150 en mármol Marron Emperador.</p>	2.700,00
	MESH00TA150PA	<p>I Piano del tavolo Ø cm. 150 in essenza di Pau Ferro. E Top of the table Ø cm. 150 veneered with Brazilian Ironwood. F Plan de la table Ø cm. 150 en bois Pau Ferro. D Platte vom Tisch Ø cm. 150 in Brasialisches Eisenholz. S Tapa para mesa Ø cm. 150 en esencia de Pau Ferro.</p>	2.141,00
	MESH00GAMBAAC	<p>I Gamba per piano del tavolo in acciaio lucido. E Leg for the top of the table in polished stainless steel. F Pied pour plan de la table en acier inoxydable brillante. D Beine fuer Platte vom Tisch in glaenzend InoxBlech. S Pata para mesa en acero inoxidable brillante.</p>	868,00
	MESH00GAMBACU	<p>I Gamba per piano del tavolo in cuoio. E Leg for the top of the table in saddle leather. F Pied pour plan de la table en cuir epais. D Beine fuer Platte vom Tisch in Rindleder. S Pata para mesa en cuero.</p>	<p>CV 478,00 CF 413,00 CS 333,00</p>
	MESH00GAMBAPA	<p>I Gamba per piano del tavolo impiallacciata in essenza di Pau Ferro. E Leg for the top of the table veneered with Brazilian Ironwood. F Pied pour plan de la table plaquée en bois Pau Ferro. D Beine fuer Platte vom Tisch in Brasilianisches Eisenholz. S Pata para mesa en esencia de Pau Ferro.</p>	793,00
	MESH00GAMBAVE	<p>I Gamba per piano del tavolo verniciata. E Leg for the top of the table varnished. F Pied pour plan de la table verni. D Lackierte Beine fuer Platte vom Tisch. S Pata para mesa barnizada.</p>	324,00

MOORE - Design Umberto Asnago



Tavolo **Piano.** E' disponibile in 3 tipologie: a) cristallo temperato bronzato; b) marmo fissato su una lastra d'acciaio; c) pannello nobilitato impiallacciato in essenza di noce canaletto con finitura "effetto cera".
Gambe. In acciaio disponibili verniciate in colore bianco o nero opaco oppure con particolare finitura spazzolata a mano disponibile in colore: a) bronzo satinato; b) argento satinato; c) rame satinato.

Sedia **Struttura.** In multistrato di pioppo curvato in stampo. L'imbottitura della struttura è ottenuta con una lastra di poliuretano espanso indeformabile con densità 20÷25 kg/m³ esente da CFC.
Gambe. Disponibile in tre versioni: a) in alluminio disponibili verniciate in colore bianco o nero opaco oppure con particolare finitura spazzolata a mano disponibile in colore bronzo satinato, argento satinato oppure rame satinato; b) in massello di noce canaletto con finitura "effetto cera"; c) in legno massello di faggio rivestite in cuoio o pelle; d) basamento girevole a 5 razze su ruote con basculante e pistone a gas.
Rivestimento. Disponibile in tessuto o pelle con profilo sempre in pelle. Non sfoderabile.

Madia. **Struttura.** In pannelli di particelle di legno impiallacciati in essenza tipo bamboo. Parti esterne rivestite in pelle o cuoio. Dettagli in legno massello di noce canaletto con finitura "effetto cera".
Gambe. In acciaio disponibili verniciate in colore bianco o nero opaco oppure con particolare finitura spazzolata a mano disponibile in colore: a) bronzo satinato; b) argento satinato; c) rame satinato.

Table **Top.** Is available in 3 different versions: a) bronzed tempered glass; b) marble fixed on steel sheet; c) chipboard panel veneered in black walnut wood with "wax effect" finish.
Legs. In steel available painted in color white matt or black matt otherwise painted in a special hand-brushed finish available in color: a) satin bronze; b) satin silver; c) satin copper.

Chair **Frame.** In poplar plywood curved into a mould. The framework is upholstered with a contoured sheet of resilient, CFC-free polyurethane foam with density of 20÷25 kg/m³.
Legs. Available in three versions: a) in aluminum available painted in color white matt or black matt otherwise painted in a special hand-brushed finish available in color satin bronze, satin silver or satin copper; b) in black walnut solid heartwood with "wax effect" finish; c) in beech solid heartwood covered in saddle leather or leather; d) swivel 5 star base with casters, tilt and gas-piston mechanism.
Covers. Available in fabric or leather, with piping always in leather. Non removable.

Cabinet. **Frame.** In particleboard veneered in wood bamboo type inside. Outside covered in leather or saddle leather. Details in black walnut solid heartwood with "wax effect" finish.
Legs. In steel available painted in color white matt or black matt otherwise painted in a special hand-brushed finish available in color: a) satin bronze; b) satin silver; c) satin copper.



MOORE0SEIDIA01

I Sedia imbottita con gambe in noce canaletto.
 E Upholstered chair with legs in black walnut.
 F Chaise rembourrée avec pieds en noyer d'Amerique.
 D Gepolstert Stuhl mit Beinen in Amerikanische Nussbaum.
 S Silla rellena con patas en nogal americano.

cm. 53.5 x 60 x h 74.5 – hs 45 • mt. 1.55
 in. 21"½ x 23"¾ x h 29"¾ – hs 17"¾ • yd. 1.70

COM	1.163,00
L	1.190,00
T	1.223,00
S	1.249,00
Z	1.282,00
K	1.310,00
PS	1.423,00
PF	1.524,00
PX	1.687,00
PA	1.839,00



MOORE0SEIDIA02

I Sedia imbottita con gambe in faggio rivestite in pelle o cuoio.
 E Upholstered chair with legs in beech wood covered in leather or saddle leather.
 F Chaise rembourrée avec pieds en hêtre recouverts en cuir souple ou cuir épais.
 D Gepolstert Stuhl mit Beinen in Buche in Leder oder Rindleder bezogen.
 S Silla rellena con patas en haya tapizadas en piel o cuero.

cm. 53.5 x 60 x h 74.5 – hs 45 • mt. 1.55
 in. 21"½ x 23"¾ x h 29"¾ – hs 17"¾ • yd. 1.70

COM	1.034,00
L	1.062,00
T	1.095,00
S	1.122,00
Z	1.155,00
K	1.181,00
PS	1.296,00
PF	1.397,00
PX	1.558,00
PA	1.711,00



MOORE0SEIDIA03

I Sedia imbottita con gambe in faggio laccate bianche o nere.
 E Upholstered chair with legs in beech wood varnished black or white.
 F Chaise rembourrée avec pieds en hêtre laqués blancs ou noirs.
 D Gepolstert Stuhl mit Beinen in Buche schwarzem oder weissem lackiert.
 S Silla rellena con patas en haya pintadas en negro o blanco.

cm. 53.5 x 60 x h 74.5 – hs 45 • mt. 1.55
 in. 21"½ x 23"¾ x h 29"¾ – hs 17"¾ • yd. 1.70

COM	1.182,00
L	1.209,00
T	1.242,00
S	1.269,00
Z	1.302,00
K	1.330,00
PS	1.443,00
PF	1.544,00
PX	1.707,00
PA	1.858,00

MOORE - Design Umberto Asnago



MOORE05EDIA04

I Sedia imbottita con gambe in alluminio rivestite in pelle o cuoio.
 E Upholstered chair with aluminum legs covered in leather or saddle leather.
 F Chaise rembourrée avec pieds en aluminium recouverts en cuir souple ou cuir épais.
 D Gepolstert Stuhl mit Beinen in Aluminium in Leder oder Rindleder bezogen.
 S Silla rellena con patas en aluminio tapizadas en piel o cuero.

cm. 53.5 x 60 x h 74.5 – hs 45 • mt. 1.55
 in. 21” $\frac{1}{8}$ x 23” $\frac{3}{4}$ x h 29” $\frac{3}{8}$ – hs 17” $\frac{3}{4}$ • yd. 1.70

COM	1.327,00
L	1.353,00
T	1.386,00
S	1.414,00
Z	1.446,00
K	1.474,00
PS	1.587,00
PF	1.689,00
PX	1.843,00
PA	2.002,00



MOORE05EDIA05

I Sedia imbottita con gambe in alluminio laccate bianche o nere.
 E Upholstered chair with aluminum legs varnished black or white.
 F Chaise rembourrée avec pieds en aluminium laqués blancs ou noirs.
 D Gepolstert Stuhl mit Aluminium Beinen schwarzem oder weissem lackiert.
 S Silla rellena con patas en aluminio pintadas en negro o blanco.

cm. 53.5 x 60 x h 74.5 – hs 45 • mt. 1.55
 in. 21” $\frac{1}{8}$ x 23” $\frac{3}{4}$ x h 29” $\frac{3}{8}$ – hs 17” $\frac{3}{4}$ • yd. 1.70

COM	1.404,00
L	1.432,00
T	1.465,00
S	1.491,00
Z	1.524,00
K	1.551,00
PS	1.666,00
PF	1.766,00
PX	1.928,00
PA	2.081,00

MOORE05ESUVER

I Supplemento per gambe verniciate in colore bronzo satinato.
 E Extra charge for legs varnished in satin bronze colour.
 F Supplément pour pieds laqués en couleur bronze satinée.
 D Mehrpreis fuer lackierten Beinen Farbe satiniert Bronze.
 S Suplemento para patas pintadas en color de bronce satinado.

402,00



MOORE05POLTUFF

I Poltrona girevole, con basculante, regolabile in altezza mediante gas. Basamento in alluminio spazzolato.
 E Armchair with swivel, tilt and gas-lift mechanism. Base with brushed aluminium.
 F Fauteuil pivotant avec bascule, réglable en hauteur par système gaz. Piètement en aluminium brossé.
 D Sessel mit Wippmechanik, höhenverstellbar durch Gasfeder-pneumatik. Gestell in abgebürstet Aluminium.
 S Sillon giratorio con basculant, regulable en altura con pistón de gas. Base en aluminio cepillado.

cm. 53.5 x 60 x h 83/92 – hs 50/59 • mt. 1.55
 in. 21” $\frac{1}{8}$ x 23” $\frac{3}{4}$ x h 32” $\frac{3}{8}$ /36” $\frac{1}{4}$ – hs 19” $\frac{3}{8}$ /23” $\frac{1}{4}$ • yd. 1.70

COM	971,00
L	1.000,00
T	1.036,00
S	1.065,00
Z	1.100,00
K	1.130,00
PS	1.244,00
PF	1.353,00
PX	1.528,00
PA	1.692,00

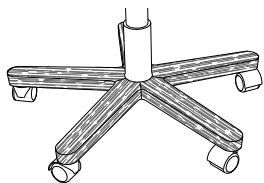

OPTIONUFFBASE

I Supplemento per rivestimento in massello di noce canaletto del basamento a 5 razze in alluminio su ruote di qualsiasi poltrona per ufficio.
 E Extra charge for covering in solid black walnut wood of the 5 star aluminum base on casters for every kind of office chair.
 F Supplément pour recouvrir en noyer d’Amérique massif le pied 5 branches en aluminium sur roulettes de n’importe quel fauteuil de bureau.
 D Realisierung Mehrpreis fuer Bekleidung von festen Walnussrahmen der Basis 5 – Speichen – Aluminiumraeder von jedem Buerosessel.
 S Suplemento para el revestimiento de madera de nogal americano de la base de 5 radios en aluminio con ruedas para cualquier sillón de oficina.

376,00

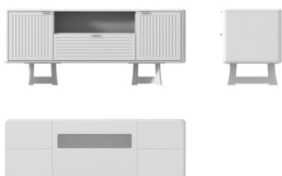

MOORE0MOBI168

I Mobile con struttura in legno tipo bamboo. Top e fianchi rivestiti in pelle con dettagli in noce canaletto; 2 ante e cassetto centrale rivestiti in pelle con disegno 3D e cornice in noce canaletto. Base in acciaio verniciata nera o bianca.
 E Cabinet with frame in wood like bamboo. Top an side panels covered in leather with inlays in black walnut wood; 2 doors and central drawer covered in leather with 3D pattern and edges in black walnut wood. Steel base varnished in black or white.
 F Meuble avec structure en bois comme bambou. Top et côtés en cuir souple et détails en noyer d’Amérique; 2 portes et tiroir central recouverts en cuir souple avec un motif 3D et cadre en noyer d’Amérique. Piètement an acier laqué blanc ou noir.
 D Schrank mit Gestell in Holz wie Bambus. Platte und Seiten in Leder bezogen mit Einzelheit in Amerikanische Nussbaum; 2 Tueren und 1 zentral Schublade in Leder bezogen mit 3D Zeichnung und Rahmen in Americanische Nussbaum. Gestell in Stahl schwarz oder weiss lackiert.
 S Meuble bajo con estructura en madera como el bambú. Encimera y lados en piel con detalle en nogal americano; 2 puertas y cajone central tapizados en piel con diseño 3D y marco en nogal americano. Base en acero pintada en negro o blanco.

cm. 165.5 x 55 x h 70.5
 in. 65” $\frac{1}{2}$ x 21” $\frac{1}{2}$ x h 27” $\frac{3}{4}$

PA	6.739,00
PX	6.593,00
PF	6.438,00
PS	6.340,00

MOORE - Design Umberto Asnago



MOORE0MOBI235

I Mobile con struttura in legno tipo bamboo. Top e fianchi rivestiti in pelle con dettagli in noce canaletto; 4 ante e cassetto centrale rivestiti in pelle con disegno 3D e cornice in noce canaletto. Base in acciaio verniciata nera o bianca.
E Cabinet with frame in wood like bamboo. Top and side panels covered in leather with inlays in black walnut wood; 4 doors and central drawer covered in leather with 3D pattern and edges in black walnut wood. Steel base varnished in black or white.
F Meuble avec structure en bois comme bambou. Top et côtés en cuir souple et détails en noyer d'Amérique; 4 portes et tiroir central recouverts en cuir souple avec un motif 3D et cadre en noyer d'Amérique. Piètement an acier laqué blanc ou noir.
D Schrank mit Gestell in Holz wie Bambus. Platte und Seiten in Leder bezogen mit Einzelheit in Amerikanische Nussbaum; 4 Tueren und 1 zentral Schublade in Leder bezogen mit 3D Zeichnung und Rahmen in Americanische Nussbaum. Gestell in Stahl schwarz oder weiss lackiert.
S Meuble bajo con estructura en madera como el bambú. Encimera y lados en piel con detalle en nogal americano; 4 puertas y cajone central tapizados en piel con diseño 3D y marco en nogal americano. Base en acero pintada en negro o blanco.

PA 8.658,00
 PX 8.375,00
 PF 8.072,00
 PS 7.870,00

cm. 235.5 x 55 x h 70.5
 in. 92³/₄ x 21³/₄ x h 27³/₄

MOORE0MOSUVER

I Supplemento per base del mobile verniciata in colore bronzo satinato.
E Extra charge for cabinet base varnished in satin bronze colour.
F Supplément pour piètement de le mauble laqué en couleur bronze satiné.
D Mehrpreis fuer lackierten Gestell der Schrank Farbe satiniert Bronze.
S Suplemento para base del meuble pintada en color de bronce satinado.

311,00

MOORE0MOSUVAS

I Supplemento per vassoio in pelle per vano a giorno.
E Extra charge for tray in leather for open unit.
F Supplément pour plateau en cuir souple pour compartiment ouvert.
D Mehrpreis fuer Tablett fuer Regal.
S Suplemento para bandeja en piel para compartimento abierto

564,00

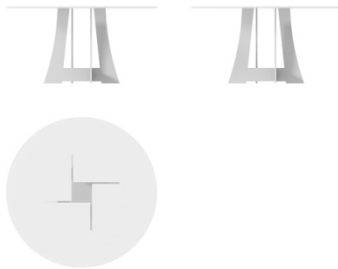

MOORE0TA140CR

I Tavolo Ø cm. 140 in cristallo bronzato e temperato. Base in acciaio verniciata nera o bianca.
E Table Ø cm. 140 in bronzed and tempered glass. Steel base varnished in black or white.
F Table Ø cm. 140 en cristal bronzé et trempé. Piètement an acier laqué blanc ou noir.
D Tisch Ø cm. 140 in gehärttem bronzefarbe Glas. Stahl Gestell schwarzem oder weissem lackiert
S Mesa Ø cm. 140 en cristal templado y bronceado. Base en acero pintada en negro o blanco.

5.450,00

cm. 140 x 140 x h 72.5
 in. 55³/₄ x 55³/₄ x h 28³/₄

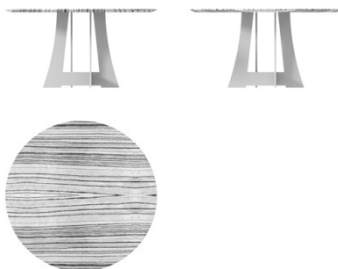

MOORE0TA140ES

I Tavolo Ø cm. 140 in noce canaletto. Base in acciaio verniciata nera o bianca.
E Table Ø cm. 140 in black walnut wood. Steel base varnished in black or white.
F Table Ø cm. 140 en noyer d'Amérique. Piètement an acier laqué blanc ou noir.
D Tisch Ø cm. 140 in Amerikanische Nussbaum. Stahl Gestell schwarzem oder weissem lackiert
S Mesa Ø cm. 140 en nogal americano. Base en acero pintada en negro o blanco.

4.122,00

cm. 140 x 140 x h 73
 in. 55³/₄ x 55³/₄ x h 28³/₄



MOORE0TA140MC / MOORE0TA140MM

I Tavolo Ø cm. 140 in marmo calacatta oro (codice **MOORE0TA140MC**) o nero marquina, marron emperador o bianco carrara gioia (codice **MOORE0TA140MM**). Base in acciaio verniciata nera o bianca.
E Table Ø cm. 140 in Calacatta Oro Marble (code **MOORE0TA140MC**) or in black Marquina, Marron Emperador or White Carrara Gioia marble (code **MOORE0TA140MM**). Steel base varnished in black or white.
F Table Ø cm. 140 en marbre Calacatta Oro (code **MOORE0TA140MC**) ou en marbre noir Marquina, Marron Emperador ou blanc Carrara Gioia (code **MOORE0TA140MM**). Piètement an acier laqué blanc ou noir.
D Tisch Ø cm. 140 in Calacatta Oro Marmor (Code **MOORE0TA140MC**) oder in Marmor Marquina schwarz, Marmor Marron Emperador oder weissen Marmor Carrara Gioia (Code **MOORE0TA140MM**). Stahl Gestell schwarzem oder weissem lackiert
S Mesa Ø cm. 140 en mármol Calacatta oro (código **MOORE0TA140MC**) o en mármol Marquina negro, Marron Emperador o bien blanco Carrara Gioia (código **MOORE0TA140MM**). Base en acero pintada en negro o blanco.

MC 5.683,00
 MM 5.124,00

cm. 140 x 140 x h 74
 in. 55³/₄ x 55³/₄ x h 29³/₄

MOORE - Design Umberto Asnago

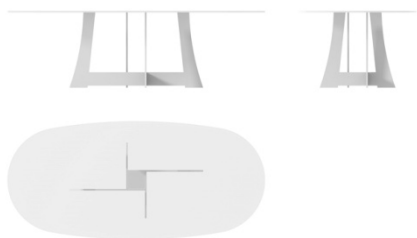

MOORE0TA240CR

I Tavolo ovale cm. 240x110 in cristallo bronzato e temperato. Base in acciaio verniciata nera o bianca.
 E Oval table cm. 240x110 in bronzed and tempered glass. Steel base varnished in black or white.
 F Table ovale cm. 240x110 en cristal bronzé et trempé. Piétement an acier laqué blanc ou noir.
 D Oval Tisch cm. 240x110 in gehärtetem bronzefarbe Glas. Stahl Gestell schwarzem oder weissem lackiert
 S Mesa oval cm. 240x110 en cristal templado y bronceado. Base en acero pintada en negro o blanco.

6.082,00

cm. 240 x 110 x h 72.5
 in. 94"½ x 43"¼ x h 28"½

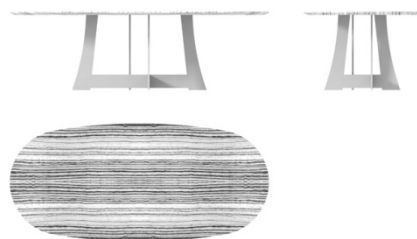

MOORE0TA240ES

I Tavolo ovale cm. 240x110 in noce canaletto. Base in acciaio verniciata nera o bianca.
 E Oval table cm. 240x110 in black walnut wood. Steel base varnished in black or white.
 F Table ovale cm. 240x110 en noyer d'Amérique. Piétement an acier laqué blanc ou noir.
 D Oval Tisch cm. 240x110 in Amerikanische Nussbaum. Stahl Gestell schwarzem oder weissem lackiert
 S Mesa oval cm. 240x110 en nogal americano. Base en acero pintada en negro o blanco.

5.010,00

cm. 240 x 110 x h 73
 in. 94"½ x 43"¼ x h 28"½



MOORE0TA240MC / MOORE0TA240MM

I Tavolo ovale cm. 240x110 in marmo calacatta oro (codice **MOORE0TA240MC**) o nero marquina, marron emperador o bianco carrara gioia (codice **MOORE0TA240MM**). Base in acciaio verniciata nera o bianca.
 E Oval table cm. 240x110 in Calacatta Oro Marble (code **MOORE0TA240MC**) or in black Marquina, Marron Emperador or White Carrara Gioia marble (code **MOORE0TA240MM**). Steel base varnished in black or white.
 F Table ovale cm. 240x110 en marbre Calacatta Oro (code **MOORE0TA240MC**) ou en marbre noir Marquina, Marron Emperador ou blanc Carrara Gioia (code **MOORE0TA240MM**). Piétement an acier laqué blanc ou noir.
 D Oval Tisch cm. 240x110 in Calacatta Oro Marmor (Code **MOORE0TA240MC**) oder in Marmor Marquina schwarz, Marmor Marron Emperador oder weissen Marmor Carrara Gioia (Code **MOORE0TA240MM**). Stahl Gestell schwarzem oder weissem lackiert
 S Mesa oval cm. 240x110 en mármol Calacatta oro (código **MOORE0TA240MC**) o en mármol Marquina negro, Marron Emperador o bien blanco Carrara Gioia (código **MOORE0TA240MM**). Base en acero pintada en negro o blanco.

MC 7.114,00

MM 6.282,00

cm. 240 x 110 x h 74
 in. 94"½ x 43"¼ x h 29"½

MOORE0TASUVER

I Supplemento per base del tavolo verniciata in colore bronzo satinato.
 E Extra charge for table base varnished in satin bronze colour.
 F Supplément pour piétement de la table laqué en couleur bronze satiné.
 D Mehrpreis fuer lackierten Gestell der Tisch Farbe satiniert Bronze.
 S Suplemento para base de la mesa pintada en color de bronzo satinado.

779,00

NANCY - Design Umberto Asnago



Struttura. In tubolare d'acciaio disponibile in finitura cromata o verniciata a polveri epossidiche in colore RAL a scelta.

Rivestimento. Disponibile in cuoio; non sfoderabile.

Frame. In tubular steel available chromed or epoxy powder painted in RAL colors of your choice.

Covers. Available in saddle leather; non removable covers.

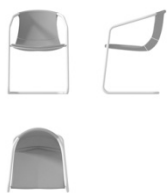

NANCYOSEDIA01

I Sedia in cuoio con basamento in tubolare d'acciaio cromato nero o verniciato in colore RAL.

E Saddle leather chair with tubular base in steel black chromed or painted in RAL color.

F Chaise en cuir épais avec avec piètement en acier tubulaire chromé noir ou verni en couleur RAL.

D Stuhl in Rindleder mit röhrenförmigen Stahl Fuss schwarz verchromtem oder in RAL-Farbe lackiert.

S Silla de cuero con base tubular en acero cromado negro o pintado en color RAL.

CV 2.509,00

CF 2.336,00

CS 2.120,00

cm. 58 x 60 x h 80 – hs 45
in. 22³/₄ x 23³/₄ x h 31¹/₂ – hs 17³/₄

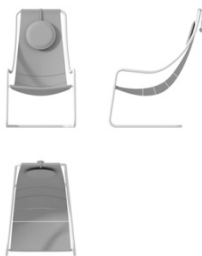

NANCYOPOLTR02

I Poltroncina a schienale alto in cuoio con basamento in tubolare d'acciaio cromato nero o verniciato in colore RAL.

E Saddle leather high back small armchair with tubular base in steel black chromed or painted in RAL color.

F Fauteuil à dossier haut en cuir épais avec avec piètement en acier tubulaire chromé noir ou verni en couleur RAL.

D Sessel mit hoher Rückenlehne in Rindleder mit röhrenförmigen Stahl Fuss schwarz verchromtem oder in RAL-Farbe lackiert.

S Sillón con respaldo alto de cuero con base tubular en acero cromado negro o pintado en color RAL.

CV 3.604,00

CF 3.344,00

CS 3.020,00

cm. 66 x 88 x h 110 – hs 35
in. 26¹/₂ x 34³/₄ x h 43³/₄ – hs 13³/₄

NAPA - Design Umberto Asnago



Piano. In pannello nobilitato rivestito in cuoio o pelle con inserto in cristallo acidato retro verniciato in tinta con il colore di cuoio o pelle scelto.
Gambe. In tubolare d'acciaio cromato.

Top. In melamine coated panel covered in saddle leather or leather with inlay in acid-etched glass painted in the same color of the saddle leather or leather chosen.
Legs. In chromed tubular steel.

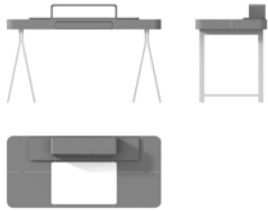

NAPA00SCRIT01

I Scrittoio rivestito in cuoio o pelle con inserto in cristallo acidato; supporti in acciaio cromato nero.
E Writing desk covered in saddle leather or leather with inlay in frosted glass; feet in steel black chromed.
F Bureau recouvert en cuir épais ou cuir souple, avec insertion en cristal acidé; supports en acier chromé noir.
D Schreibtisch in Rindleder oder Leder gepolstert mit Beilage in Glas geätzt; schwarz verchromtem Fuss.
S Escritorio tapizado en cuero o piel, con inserto en vidrio grabado; base cromada negra.

cm. 140 x 65 x h 75/88.5
 in. 55¹/₂ x 25¹/₂ x h 29¹/₂/34¹/₂

CV	4.589,00
CF	4.329,00
CS	4.005,00
PA	4.498,00
PX	4.303,00
PF	4.095,00
PS	3.966,00

NIKY - Design Daniele Lo Scalzo Moscheri



Struttura. Struttura interna in pannello nobilitato con finitura lino; struttura esterna in pannello truciolare impiallacciato in essenza tipo eucalipto. Ante e frontali dei cassetti disponibili in tre finiture: a) essenza tipo eucalipto; b) rivestiti in cuoio o pelle; c) laccati con una particolare finitura spazzolata a mano disponibile in colore bronzo satinato, argento satinato o rame satinato.

Base. Piedini in tubolare d'acciaio verniciato a polveri epossidiche in colore nero. Le estremità sono in acciaio con finitura galvanica dorata.

Essenze. Disponibile in essenza tipo eucalipto. Altre finiture disponibili su richiesta.

Frame. Inside frame in melamine coated panel with linen finish; outside frame in chipboard panel veneered in eucalyptus type wood. Doors and front of drawers available in three finishes: a) eucalyptus type wood; b) covered in saddle leather or leather; c) lacquered in a special hand-brushed finish available in color: a) satin bronze; b) satin silver; c) satin copper.

Base. Supports in tubular steel epoxy powder black painted with terminal support in steel with golden galvanic finishing.

Wood finishes. Available in eucalyptus type wood. Other finishes are available on request.

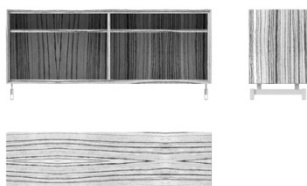

NIKY00MOBI190

I Struttura per mobile basso in finitura melaminico lino; top e fianchi in legno tipo eucalipto. Predisposto per 4 ante e 2 cassetti.

E Frame for low cabinet in melamine linen finish ; top and sides in wood like eucalyptus. Suitable for 4 doors and 2 drawers.

F Structure pour meuble bas en melaminé finissage lin; top et côtés en bois comme eucalyptus. Disponible avec 4 portes et 2 tiroirs.

D Gestell fuer niedrige Schrank in Leineneffekt Melaminbeschichtet; Platte und Seiten in Eukalyptus Holz. Vorbereitet fuer 4 Tueren und 2 Schubladen.

S Meuble bajo con estructura en melamina acabada lino; encimera y lados en madera como el eucalipto. Preparado para 4 puertas y 2 cajones.

cm. 189.7 x 54 x h 83.8
in. 74 7/8 x 21 1/4 x h 33"

3.893,00

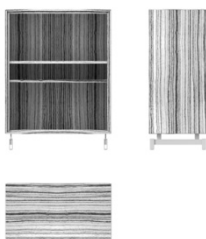

NIKY00MOBI095

I Struttura per mobile intermedio in finitura melaminico lino; top e fianchi in legno tipo eucalipto. Predisposto per 2 ante, 1 cassetto e 1 anta a ribalta.

E Frame for medium cabinet in melamine linen finish ; top and sides in wood like eucalyptus. Suitable for 2 doors, 1 drawer and 1 flap door.

F Structure pour meuble moyen en melaminé finissage lin; top et côtés en bois comme eucalyptus. Disponible avec 2 portes, 1 tiroir et 1 porte à abattant.

D Gestell fuer Mittelhohe Schrank in Leineneffekt Melaminbeschichtet; Platte und Seiten in Eukalyptus Holz. Vorbereitet fuer 2 Tueren, 1 Schublade und 1 Klapptuer.

S Meuble intermedio con estructura en melamina acabada lino; encimera y lados en madera como el eucalipto. Preparado para 2 puertas, 1 cajon y 1 puerta abatible.

cm. 97.8 x 54 x h 130.3
in. 38 1/2 x 21 1/4 x h 51 1/4"

3.784,00



NIKY00MOBANES

I Anta per mobile in eucalipto.

E Door for cabinet in eucalyptus.

F Porte pour meuble en eucalyptus.

D Tuer fuer Schrank in Eukalyptus Holz.

S Puerta para meuble en eucalipto.

cm. 45 x h 44.5
in. 17 3/4 x h 17 1/2"

411,00



NIKY00MOBANCU

I Anta per mobile in pelle o cuoio.

E Door for cabinet in leather or saddle leather.

F Porte pour meuble en cuir souple ou cuir épais.

D Tuer fuer Schrank in Leder oder Rindleder.

S Puerta para meuble en piel o cuero.

cm. 45 x h 44.5
in. 17 3/4 x h 17 1/2"

CV 407,00

CF 376,00







CS 339,00

PA 396,00

PX 373,00

PF 349,00

PS 334,00

	<p>NIKY00MOBANLA</p> <p>I Anta per mobile laccate in colore bronzo satinato. E Door for cabinet varnished in satin bronze colour. F Porte pour meuble laquées en couleur bronze satiné. D Lackierten Tuer in Farbe satiniert Bronze fuer Schrank. S Puerta para meuble pintada en color de bronze satinado.</p>	<p>535,00</p>
<p>cm. 45 x h 44,5 in. 17³/₄ x h 17¹/₂</p>		
	<p>NIKY00MOBCAES</p> <p>I Cassetto ante per mobile in eucalipto. E Drawer for cabinet in eucalyptus. F Tiroir pour meuble en eucalyptus. D Schublade fuer Schrank in Eukalyptus Holz. S Cajón para meuble en eucalipto.</p>	<p>662,00</p>
<p>cm. 90.5 x h 17 in. 35³/₄ x h 6³/₄</p>		
	<p>NIKY00MOBCACU</p> <p>I Cassetto per mobile in pelle o cuoio. E Drawer for cabinet in leather or saddle leather. F Tiroir pour meuble en cuir souple ou cuir épais. D Schublade fuer Schrank in Leder oder Rindleder. S Cajón para meuble en piel o cuero.</p>	<p>CV 610,00 CF 583,00 CS 551,00 PA 600,00 PX 581,00 PF 560,00 PS 547,00</p>
<p>cm. 90.5 x h 17 in. 35³/₄ x h 6³/₄</p>		
	<p>NIKY00MOBCALA</p> <p>I Cassetto per mobile laccato in colore bronzo satinato. E Drawe for cabinet varnished in satin bronze colour. F Tiroir pour meuble laqué en couleur bronze satiné. D Lackierten Schublade in Farbe satiniert Bronze fuer Schrank. S Cajón para meuble pintado en color de bronze satinado.</p>	<p>786,00</p>
<p>cm. 90.5 x h 17 in. 35³/₄ x h 6³/₄</p>		
	<p>NIKY00MOBARES</p> <p>I Anta a ribalta per mobile in eucalipto. E Flap door for cabinet in eucalyptus. F Porte à abattant pour meuble en eucalyptus. D Klapptuer fuer Schrank in Eukalyptus Holz. S Puerta abatible para meuble en eucalipto.</p>	<p>986,00</p>
<p>cm. 90.5 x h 46 in. 35³/₄ x h 18³/₄</p>		
	<p>NIKY00MOBARCU</p> <p>I Anta a ribalta per mobile in pelle o cuoio. E Flap door for cabinet in leather or saddle leather. F Porte à abattant pour meuble en cuir souple ou cuir épais. D Klapptuer fuer Schrank in Leder oder Rindleder. S Puerta abatible para meuble en piel o cuero.</p>	<p>CV 975,00 CF 915,00 CS 838,00 PA 954,00 PX 908,00 PF 860,00 PS 830,00</p>
<p>cm. 90.5 x h 46 in. 35³/₄ x h 18³/₄</p>		
	<p>NIKY00MOBARLA</p> <p>I Anta a ribalta per mobile laccata in colore bronzo satinato. E Flap door for cabinet varnished in satin bronze colour. F Porte à abattant pour meuble laquée en couleur bronze satiné. D Lackierten Klapptuer in Farbe satiniert Bronze fuer Schrank. S Puerta abatible para meuble pintada en color de bronze satinado.</p>	<p>1.234,00</p>
<p>cm. 90.5 x h 46 in. 35³/₄ x h 18³/₄</p>		

PAPIER - Design Matteo Nunziati



Tavolo **Piano.** E' disponibile in 2 tipologie: a) marmo; b) pannello truciolare impiallacciato in essenza di tipo rovere naturale, rovere moro o rovere titanio.
Base. In multistrato di faggio curvato in stampo e rivestito in cuoio. Basamento in acciaio verniciato nero opaco.

Sedia **Struttura.** Schienale e sedile in tubolare d'acciaio; il molleggio è garantito da cinghie elastiche in polipropilene e lattice naturale fissate alla struttura in acciaio. La struttura è annegata in poliuretano espanso con densità di 55 kg/m³, schiumato a freddo in stampo. La schiuma poliuretana soddisfa la classe 1 IM di resistenza al fuoco secondo la legge italiana ed è disponibile anche secondo altri standard internazionali.
Gambe. In acciaio rivestito con lastre di poliuretano e rivestite in tessuto o pelle.
Rivestimento. Disponibile in tessuto o pelle. Non sfoderabile.

Madia. **Struttura.** In pannelli nobilitati con finitura rovere bianco. Top, fianchi e ante rivestiti in cuoio.
Gambe. In pannelli nobilitati con finitura rovere bianco e rivestiti in cuoio.

Table **Top.** Is available in 2 different versions: a) marble; b) chipboard panel veneered in natural oak type wood, dark brown oak type wood or titanium oak type wood.
Base. In beech plywood curved into a mould and covered in saddle leather. Base in black matt steel painted.

Chair **Frame.** The frame of the backrest and seat is in tubular steel; the webbing is secured by elastic polypropylene and natural latex belts fixed to the metal frame. The frame is embedded in cold formed polyurethane foam made in mould with density of 55 kg/m³. The foam complies with the Italian Classe 1IM fire resistant law and is available on request for other international standards.
Legs. In steel covered by sheets of polyurethane foam and covered by fabric or leather.
Covers. Available in fabric or leather. Non removable.

Cabinet. **Frame.** In melamine coated panel with white oak finish. Top, sides and doors covered in saddle leather.
Legs. In melamine coated panel with white oak finish. Top, sides and doors covered in saddle leather.



PAPIERSEDIA01

I Sedia imbottita con profilo verniciato nero.
 E Dining upholstered chair with black varnished profile.
 F Chaise rembourrée avec profile verni noire.
 D Gepolstert Stuhl mit Profil schwarz lackiert.
 S Silla rellena con perfil barnizado negro.

cm. 48 x 57 x h 86 – hs 46 • mt. 1.10
 in. 18”½ x 22”½ x h 33”½ – hs 18”½ • yd. 1.20

COM	902,00
L	924,00
T	950,00
S	971,00
Z	998,00
K	1.020,00
PS	1.126,00
PF	1.203,00
PX	1.328,00
PA	1.445,00



PAPIERSEDIA02

I Sedia imbottita.
 E Dining upholstered chair.
 F Chaise rembourrée.
 D Gepolstert Stuhl.
 S Silla rellena.

cm. 48 x 57 x h 86 – hs 46 • mt. 1.10
 in. 18”½ x 22”½ x h 33”½ – hs 18”½ • yd. 1.20

COM	617,00
L	639,00
T	664,00
S	686,00
Z	712,00
K	733,00
PS	840,00
PF	918,00
PX	1.042,00
PA	1.159,00



PAPIERMADI230

I Mobile con 4 ante rivestito in cuoio.
 E Low cabinet with 4 doors covered in saddle leather.
 F Meuble avec 4 portes recouvert en cuir épais.
 D Schrank mit 4 Tueren in Rindleder bezogen.
 S Meuble bajo con 4 puertas tapizado en cuero.

cm. 230.5 x 46.5 x h 67.5
 in. 90”¾ x 18”¼ x h 26”½

CV	4.214,00
CF	3.741,00
CS	3.151,00

PAPIER - Design Matteo Nunziati

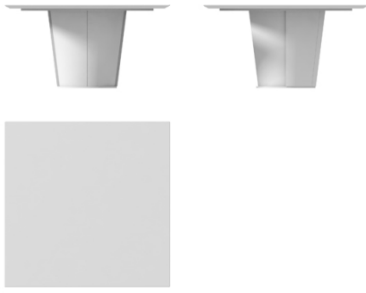

PAPIERT150QCU

I Tavolo cm. 150X150 con piano e base rivestiti in cuoio.
 E Table cm. 150X150 with top and base in saddle leather.
 F Table cm. 150X150 avec plan et pietément en cuir épais.
 D Tisch cm. 150X150 mit Platte und Gestell in Rindleder bezogen.
 S Mesa cm. 150X150 con tapa y base en cuero.

CV 4.438,00
 CF 3.848,00
 CS 3.111,00

cm. 150 x 150 x h 75,5
 in. 59" x 59" x h 29"¾

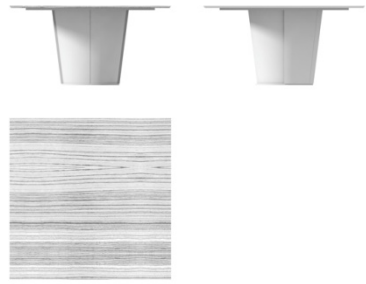

PAPIERT150QES

I Tavolo cm. 150X150 con piano in essenza di rovere moro o naturale e base rivestita in cuoio.
 E Table cm. 150X150 with top in dark brown or natural oak and base in saddle leather.
 F Table cm. 150X150 avec plan en placage de rouvre foncé ou naturel et pietément en cuir épais.
 D Tisch cm. 150X150 mit Platte in dunkel oder Natureichen und Gestell in Rindleder bezogen.
 S Mesa cm. 150X150 con tapa en madera de roble negro o natural y base en cuero.

CV 4.536,00
 CF 4.310,00
 CS 4.025,00

cm. 150 x 150 x h 75,5
 in. 59" x 59" x h 29"¾



PAPIERT150QMA

I Tavolo cm. 150X150 con piano in marmo calacatta oro e base rivestita in cuoio.
 E Table cm. 150X150 with top in calacatta oro marble and base in saddle leather.
 F Table cm. 150X150 avec plan en marbre calacatta oro et pietément en cuir épais.
 D Tisch cm. 150X150 mit Platte in Calacatta Oro Marmor un Gestell in Rindleder bezogen.
 S Mesa cm. 150X150 con tapa en mármol Calacatta oro y base en cuero.

CV 6.475,00
 CF 6.247,00
 CS 6.032,00

cm. 150 x 150 x h 74
 in. 59" x 59" x h 29"¾

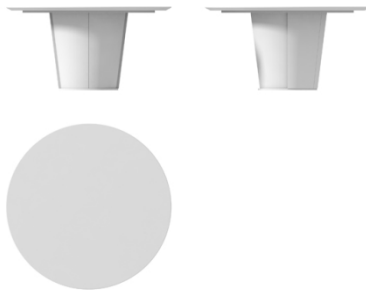

PAPIERT150TCU

I Tavolo Ø cm. 150 con piano e base rivestiti in cuoio.
 E Table Ø cm. 150 with top and base in saddle leather.
 F Table Ø cm. 150 avec plan et pietément en cuir épais.
 D Tisch Ø cm. 150 mit Platte und Gestell in Rindleder bezogen.
 S Mesa Ø cm. 150 con tapa y base en cuero.

CV 4.438,00
 CF 3.848,00
 CS 3.111,00

cm. 150 x 150 x h 75,5
 in. 59" x 59" x h 29"¾



PAPIERT150TES

I Tavolo Ø cm. 150 con piano in essenza di rovere moro o naturale e base rivestita in cuoio.
 E Table Ø cm. 150 with top in dark brown or natural oak and base in saddle leather.
 F Table Ø cm. 150 avec plan en placage de rouvre foncé ou naturel et pietément en cuir épais.
 D Tisch Ø cm. 150 mit Platte in dunkel oder Natureichen und Gestell in Rindleder bezogen.
 S Mesa Ø cm. 150 con tapa en madera de roble negro o natural y base en cuero.

CV 4.536,00
 CF 4.310,00
 CS 4.025,00

cm. 150 x 150 x h 75,5
 in. 59" x 59" x h 29"¾

PAPIER - Design Matteo Nunziati



PAPIERT150TMA

I Tavolo Ø cm. 150 con piano in marmo calacatta oro e base rivestita in cuoio.
 E Table Ø cm. 150 with top in calacatta oro marble and base in saddle leather.
 F Table Ø cm. 150 avec plan en marbre calacatta oro et pietément en cuir épais.
 D Tisch Ø cm. 150 mit Platte in Calacatta Oro Marmor un Gestell in Rindleder bezogen.
 S Mesa Ø cm. 150 con tapa en mármol Calacatta oro y base en cuero.

CV 6.179,00
 CF 5.952,00
 CS 5.668,00

cm. 150 x 150 x h 74
 in. 59" x 59" x h 29"¾



PAPIERTA300CU

I Tavolo cm. 300x130 con piano e base rivestiti in cuoio.
 E Table cm. 300x130 with top and base in saddle leather.
 F Table cm. 300x130 avec plan et pietément en cuir épais.
 D Tisch cm. 300x130 mit Platte und Gestell in Rindleder bezogen.
 S Mesa cm. 300x130 con tapa y base en cuero.

CV 8.344,00
 CF 7.217,00
 CS 5.809,00

cm. 300 x 130 x h 75.5
 in. 118"¾ x 51"¾ x h 29"¾

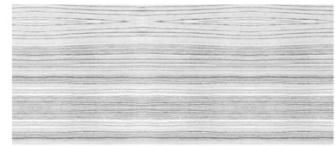

PAPIERTA300ES

I Tavolo cm. 300x130 con piano in essenza di rovere moro o naturale e base rivestita in cuoio.
 E Table cm. 300x130 with top in dark brown or natural oak and base in saddle leather.
 F Table cm. 300x130 avec plan en placage de rouvre foncé ou naturel et pietément en cuir épais.
 D Tisch cm. 300x130 mit Platte in dunkel oder Natureichen und Gestell in Rindleder bezogen.
 S Mesa cm. 300x130 con tapa en madera de roble negro o natural y base en cuero.

CV 7.978,00
 CF 7.524,00
 CS 6.957,00

cm. 300 x 130 x h 75.5
 in. 118"¾ x 51"¾ x h 29"¾



PAPIERTA300MA

I Tavolo cm. 300x130 con piano in marmo calacatta oro e base rivestita in cuoio.
 E Table cm. 300x130 with top in calacatta oro marble and base in saddle leather.
 F Table cm. 300x130 avec plan en marbre calacatta oro et pietément en cuir épais.
 D Tisch cm. 300x130 mit Platte in Calacatta Oro Marmor un Gestell in Rindleder bezogen.
 S Mesa cm. 300x130 con tapa en mármol Calacatta oro y base en cuero.

CV 12.087,00
 CF 11.633,00
 CS 11.065,00

cm. 300 x 130 x h 74
 in. 118"¾ x 51"¾ x h 29"¾

SERA - Design Luca Scacchetti



Piano. E' costituito da un sottopiano su cui poggia il piano vero e proprio. Il sottopiano è in pannello nobilitato con bordo rivestito in cuoio; il piano è in pannello truciolare impiallacciato in essenza di tipo ebano.

Gambe. In legno massello pioppo impiallacciate in essenza di tipo ebano.

Mobili. Struttura in pannelli di truciolare impiallacciati in essenza di tipo ebano con alcune parti rivestite in cuoio.

Top. Is composed by a sub top on which is fixed the real top. The sub top is in melamine coated panel with the edges covered in saddle leather; the top is chipboard panel veneered in ebony type wood.

Legs. In solid poplar wood veneered in ebony type wood.

Cabinets. Frame in clipboard panels veneered in ebony type wood with some parts covered in saddle leather.

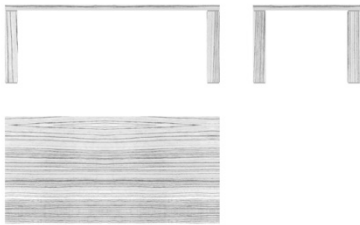

SERA00TA200ES

I Tavolo cm. 200x110 in essenza di noce, zebrano o tipo ebano e profili in pelle o cuoio.

E Table cm. 200x110 in walnut wood, zebran wood or similar ebony wood and edges in leather or saddle leather.

F Table cm. 200x110 en placage de noyer, zebrano ou comme ébène et chants en cuir souple ou épais.

D Tisch cm. 200x110 in Nussbaum, Zebranzholz oder Ebenholz und Kanten in Leder oder Rindleder bezogen.

S Mesa cm. 200x110 en madera de nogal, zebrano o ébano y bordes en piel o cuero.

CV 5.913,00

CF 5.878,00

CS 5.835,00

cm. 200 x 110 x h 73
in. 78³/₄ x 43³/₄ x h 28³/₄

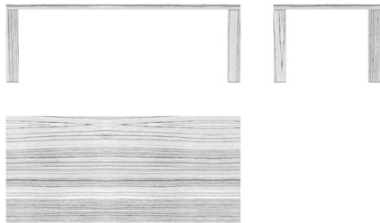

SERA00TA218ES

I Tavolo cm. 218x110 in essenza di noce, zebrano o tipo ebano e profili in pelle o cuoio.

E Table cm. 218x110 in walnut wood, zebran wood or similar ebony wood and edges in leather or saddle leather.

F Table cm. 218x110 en placage de noyer, zebrano ou comme ébène et chants en cuir souple ou épais.

D Tisch cm. 218x110 in Nussbaum, Zebranzholz oder Ebenholz und Kanten in Leder oder Rindleder bezogen.

S Mesa cm. 218x110 en madera de nogal, zebrano o ébano y bordes en piel o cuero.

CV 6.181,00

CF 6.142,00

CS 6.093,00

cm. 218 x 110 x h 73
in. 85³/₄ x 43³/₄ x h 28³/₄

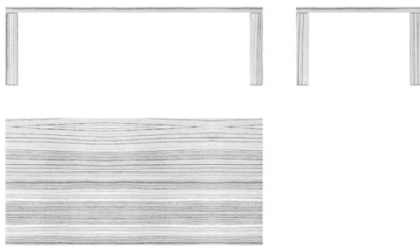

SERA00TA240ES

I Tavolo cm. 240x110 in essenza di noce, zebrano o tipo ebano e profili in pelle o cuoio.

E Table cm. 240x110 in walnut wood, zebran wood or similar ebony wood and edges in leather or saddle leather.

F Table cm. 240x110 en placage de noyer, zebrano ou comme ébène et chants en cuir souple ou épais.

D Tisch cm. 240x110 in Nussbaum, Zebranzholz oder Ebenholz und Kanten in Leder oder Rindleder bezogen.

S Mesa cm. 240x110 en madera de nogal, zebrano o ébano y bordes en piel o cuero.

CV 6.485,00

CF 6.442,00

CS 6.388,00

cm. 240 x 110 x h 73
in. 94³/₄ x 43³/₄ x h 28³/₄



SERA00TA318ES

I Tavolo cm. 318x118 in essenza di noce, zebrano o tipo ebano e profili in pelle o cuoio.

E Table cm. 318x118 in walnut wood, zebran wood or similar ebony wood and edges in leather or saddle leather.

F Table cm. 318x118 en placage de noyer, zebrano ou comme ébène et chants en cuir souple ou épais.

D Tisch cm. 318x118 in Nussbaum, Zebranzholz oder Ebenholz und Kanten in Leder oder Rindleder bezogen.

S Mesa cm. 318x118 en madera de nogal, zebrano o ébano y bordes en piel o cuero.

CV 7.657,00

CF 7.604,00

CS 7.539,00

cm. 318 x 118 x h 73
in. 125³/₄ x 46³/₄ x h 28³/₄

SERA - Design Luca Scacchetti

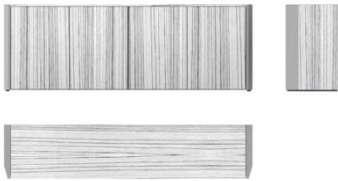

SERA00MADIAES

I Mobile con 4 ante in essenza di noce, zebrano o tipo ebano e profili in pelle o cuoio.
 E Low cabinet with 4 doors in walnut wood, zebran wood or similar ebony wood and edges in leather or saddle leather.
 F Meuble avec 4 portes en placage de noyer, zebrano ou comme ébène et chants en cuir souple ou épais.
 D Schrank mit 4 Tueren in Nussbaum, Zebranzholz oder Ebenholz und Kanten in Leder oder Rindleder bezogen.
 S Meuble bajo con 4 puertas en madera de nogal, zebrano o ébano y bordes en piel o cuero.

CV 5.825,00
 CF 5.794,00
 CS 5.757,00

cm. 232 x 50 x h 79
 in. 91¹/₂ x 19¹/₂ x h 31¹/₂

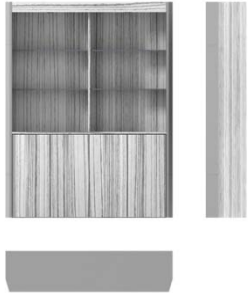

SERA00MOBIBAR

I Mobile bar con 4 ante in essenza di noce, zebrano o tipo ebano e profili in pelle o cuoio. Ripiani in cristallo.
 E Low cabinet with 4 doors in walnut wood, zebran wood or similar ebony wood and edges in leather or saddle leather. Shelves in transparent glass.
 F Meuble avec 4 portes en placage de noyer, zebrano ou comme ébène et chants en cuir souple ou épais. Etagères en verre.
 D Schrank mit 4 Tueren in Nussbaum, Zebranzholz oder Ebenholz und Kanten in Leder oder Rindleder bezogen. Glass Regale.
 S Meuble bajo con 4 puertas en madera de nogal, zebrano o ébano y bordes en piel o cuero. Estantes de vidrio.

CV 8.451,00
 CF 8.062,00
 CS 7.575,00

cm. 156 x 38 x h 200
 in. 61¹/₂ x 15" x h 78¹/₂



SERA00BANCBAR

I Bancone bar con fronte e fianchi in lati noce, zebrano o ebano e bordi in cuoio o pelle; zoccolo in acciaio. Piano di lavoro in noce, zebrano o ebano, piano al pubblico in cristallo extrachiaro temperato.
 E Bar counter with front and sides in walnut, zebran or ebony wood and edges in leather or saddle leather; baseboard in stainless steel. Worktop in walnut, zebran or ebony wood, public top in extraclear tempered glass.
 F Comptoir bar avec partie frontale et cotés en noyer, zebrano ou ébène avec bordure en cuir souple ou épais; socle en acier inoxydable. Plan de travail en noyer, zebrano ou ébène, plan pour visiteurs en cristal extra clair trempé.
 D Bartheke mit Fronten und Seiten in Nussbaum, Zebranzholz oder Ebenholz und Kanten in Leder oder Rindleder, Sockel in Edelstahl. Arbeitplatte in Nussbaum, Zebranzholz oder Ebenholz. Empfangplatte in gehaertet durchsichtig Glas.
 S Contador de la barra con el frente y laterales en madera de nogal, zebrano o ébano y cantos en piel o cuero; zócalo en acero inoxidable. Encimera en madera de nogal, zebrano o ébano, tapa al público en cristal templado extra-claro.

CV 7.962,00
 CF 7.707,00
 CS 7.389,00

cm. 180 x 66 x h 104
 in. 70¹/₂ x 26" x h 41"

SHU - Design Alessandro Dubini



Struttura. In tubolare d'acciaio. L'imbottitura della struttura è ottenuta con una lastra di poliuretano espanso indeformabile ed esente da CFC.

Base. Disponibile in due varianti: a) in massello di noce canaletto con finitura a "effetto cera"; b) in acciaio cromato o verniciato a polveri epossidiche in colore RAL a scelta.

Rivestimento. Disponibile in cuoio; non sfoderabile.

Frame. In tubular steel. The framework is upholstered with a contoured sheet of resilient, CFC-free polyurethane foam.

Base. Available in two versions: a) in solid black walnut heartwood with "wax effect" finishing; b) in steel available chromed or epoxy powder painted in RAL colors of your choice.

Covers. Available in saddle leather; non removable covers.



SHU000SEDIACU

I Sedia in noce canaletto e cuoio.

E Chair in black walnut wood and saddle leather

F Chaise en noyer d'Amérique et cuir épais

D Stuhl mit Amerikanische Nussbaum und Rindleder.

S Silla en nogal americano y cuero.

CV 1.588,00

CF 1.433,00

CS 1.223,00

cm. 51 x 60 x h 84 – hs 48
in. 20¹/₂ x 23³/₄ x h 33¹/₂ – hs 18¹/₂



SHU000SEDIACRO

I Sedia in cuoio con base cromata.

E Chair in saddle leather with chromed base.

F Chaise en cuir épais et piètement chromé.

D Stuhl in Rindleder mit verchromtem Gestell.

S Silla en cuero con base cromada.

CV 1.774,00

CF 1.618,00

CS 1.423,00

cm. 51 x 60 x h 84 – hs 48
in. 20¹/₂ x 23³/₄ x h 33¹/₂ – hs 18¹/₂

SHU000SUPCRNE

I Supplemento per basamento cromato nero.

E Extra charge for black chromed base.

F Supplément pour piètement chromé noir.

D Mehrpreis fuer schwarz verchromtem Gestell.

S Suplemento para la base cromada negra.

113,00

SHU000SUPLACC

I Supplemento per basamento laccato RAL.

E Extra charge for lacquered base in RAL colour.

F Supplément pour piètement laqué en couleur RAL.

D Mehrpreis fuer Gestell RAL Farbe lackiert.

S Suplemento para la base pintada en color RAL.

91,00

SILHOUETTE - Design Luca Scacchetti



Struttura. In multistrato di faggio curvato in stampo. L'imbottitura della struttura è ottenuta con poliuretano espanso indeformabile esente da CFC schiumato a freddo in stampo. La parte esterna è disponibile imbottita o impiallacciata in essenza di latì o tipo ebano.

Cuscino. In poliuretano espanso indeformabile ed esente da CFC.

Base. In tubolare d'acciaio cromato.

Rivestimento. Disponibile in tessuto e pelle; non sfoderabile.

Frame. In beech plywood curved into a mould. The framework is upholstered with CFC-free polyurethane foam cold formed into a mould. The outside frame is available upholstered or veneered in latì wood or ebony type wood.

Cushion. In resilient CFC-free polyurethane foam.

Base. In chromed tubular steel.

Covers. Available in fabric or leather; non removable covers.



SILHOUOLT031

I Sedia per visitatori con basamento in tubolare d'acciaio cromato.

E Visitor's chair with tubular chromed steel base.

F Chaise pour visiteurs avec piétement en acier tubulaire chromé.

D Besucherstuhl Stahlrohrgestell verchromt.

S Silla confidente con base en tubular de acero cromado.

cm. 57 x 57 x h 85 – hs 49 • mt. 2.40
in. 22¹/₂ x 22¹/₂ x h 33¹/₂ – hs 19¹/₄ • yd. 2.65

COM	1.906,00
L	1.952,00
T	2.007,00
S	2.054,00
Z	2.109,00
K	2.155,00
PS	2.519,00
PF	2.687,00
PX	2.956,00
PA	3.208,00

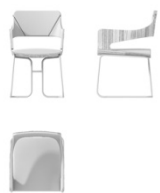

SILHOUOLT032

I Sedia per visitatori con parte esterna dello schienale e dei braccioli in latì o ebano, con basamento in tubolare d'acciaio cromato.

E Visitor's chair with outside of the back and the armpads in latì wood or ebonywood, with tubular chromed steel base.

F Chaise pour visiteurs avec partie extérieure du dossier et des accoudoirs en latì ou ébène avec piétement en acier tubulaire chromé.

D Besucherstuhl mit aussen Teil von der Rückenlehne und Armlehnen in Latì Holz oder in Ebenholz Stahlrohrgestell verchromt.

S Silla confidente con la parte externa del respaldo y de los brazos acabada en latì o bien en ébano con base en tubular de acero cromado.

cm. 57 x 57 x h 85 – hs 49 • mt. 1.45
in. 22¹/₂ x 22¹/₂ x h 33¹/₂ – hs 19¹/₄ • yd. 1.60

COM	2.281,00
L	2.309,00
T	2.342,00
S	2.369,00
Z	2.402,00
K	2.429,00
PS	2.662,00
PF	2.759,00
PX	2.913,00
PA	3.058,00

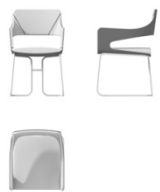

SILHOUOLT033

I Sedia per visitatori con parte esterna dello schienale e dei braccioli laccata in colore bianco, nero o in RAL 1019, con basamento in tubolare d'acciaio cromato.

E Tub armchair with outside of the back and the armpads lacquered in colour white, black or RAL 1019, with tubular chromed steel base.

F Chaise pour visiteurs avec partie extérieure du dossier et des accoudoirs lacquée en couleur blanche, noire ou RAL 1019, avec piétement en acier tubulaire chromé.

D Besucherstuhl mit aussen Teil von der Rückenlehne und Armlehnen in lackiert in weiss, schwarz oder RAL 1019 Farbe Stahlrohrgestell verchromt.

S Silla confidente con la parte externa del respaldo y de los brazos pintada blanca, negra y RAL 1019 con base en tubular de acero cromado.

cm. 57 x 57 x h 85 – hs 49 • mt. 1.45
in. 22¹/₂ x 22¹/₂ x h 33¹/₂ – hs 19¹/₄ • yd. 1.60

COM	2.175,00
L	2.203,00
T	2.235,00
S	2.263,00
Z	2.296,00
K	2.323,00
PS	2.556,00
PF	2.653,00
PX	2.807,00
PA	2.952,00



SILHOUOLT034

I Sgabello bar con basamento tondo in acciaio cromato.

E Barstool with round base in chromed steel.

F Tabouret pour bar avec piétement rond en acier chromée.

D Barstuhl mit rundem Gestell Stahl verchromt.

S Taburete con base cromada con plato redondo

cm. 57 x 57 x h 100/126 – hs 62/88 • mt. 2.40
in. 22¹/₂ x 22¹/₂ x h 39³/₄/49³/₄ – hs 24³/₄/34³/₄ • yd. 2.65

COM	1.924,00
L	1.970,00
T	2.025,00
S	2.071,00
Z	2.127,00
K	2.173,00
PS	2.537,00
PF	2.705,00
PX	2.974,00
PA	3.226,00

SILHOUETTE - Design Luca Scacchetti



SILHOUPOLT035

I Sgabello bar con parte esterna dello schienale e dei braccioli in lati o ebano, con basamento tondo in acciaio cromato.
E Barstool with outside of the back and the armpads in lati wood or ebonywood, with round base in chromed steel.
F Tabouret pour bar avec partie extérieure du dossier et des accoudoirs en lati ou ébène avec piétement rond en acier chromée.
D Barstuhl mit aussen Teil von der Rückenlehne und Armlehnen in Lati Holz oder in Ebenholz mit rundem Gestell Stahl verchromt.
S Taburete con la parte externa del respaldo y de los brazos acabada en lati o bien en ébano con base cromada con plato redondo.

cm. 57 x 57 x h 100/126 – hs 62/88 • mt. 1.45
 in. 22¹/₂ x 22¹/₂ x h 39³/₄/49³/₄ – hs 24³/₄/34³/₄ • yd. 1.60

COM	2.298,00
L	2.326,00
T	2.358,00
S	2.386,00
Z	2.418,00
K	2.446,00
PS	2.679,00
PF	2.775,00
PX	2.930,00
PA	3.075,00



SILHOUPOLT036

I Sgabello bar con parte esterna dello schienale e dei braccioli laccata in colore bianco, nero o in RAL 1019, con basamento tondo in acciaio cromato
E Barstool armchair with outside of the back and the armpads lacquered in colour white, black or RAL 1019, with round base in chromed steel.
F tabouret pour bar avec partie extérieure du dossier et des accoudoirs lacquée en couleur blanche, noire ou RAL 1019, avec piétement rond en acier chromée.
D Barstuhl mit aussen Teil von der Rückenlehne und Armlehnen in lackiert in weiss, schwarz oder RAL 1019 Farbe mit rundem Gestell Stahl verchromt.
S Taburete con la parte externa del respaldo y de los brazos pintada blanca, negra y RAL 1019 con base cromada con plato redondo.

cm. 57 x 57 x h 100/126 – hs 62/88 • mt. 1.45
 in. 22¹/₂ x 22¹/₂ x h 39³/₄/49³/₄ – hs 24³/₄/34³/₄ • yd. 1.60

COM	2.192,00
L	2.220,00
T	2.252,00
S	2.280,00
Z	2.312,00
K	2.340,00
PS	2.573,00
PF	2.669,00
PX	2.824,00
PA	2.969,00

SISSI - Design Luca Scacchetti



Struttura. Schienale e sedile in tubolare d'acciaio; il molleggio è garantito da cinghie elastiche in polipropilene e lattice naturale fissate alla struttura in acciaio. La struttura è annegata in poliuretano espanso con densità di 55 kg/m³, schiumato a freddo in stampo. La schiuma poliuretanica soddisfa la classe 1 IM di resistenza al fuoco secondo la legge italiana ed è disponibile anche secondo altri standard internazionali.

Gambe. In acciaio verniciato a polveri epossidiche in colore RAL a scelta.

Rivestimento. Disponibile in tessuto o pelle. Non sfoderabile.

Frame. The frame of the backrest and seat is in tubular steel; the webbing is secured by elastic polypropylene and natural latex belts fixed to the metal frame. The frame is embedded in cold formed polyurethane foam made in mould with density of 55 kg/m³. The foam complies with the Italian Classe 1IM fire resistant law and is available on request for other international standards.

Legs. In steel epoxy powder painted in RAL colors of your choice.

Covers. Available in fabric or leather. Non removable.



SISSI0POLTPOZ

- I Poltroncina a pozzetto.
- E Tub armchair.
- F Chaise.
- D Stuhl.
- S Silla.

cm. 55 x 57 x h 75 – hs 47 • mt. 1.90
in. 21³/₈ x 22¹/₂ x h 19¹/₂ – hs 18¹/₂ • yd. 2.05

COM	1.002,00
L	1.039,00
T	1.084,00
S	1.120,00
Z	1.164,00
K	1.201,00
PS	1.310,00
PF	1.418,00
PX	1.591,00
PA	1.754,00



SISSI0POLTBRA

- I Poltroncinacon braccioli.
- E Armchair.
- F Chaise.
- D Stuhl.
- S Silla.

cm. 55 x 57 x h 75 – hs 47 • mt. 1.65
in. 21³/₈ x 22¹/₂ x h 19¹/₂ – hs 18¹/₂ • yd. 1.80

COM	986,00
L	1.019,00
T	1.058,00
S	1.090,00
Z	1.129,00
K	1.161,00
PS	1.277,00
PF	1.377,00
PX	1.536,00
PA	1.685,00

SLICK - Design Mauro Lipparini



Struttura. In pannello nobilitato rivestito in cuoio.

Base. In tubolare d'acciaio cromata o verniciata a polveri epossidiche in colore RAL a scelta.

Frame. In melamine coated panel covered in saddle leather.

Base. In tubular steel chromed or painted epoxy powder painted in RAL colors of your choice.



SLICK0MOAL240

I Struttura per mobile h. 43 cm. lunghezza 240 cm. rivestito in cuoio con 4 cassetti.
 E Frame for cabinet h. 43 cm. length 240 cm. covered in saddle leather with 4 drawers.
 F Structure pour meuble h. 43 cm. Longueur 240 cm. revetu en cuir avec 4 tiroirs.
 D Gestell 4 Schubladen fuer Schrank h. 43 cm. Laenge 240 cm. Mit Leder bezogen.
 S Estructura para mueble alto cm. 43 largo cm. 240 tapizado en cuero con 4 cajones.

CV 5.664,00
 CF 5.019,00
 CS 4.213,00

cm. 240 x 70.5 x h 43
 in. 94"½ x 27"¾ x h 16"¾



SLICK0MOAL160

I Struttura per mobile h. 43 cm. lunghezza 160 cm. rivestito in cuoio con 4 cassetti.
 E Frame for cabinet h. 43 cm. length 160 cm. covered in saddle leather with 4 drawers.
 F Structure pour meuble h. 43 cm. Longueur 160 cm. revetu en cuir avec 4 tiroirs.
 D Gestell 4 Schubladen fuer Schrank h. 43 cm. Laenge 160 cm. Mit Leder bezogen.
 S Estructura para mueble alto cm. 43 largo cm. 160 tapizado en cuero con 4 cajones.

CV 4.447,00
 CF 3.992,00
 CS 3.425,00

cm. 160 x 70.5 x h 43
 in. 63" x 27"¾ x h 16"¾



SLICK0MOBA240

I Struttura per mobile h. 23 cm. lunghezza 240 cm. rivestito in cuoio con 3 cassetti.
 E Frame for cabinet h. 23 cm. length 240 cm. covered in saddle leather with 3 drawers.
 F Structure pour meuble h. 23 cm. Longueur 240 cm. revetu en cuir avec 3 tiroirs.
 D Gestell 4 Schubladen fuer Schrank h. 23 cm. Laenge 240 cm. Mit Leder bezogen.
 S Estructura para mueble alto cm. 23 largo cm. 240 tapizado en cuero con 3 cajones.

CV 3.890,00
 CF 3.472,00
 CS 2.950,00

cm. 240 x 70.5 x h 23
 in. 94"½ x 27"¾ x h 9"



SLICK0MOBA160

I Struttura per mobile h. 23 cm. lunghezza 160 cm. rivestito in cuoio con 2 cassetti.
 E Frame for cabinet h. 23 cm. length 160 cm. covered in saddle leather with 2 drawers.
 F Structure pour meuble h. 23 cm. Longueur 160 cm. revetu en cuir avec 2 tiroirs.
 D Gestell 4 Schubladen fuer Schrank h. 23 cm. Laenge 160 cm. Mit Leder bezogen.
 S Estructura para mueble alto cm. 23 largo cm. 160 tapizado en cuero con 2 cajones.

CV 2.733,00
 CF 2.461,00
 CS 2.120,00

cm. 160 x 70.5 x h 23
 in. 63" x 27"¾ x h 9"



SLICK0MOBA080

I Struttura per mobile h. 23 cm. lunghezza 82 cm. rivestito in cuoio con 1 cassetto.
 E Frame for cabinet h. 23 cm. length 82 cm. covered in saddle leather with 1 drawer.
 F Structure pour meuble h. 23 cm. Longueur 82 cm. revetu en cuir avec 1 tiroir.
 D Gestell 4 Schubladen fuer Schrank h. 23 cm. Laenge 82 cm. Mit Leder bezogen.
 S Estructura para mueble alto cm. 23 largo cm. 82 tapizado en cuero con 1 cajón.

CV 1.604,00
 CF 1.422,00
 CS 1.195,00

cm. 82 x 70.5 x h 23
 in. 32"¾ x 27"¾ x h 9"

	<p>I Basamento alto in tubolare metallico tondo cm. 240. Finitura verniciata (V) o cromata (C). E High feet in round tubular steel cm. 240. Finishing varnished (V) or chromed (C). F Base haute en métal tubolaire rond cm. 240 vernie (V) ou chromée (C). D Runde-roehrenfoermig-hoher Metall-Sockel cm. 240. Lackiert (V) oder Verchromt (C). S Base alta en tubo de acero redondo cm. 240. Acabado pintado (V) o cromado (C).</p>	<p>SLICK0BAA240V 886,00</p>	<p>SLICK0BAA240C 1.050,00</p>
<p>cm. 240 x 70.5 x h 22 in. 94"½ x 27"¾ x h 8"¾</p>			
	<p>I Basamento alto in tubolare metallico tondo cm. 160. Finitura verniciata (V) o cromata (C). E High feet in round tubular steel cm. 160. Finishing varnished (V) or chromed (C). F Base haute en métal tubolaire rond cm. 160 vernie (V) ou chromée (C). D Runde-roehrenfoermig-hoher Metall-Sockel cm. 160. Lackiert (V) oder Verchromt (C). S Base alta en tubo de acero redondo cm. 160. Acabado pintado (V) o cromado (C).</p>	<p>SLICK0BAA160V 795,00</p>	<p>SLICK0BAA160C 972,00</p>
<p>cm. 160 x 70.5 x h 22 in. 63" x 27"¾ x h 8"¾</p>			
	<p>I Basamento basso in tubolare metallico tondo cm. 240. Finitura verniciata (V) o cromata (C). E Low feet in round tubular steel cm. 240. Finishing varnished (V) or chromed (C). F Base basse en métal tubolaire rond cm. 240 vernie (V) ou chromée (C). D Runde-roehrenfoermig-nidriger Metall-Sockel cm. 240. Lackiert (V) oder Verchromt (C). S Base baja con tubo de acero redondo cm. 240. Acabado pintado (V) o cromado (C).</p>	<p>SLICK0BBT240V 645,00</p>	<p>SLICK0BBT240C 840,00</p>
<p>cm. 240 x 70.5 x h 3 in. 94"½ x 27"¾ x h 1"¼</p>			
	<p>I Basamento basso in tubolare metallico tondo cm. 160. Finitura verniciata (V) o cromata (C). E Low feet in round tubular steel cm. 160. Finishing varnished (V) or chromed (C). F Base basse en métal tubolaire rond cm. 160 vernie (V) ou chromée (C). D Runde-roehrenfoermig-nidriger Metall-Sockel cm. 160. Lackiert (V) oder Verchromt (C). S Base baja con tubo de acero redondo cm. 160. Acabado pintado (V) o cromado (C).</p>	<p>SLICK0BBT160V 536,00</p>	<p>SLICK0BBT160C 677,00</p>
<p>cm. 160 x 70.5 x h 3 in. 63" x 27"¾ x h 1"¼</p>			
	<p>I Basamento basso in tubolare metallico quadrato cm. 240. Finitura verniciata (V) o cromata (C). E Low feet in square tubular steel cm. 240. Finishing varnished (V) or chromed (C). F Base basse en métal tubolaire carré cm. 240 vernie (V) ou chromée (C). D Viereckig-roehrenfoermig-nidriger Metall-Sockel cm. 240. Lackiert (V) oder Verchromt (C). S Base baja en tubo de acero cuadrado cm. 240. Acabado pintado (V) o cromado (C).</p>	<p>SLICK0BBQ240V 441,00</p>	<p>SLICK0BBQ240C 735,00</p>
<p>cm. 240 x 70.5 x h 3 in. 94"½ x 27"¾ x h 1"¼</p>			
	<p>I Basamento basso in tubolare metallico quadrato cm. 160. Finitura verniciata (V) o cromata (C). E Low feet in square tubular steel cm. 160. Finishing varnished (V) or chromed (C). F Base basse en métal tubolaire carré cm. 160 vernie (V) ou chromée (C). D Viereckig-roehrenfoermig-nidriger Metall-Sockel cm. 160. Lackiert (V) oder Verchromt (C). S Base baja en tubo de acero cuadrado cm. 160. Acabado pintado (V) o cromado (C).</p>	<p>SLICK0BBQ160V 268,00</p>	<p>SLICK0BBQ160C 554,00</p>
<p>cm. 160 x 70.5 x h 3 in. 63" x 27"¾ x h 1"¼</p>			
	<p>SLICK0MSAL240 I Struttura per mobile h. 43 cm. lunghezza 240 cm. rivestito in cuoio con 4 cassetti. E Frame for cabinet h. 43 cm. length 240 cm. covered in saddle leather with 4 drawers. F Structure pour meuble h. 43 cm. Longueur 240 cm. revetu en cuir avec 4 tiroirs. D Gestell 4 Schubladen fuer Schrank h. 43 cm. Laenge 240 cm. Mit Leder bezogen. S Estructura para mueble alto cm. 43 largo cm. 240 tapizado en cuero con 4 cajones.</p>	<p>CV 4.853,00 CF 4.279,00 CS 3.559,00</p>	
<p>cm. 240 x 56 x h 43 in. 94"½ x 22" x h 16"¾</p>			



SLICKOMSAL160

I Struttura per mobile h. 43 cm. lunghezza 160 cm. rivestito in cuoio con 4 cassetti.
 E Frame for cabinet h. 43 cm. length 160 cm. covered in saddle leather with 4 drawers.
 F Structure pour meuble h. 43 cm. Longueur 160 cm. revetu en cuir avec 4 tiroirs.
 D Gestell 4 Schubladen fuer Schrank h. 43 cm. Laenge 160 cm. Mit Leder bezogen.
 S Estructura para mueble alto cm. 43 largo cm. 160 tapizado en cuero con 4 cajones.

CV 3.953,00
 CF 3.550,00
 CS 3.048,00

cm. 160 x 56 x h 43
 in. 63" x 22" x h 16"½



SLICKOMSBA240

I Struttura per mobile h. 23 cm. lunghezza 240 cm. rivestito in cuoio con 3 cassetti.
 E Frame for cabinet h. 23 cm. length 240 cm. covered in saddle leather with 3 drawers.
 F Structure pour meuble h. 23 cm. Longueur 240 cm. revetu en cuir avec 3 tiroirs.
 D Gestell 4 Schubladen fuer Schrank h. 23 cm. Laenge 240 cm. Mit Leder bezogen.
 S Estructura para mueble alto cm. 23 largo cm. 240 tapizado en cuero con 3 cajones.

CV 3.299,00
 CF 2.937,00
 CS 2.482,00

cm. 240 x 56 x h 23
 in. 94"½ x 22" x h 9"



SLICKOMSBA160

I Struttura per mobile h. 23 cm. lunghezza 160 cm. rivestito in cuoio con 2 cassetti.
 E Frame for cabinet h. 23 cm. length 160 cm. covered in saddle leather with 2 drawers.
 F Structure pour meuble h. 23 cm. Longueur 160 cm. revetu en cuir avec 2 tiroirs.
 D Gestell 4 Schubladen fuer Schrank h. 23 cm. Laenge 160 cm. Mit Leder bezogen.
 S Estructura para mueble alto cm. 23 largo cm. 160 tapizado en cuero con 2 cajones.

CV 2.479,00
 CF 2.245,00
 CS 1.953,00

cm. 160 x 56 x h 23
 in. 63" x 22" x h 9"



SLICKOMSBA080

I Struttura per mobile h. 23 cm. lunghezza 82 cm. rivestito in cuoio con 1 cassetto.
 E Frame for cabinet h. 23 cm. length 82 cm. covered in saddle leather with 1 drawer.
 F Structure pour meuble h. 23 cm. Longueur 82 cm. revetu en cuir avec 1 tiroir.
 D Gestell 4 Schubladen fuer Schrank h. 23 cm. Laenge 82 cm. Mit Leder bezogen.
 S Estructura para mueble alto cm. 23 largo cm. 82 tapizado en cuero con 1 cajón.

CV 1.378,00
 CF 1.232,00
 CS 1.048,00

cm. 82 x 56 x h 23
 in. 32"¼ x 22" x h 9"

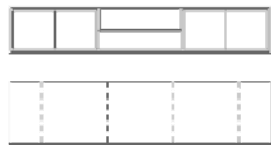

SLICKOMSGG240

I Struttura per mobile h. 43 cm. lunghezza 240 cm. rivestito in cuoio con 4 ante e 1 cassetto.
 E Frame for cabinet h. 43 cm. length 240 cm. covered in saddle leather with 4 doors and 1 drawer.
 F Structure pour meuble h. 43 cm. Longueur 240 cm. revetu en cuir avec 4 portes et 1 tiroirs.
 D Gestell 4 Tueren und 1 Schublade fuer Schrank h. 43 cm. Laenge 240 cm. Mit Leder bezogen.
 S Estructura para mueble alto cm. 43 largo cm. 240 tapizado en cuero con 4 puertas y 1 cajone.

CV 4.842,00
 CF 4.207,00
 CS 3.411,00

cm. 240 x 56 x h 43
 in. 94"½ x 22" x h 16"½

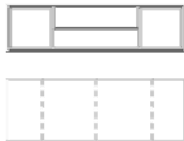

SLICKOMSGG160

I Struttura per mobile h. 43 cm. lunghezza 160 cm. rivestito in cuoio con 2 ante e 1 cassetto.
 E Frame for cabinet h. 43 cm. length 160 cm. covered in saddle leather with 2 doors and 1 drawer.
 F Structure pour meuble h. 43 cm. Longueur 160 cm. revetu en cuir avec 2 portes et 1 tiroir.
 D Gestell 2 Tueren und 1 Schublade fuer Schrank h. 43 cm. Laenge 160 cm. Mit Leder bezogen.
 S Estructura para mueble alto cm. 43 largo cm. 160 tapizado en cuero con 2 puertas y 1 cajone.

CV 3.900,00
 CF 3.445,00
 CS 2.877,00

cm. 160 x 56 x h 43
 in. 63" x 22" x h 16"½



I Basamento alto in tubolare metallico tondo cm. 240. Finitura verniciata (V) o cromata (C).
 E High feet in round tubular steel cm. 240. Finishing varnished (V) or chromed (C).
 F Base haute en métal tubolaire rond cm. 240 vernie (V) ou chromée (C).
 D Runde-roehrenfoermig-hoher Metall-Sockel cm. 240. Lackiert (V) oder Verchromt (C).
 S Base alta en tubo de acero redondo cm. 240. Acabado pintado (V) o cromado (C).

SLICKOBSA240V
 818,00

SLICKOBSA240C
 990,00

cm. 240 x 56 x h 22
 in. 94"½ x 22" x h 8"½

SLICK - Design Mauro Lipparini

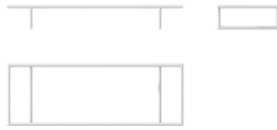

I Basamento alto in tubolare metallico tondo cm. 160. Finitura verniciata (V) o cromata (C).
E High feet in round tubular steel cm. 160. Finishing varnished (V) or chromed (C).
F Base haute en métal tubolaire rond cm. 160 vernie (V) ou chromée (C).
D Runde-roehrenfoermig-hoher Metall-Sockel cm. 160. Lackiert (V) oder Verchromt (C).
S Base alta en tubo de acero redondo cm. 160. Acabado pintado (V) o cromado (C).

SLICK0BSA160V
709,00

SLICK0BSA160C
927,00

cm. 160 x 56 x h 22
 in. 63" x 22" x h 8⁵/₈"



I Basamento basso in tubolare metallico tondo cm. 240. Finitura verniciata (V) o cromata (C).
E Low feet in round tubular steel cm. 240. Finishing varnished (V) or chromed (C).
F Base basse en métal tubolaire rond cm. 240 vernie (V) ou chromée (C).
D Runde-roehrenfoermig-nidriger Metall-Sockel cm. 240. Lackiert (V) oder Verchromt (C).
S Base baja con tubo de acero redondo cm. 240. Acabado pintado (V) o cromado (C).

SLICK0BST240V
545,00

SLICK0BST240C
713,00

cm. 240 x 56 x h 3
 in. 94¹/₂" x 22" x h 1¹/₄"



I Basamento basso in tubolare metallico tondo cm. 160. Finitura verniciata (V) o cromata (C).
E Low feet in round tubular steel cm. 160. Finishing varnished (V) or chromed (C).
F Base basse en métal tubolaire rond cm. 160 vernie (V) ou chromée (C).
D Runde-roehrenfoermig-nidriger Metall-Sockel cm. 160. Lackiert (V) oder Verchromt (C).
S Base baja con tubo de acero redondo cm. 160. Acabado pintado (V) o cromado (C).

SLICK0BST160V
490,00

SLICK0BST160C
641,00

cm. 160 x 56 x h 3
 in. 63" x 22" x h 1¹/₄"



I Basamento basso in tubolare metallico quadrato cm. 240. Finitura verniciata (V) o cromata (C).
E Low feet in square tubular steel cm. 240. Finishing varnished (V) or chromed (C).
F Base basse en métal tubolaire carré cm. 240 vernie (V) ou chromée (C).
D Viereckig-roehrenfoermig-nidriger Metall-Sockel cm. 240. Lackiert (V) oder Verchromt (C).
S Base baja en tubo de acero cuadrado cm. 240. Acabado pintado (V) o cromado (C).

SLICK0BSQ240V
431,00

SLICK0BSQ240C
699,00

cm. 240 x 56 x h 3
 in. 94¹/₂" x 22" x h 1¹/₄"



I Basamento basso in tubolare metallico quadrato cm. 160. Finitura verniciata (V) o cromata (C).
E Low feet in square tubular steel cm. 160. Finishing varnished (V) or chromed (C).
F Base basse en métal tubolaire carré cm. 160 vernie (V) ou chromée (C).
D Viereckig-roehrenfoermig-nidriger Metall-Sockel cm. 160. Lackiert (V) oder Verchromt (C).
S Base baja en tubo de acero cuadrado cm. 160. Acabado pintado (V) o cromado (C).

SLICK0BSQ160V
254,00

SLICK0BSQ160C
622,00

cm. 160 x 56 x h 3
 in. 63" x 22" x h 1¹/₄"

TUCROMA - Design Guido Faleschini



Struttura. In tubolare d'acciaio cromato o verniciato a polveri epossidiche in colore nero opaco.
Cuscini. In poliuretano espanso schiumato a freddo in stampo; nel cuscino di seduta è inserito un pannello di multistrato di faggio. La schiuma poliuretana soddisfa la classe 1 IM di resistenza al fuoco secondo la legge italiana ed è disponibile anche secondo altri standard internazionali.
Rivestimento. Disponibile in tessuto o pelle con cinghie in cuoio che uniscono il cuscino di seduta con quello di schienale. Non sfoderabile.

Frame. In tubular steel chromed or epoxy powder painted in black color matt.
Cushions. In cold formed polyurethane foam made in mould; the seat cushion has a frame in beech multiply wood. The foam complies with the Italian Classe 1IM fire resistant law and is available on request for other international standards.
Covers. Available in fabric or leather with saddle leather straps that unite the set cushion with the back cushion. Non removable.



TUCROMSEDIASB

I Sedia con struttura laccata nera o cromata.
 E Chair with black lacquered or chromed frame.
 F Chaise avec structure laquée noire ou chromée.
 D Stuhl mit schwarzem lackiertem oder verchromtem Gestell.
 S Silla con estructura pintada en negro o cromada.

cm. 53 x 64 x h 83 – hs 49 • mt. 1.45
 in. 20⁷/₈ x 25¹/₄ x h 32³/₄ – hs 19³/₄ • yd. 1.60

COM	966,00
L	994,00
T	1.028,00
S	1.056,00
Z	1.090,00
K	1.119,00
PS	1.125,00
PF	1.197,00
PX	1.358,00
PA	1.477,00

TUCROMSUPCRNE

I Supplemento per basamento cromato nero.
 E Extra charge for black chromed base.
 F Supplément pour piétement chromé noir.
 D Mehrpreis fuer schwarz verchromtem Gestell.
 S Suplemento para la base cromada negra.

83,00

VOILE - Design Alessandro Dubini



Struttura. In tubolare d'acciaio. L'imbottitura della struttura è ottenuta con una lastra di poliuretano espanso indeformabile ed esente da CFC.

Base. Disponibile in due varianti: a) in massello di noce canaletto con finitura a "effetto cera"; b) in acciaio cromato o verniciato a polveri epossidiche in colore RAL a scelta.

Rivestimento. Disponibile in cuoio; non sfoderabile.

Frame. In tubular steel. The framework is upholstered with a contoured sheet of resilient, CFC-free polyurethane foam.

Base. Available in two versions: a) in solid black walnut heartwood with "wax effect" finishing; b) in steel available chromed or epoxy powder painted in RAL colors of your choice.

Covers. Available in saddle leather; non removable covers.



VOILE0SEDIACU

I Sedia in noce canaletto e cuoio.

E Chair in black walnut wood and saddle leather

F Chaise en noyer d'Amerique et cuir épais

D Stuhl mit Amerikanische Nussbaum und Rindleder.

S Silla en nogal americano y cuero.

CV 1.730,00

CF 1.527,00

CS 1.289,00

cm. 55 x 56 x h 78 – hs 47
in. 21³/₄ x 22" x h 30³/₄ – hs 18¹/₂



VOILE0SEDICRO

I Sedia in cuoio con base cromata.

E Chair in saddle leather with chromed base.

F Chaise en cuir épais et piètement chromé.

D Stuhl in Rindleder mit verchromtem Gestell.

S Silla en cuero con base cromada.

CV 2.186,00

CF 1.979,00

CS 1.719,00

cm. 55 x 56 x h 78 – hs 47
in. 21³/₄ x 22" x h 30³/₄ – hs 18¹/₂

VOILE0SUPCRNE

I Supplemento per basamento cromato nero.

E Extra charge for black chromed base.

F Supplément pour piètement chromé noir.

D Mehrpreis fuer schwarz verchromtem Gestell.

S Suplemento para la base cromada negra.

113,00

VOILE0SUPLACC

I Supplemento per basamento laccato RAL.

E Extra charge for lacquered base in RAL colour.

F Supplément pour piètement laqué en couleur RAL.

D Mehrpreis fuer Gestell RAL Farbe lackiert.

S Suplemento para la base pintada en color RAL.

91,00

WAY - Design Daniele Lo Scalzo Moscheri



Tavolo **Piano.** E' disponibile in tre versioni: a) in cristallo temperato bronzato; b) in marmo; c) in pannello truciolare impiallacciato in noce canaletto con finitura "effetto cera" e intarsiato.
Base. In legno massello di noce canaletto con finitura "effetto cera".
Sedia **Struttura.** In multistrato di pioppo curvato in stampo. L'imbottitura della struttura è ottenuta con una lastra di poliuretano espanso indeformabile con densità 20÷30 kg/m³ esente da CFC.
Gambe. In massello di noce canaletto con finitura a "effetto cera".
Rivestimento. Disponibile in tessuto o pelle in versione liscia o a canne verticali. Non sfoderabile.

Table **Top.** Is available in three versions: a) in tempered bronzed glass; b) in marble; c) in chipboard panel veneered in black walnut wood with "wax effect" finishing and with crossed veneer.
Base. In solid black walnut wood with "wax effect" finishing.
Chair **Frame.** In poplar plywood curved into a mould. The framework is upholstered with a contoured sheet of resilient, CFC-free polyurethane foam with density of 20÷30 kg/m³.
Legs. In solid black walnut heartwood with "wax effect" finishing.
Covers. Available in fabric or leather in smooth version or with vertical canes. Non removable.



WAY000SEDIA01

I Sedia imbottita con gambe in noce canaletto.
 E Upholstered chair with legs in black walnut.
 F Chaise rembourrée avec pieds en noyer d'Amérique.
 D Gepolstert Stuhl mit Beinen in Amerikanische Nussbaum.
 S Silla rellena con patas en nogal americano.

cm. 54 x 60 x h 77 – hs 45 • mt. 2.20
 in. 21³/₄ x 23³/₄ x h 30³/₄ – hs 17³/₄ • yd. 2.40

COM	1.497,00
L	1.534,00
T	1.580,00
S	1.617,00
Z	1.663,00
K	1.701,00
PS	1.806,00
PF	1.938,00
PX	2.150,00
PA	2.348,00



WAY000SEDIA02

I Sedia imbottita non trapuntata con gambe in noce canaletto.
 E Upholstered chair not quilted with legs in black walnut.
 F Chaise rembourrée pas matelassé avec pieds en noyer d'Amérique.
 D Gepolstert Stuhl nicht gesteppt mit Beinen in Amerikanische Nussbaum.
 S Silla rellena non acolchada con patas en nogal americano.

cm. 54 x 60 x h 77 – hs 45 • mt. 2.20
 in. 21³/₄ x 23³/₄ x h 30³/₄ – hs 17³/₄ • yd. 2.40

COM	1.393,00
L	1.432,00
T	1.478,00
S	1.517,00
Z	1.564,00
K	1.603,00
PS	1.711,00
PF	1.847,00
PX	2.065,00
PA	2.269,00

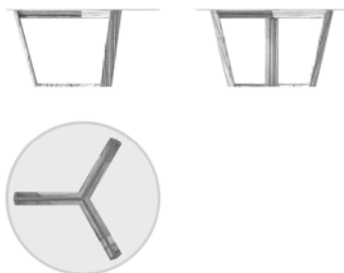

WAY000TA140CR

I Tavolo Ø cm. 140 in cristallo bronzato e temperato. Base in noce canaletto.
 E Table Ø cm. 140 in bronzed and tempered glass. Base in black walnut wood.
 F Table Ø cm. 140 en cristal bronzé et trempé. Piétement en noyer d'Amérique.
 D Tisch Ø cm. 140 in gehärtetem bronzefarbe Glas. Gestell in Amerikanische Nussbaumholz.
 S Mesa Ø cm. 140 en cristal templado y bronceado. Base en nogal americano.

cm. 140 x 140 x h 72.5
 in. 55¹/₂ x 55¹/₂ x h 28¹/₂

4.414,00

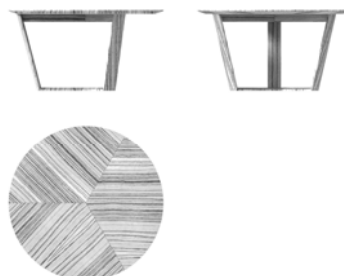

WAY000TA140ES

I Tavolo Ø cm. 140 in noce canaletto a venatura incrociata. Base in noce canaletto.
 E Table Ø cm. 140 in black walnut wood with crossed veneer. Base in black walnut wood.
 F Table Ø cm. 140 en noyer d'Amérique avec placage intersecté. Piétement en noyer d'Amérique.
 D Tisch Ø cm. 140 in Amerikanische Nussbaum mit verkreuzt Maserung. Gestell in Amerikanische Nussbaumholz.
 S Mesa Ø cm. 140 en nogal Americano con chapa cruzado. Base en nogal americano.

cm. 140 x 140 x h 74
 in. 55¹/₂ x 55¹/₂ x h 29¹/₂

5.693,00

WAY - Design Daniele Lo Scalzo Moscheri

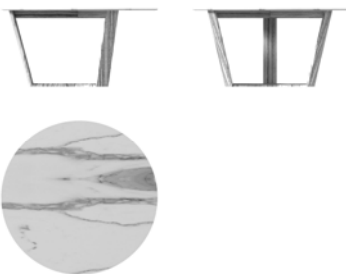

WAY000TA140MC / WAY000TA140MM

I Tavolo Ø cm. 140 in marmo calacatta oro (codice **MOORE0TA140MC**) o Marron Damasco, nero marquina, marron emperador o bianco carrara gioia (codice **MOORE0TA140MM**). Base in noce canaletto.
E Table Ø cm. 140 in Calacatta Oro Marble (code **MOORE0TA140MC**) or in Marron Damasco, black Marquina, Marron Emperador or White Carrara Gioia marble (code **MOORE0TA140MM**). Base in black walnut wood.
F Table Ø cm. 140 en marbre Calacatta Oro (code **MOORE0TA140MC**) ou en marbre Marron Damasco, noir Marquina, Marron Emperador ou blanc Carrara Gioia (code **MOORE0TA140MM**). Piétement en noyer d'Amérique.
D Tisch Ø cm. 140 in Calacatta Oro Marmor (Code **MOORE0TA140MC**) oder in Marmor Marron Damasco, Marmor Marquina schwarz, Marmor Marron Emperador oder weissen Marmor Carrara Gioia (Code **MOORE0TA140MM**). Gestell in Amerikanische Nussbaumholz.
S Mesa Ø cm. 140 en mármol Calacatta oro (código **MOORE0TA140MC**) o en mármol Marron Damasco, Marquina negro, Marron Emperador o bien blanco Carrara Gioia (código **MOORE0TA140MM**). Base en nogal americano.

MC 6.787,00
MM 5.770,00

cm. 140 x 140 x h 74
in. 55"½ x 55"½ x h 29"¼

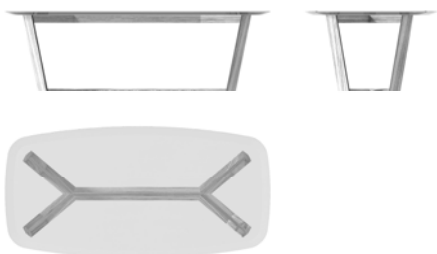

WAY000TA240CR

I Tavolo ovale cm. 240x120 in cristallo bronzato e temperato. Base in noce canaletto.
E Oval table cm. 240x120 in bronzed and tempered glass. Base in black walnut.
F Table ovale cm. 240x120 in cristal bronzé et trempé. Piétement en noyer d'Amérique.
D Oval Tisch cm. 240x120 in gehärtem bronzefarbe Glas. Gestell in Amerikanische Nussbaumholz.
S Mesa oval cm. 240x120 en cristal templado y bronceado. Base en nogal americano.

5.629,00

cm. 240 x 120 x h 72.5
in. 94"½ x 47"¼ x h 28"½

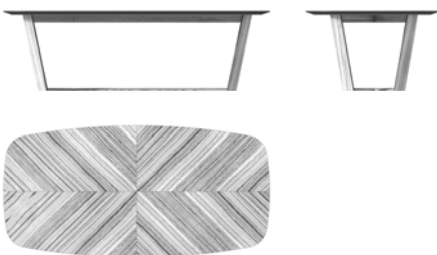

WAY000TA240ES

I Tavolo ovale cm. 240x120 in noce canaletto a venatura incrociata. Base in noce canaletto.
E Oval table cm. 240x120 in black walnut wood with crossed veneer. Base in black walnut wood.
F Table ovale cm. 240x120 en noyer d'Amérique avec placage intersecté. Piétement en noyer d'Amérique.
D Oval Tisch cm. 240x120 in Amerikanische Nussbaum mit verkreuzt Maserung. Gestell in Amerikanische Nussbaumholz.
S Mesa oval cm. 240x120 en nogal Americano con chapa cruzado. Base en nogal americano.

6.794,00

cm. 240 x 120 x h 74
in. 94"½ x 47"¼ x h 29"¼

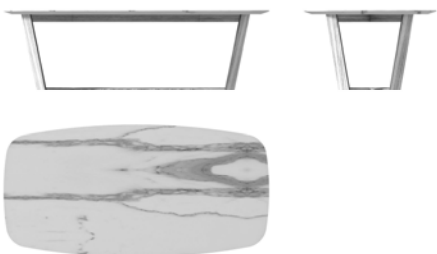

WAY000TA240MC / WAY000TA240MM

I Tavolo ovale cm. 240x120 in marmo calacatta oro (codice **MOORE0TA240MC**) o Marron Damasco, nero marquina, marron emperador o bianco carrara gioia (codice **MOORE0TA240MM**). Base in noce canaletto.
E Oval table cm. 240x120 in Calacatta Oro Marble (code **MOORE0TA240MC**) or in Marron Damasco, black Marquina, Marron Emperador or White Carrara Gioia marble (code **MOORE0TA240MM**). Base in black walnut.
F Table ovale cm. 240x120 en marbre Calacatta Oro (code **MOORE0TA240MC**) ou en marbre Marron Damasco, noir Marquina, Marron Emperador ou blanc Carrara Gioia (code **MOORE0TA240MM**). Piétement en noyer d'Amérique.
D Oval Tisch cm. 240x120 in Calacatta Oro Marmor (Code **MOORE0TA240MC**) oder in Marmor Marron Damasco, Marmor Marquina schwarz, Marmor Marron Emperador oder weissen Marmor Carrara Gioia (Code **MOORE0TA240MM**). Gestell in Amerikanische Nussbaumholz.
S Mesa oval cm. 240x120 en mármol Calacatta oro (código **MOORE0TA240MC**) o en mármol Marron Damasco, Marquina negro, Marron Emperador o bien blanco Carrara Gioia (código **MOORE0TA240MM**). Base en nogal americano.

MC 9.055,00
MM 7.692,00

cm. 240 x 120 x h 74
in. 94"½ x 47"¼ x h 29"¼

YORK - Design Alessandro Dubini



Piano. E' disponibile in cristallo extralight temperato.

Base. In legno massello di noce canaletto con finitura "effetto cera".

Top. Is available in extralight tempered glass.

Base. In solid black walnut wood with "wax effect" finishing.

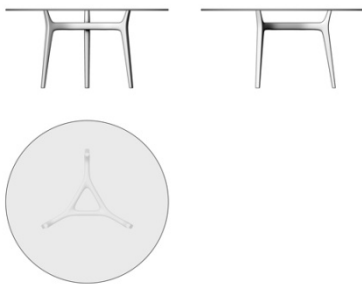

YORK00TT150EX

I Tavolo Ø cm. 150 con base in noce canaletto e piano in cristallo extrachiaro.

E Table Ø cm. 150 with black walnut base and top in extraclear glass.

F Table Ø cm. 150 avec piètement en noyer d'Amérique et plan en verre superclair.

D Tisch Ø cm. 150 mit Gestell in Amerikanische Nussbaumholz und Platte in Durchsichtig Glass.

S Mesa Ø cm. 150 con base en nogal Americano y tapa en cristal extraclaro.

3.675,00

cm. 150 x 150 x h 73
in. 59" x 59" x h 28³/₄

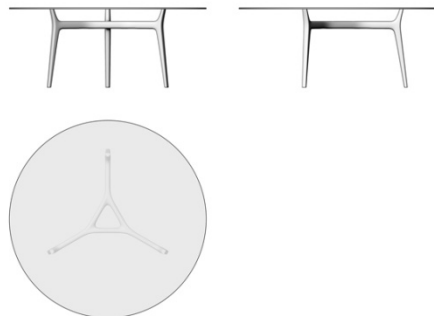

YORK00TT180EX

I Tavolo Ø cm. 180 con base in noce canaletto e piano in cristallo extrachiaro.

E Table Ø cm. 180 with black walnut base and top in extraclear glass.

F Table Ø cm. 180 avec piètement en noyer d'Amérique et plan en verre superclair.

D Tisch Ø cm. 180 mit Gestell in Amerikanische Nussbaumholz und Platte in Durchsichtig Glass.

S Mesa Ø cm. 180 con base en nogal Americano y tapa en cristal extraclaro.

4.167,00

cm. 180 x 180 x h 73
in. 70³/₄ x 70³/₄ x h 28³/₄

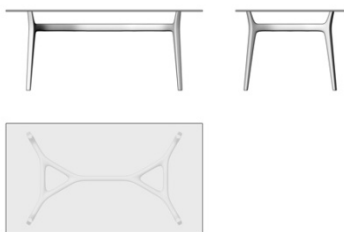

YORK00TA180EX

I Tavolo cm. 180X100 con base in noce canaletto e piano in cristallo extrachiaro.

E Table cm. 180X100 with black walnut base and top in extraclear glass.

F Table cm. 180X100 avec piètement en noyer d'Amérique et plan en verre superclair.

D Tisch cm. 180X100 mit Gestell in Amerikanische Nussbaumholz und Platte in Durchsichtig Glass.

S Mesa cm. 180X100 con base en nogal Americano y tapa en cristal extraclaro.

4.756,00

cm. 180 x 100 x h 73
in. 70³/₄ x 39³/₄ x h 28³/₄

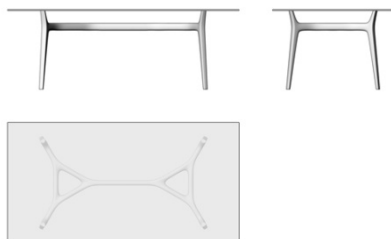

YORK00TA210EX

I Tavolo cm. 210X110 con base in noce canaletto e piano in cristallo extrachiaro.

E Table cm. 210X110 with black walnut base and top in extraclear glass.

F Table cm. 210X110 avec piètement en noyer d'Amérique et plan en verre superclair.

D Tisch cm. 210X110 mit Gestell in Amerikanische Nussbaumholz und Platte in Durchsichtig Glass.

S Mesa cm. 210X110 con base en nogal Americano y tapa en cristal extraclaro.

5.005,00

cm. 210 x 110 x h 73
in. 82³/₄ x 43³/₄ x h 28³/₄

YORK - Design Alessandro Dubini

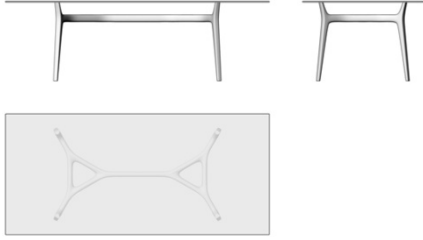

YORK00TA240EX

I Tavolo cm. 240X110 con base in noce canaletto e piano in cristallo extrachiaro.

E Table cm. 240X110 with black walnut base and top in extraclear glass.

F Table cm. 240X110 avec piètement en noyer d'Amérique et plan en verre superclair.

D Tisch cm. 240X110 mit Gestell in Amerikanische Nussbaumholz und Platte in Durchsichtig Glass.

S Mesa cm. 240X110 con base en nogal Americano y tapa en cristal extraclaro.

5.314,00

cm. 240 x 110 x h 73

in. 94 $\frac{1}{2}$ x 43 $\frac{1}{4}$ x h 28 $\frac{3}{4}$

**LETTI
BEDS
LITS
BETTEN
CAMAS**

ADD_LOOK - Design Mauro Lipparini



Struttura. La testata e i fianchi laterali sono in legno massello di pioppo (stagionato "naturalmente" per almeno 3 anni) con elementi in multistrato di pioppo; giunzioni a incastro con spine cilindriche. L'imbottitura è ottenuta con lastre di poliuretano espanso indeformabile con densità di 30 kg/m³ esente da CFC ricoperto da ovatta poliestere e vellutino accoppiato. Testata e fianchi laterali sono fissati a una struttura d'acciaio sulla quale è poggiata una rete a doghe in legno.

Base. Piedini in tubolare d'acciaio. Disponibili in finitura cromata o verniciata a polveri epossidiche in colore RAL a scelta.

Rivestimento. Disponibile in tessuto e pelle; sfoderabile solo nella versione in tessuto.

Frame. Headboard and lateral bands are in solid poplar heartwood ("naturally" seasoned for at least 3 years) with connecting elements in poplar plywood; dap joints with cylindrical dowels. The framework is upholstered with contoured sheets of resilient, CFC-free polyurethane foam with density of 30 kg/m³ covered by polyester wadding and bonded plush. Headboard and lateral bands are fixed to a metal frame where leans a wooden slatted base.

Base. Supports in tubular steel. Available chromed or epoxy powder painted in RAL colors of your choice.

Covers. Available in fabric or leather; removable covers only for fabric version.



ADLOOKLETT160

I Letto imbottito con piedini in acciaio cromato e con rete a doghe in legno per materasso cm. 160X200 (materasso escluso).

E Upholstered bed with chromed steel feet and with wooden slatted base for mattress cm. 160X200 (mattress not included).

F Lit rembourré avec pieds en acier chrome et avec sommier à lattes pour matelas cm. 160X200 (matelas pas inclus).

D Gepolstertes Bett mit verchromten Fusse und mit Holz-Lattenrost fuer Matratze cm. 160X200 (ohne Matratze).

S Cama rellena con patas en acero cromado y somier con láminas de madera para colchón de cm. 160x200 (colchón no incluido).

cm. 189 x 243 x h 79 • mt. 4.65
in. 74" x 95" x h 31" • yd. 5.10

COM	3.934,00
L	4.024,00
T	4.133,00
S	4.224,00
Z	4.333,00
K	4.176,00
PS	4.943,00
PF	5.281,00
PX	6.021,00
PA	6.580,00



ADLOOKLETT180

I Letto imbottito con piedini in acciaio cromato e con rete a doghe in legno per materasso cm. 180X200 (materasso escluso).

E Upholstered bed with chromed steel feet and with wooden slatted base for mattress cm. 180X200 (mattress not included).

F Lit rembourré avec pieds en acier chrome et avec sommier à lattes pour matelas cm. 180X200 (matelas pas inclus).

D Gepolstertes Bett mit verchromten Fusse und mit Holz-Lattenrost fuer Matratze cm. 180X200 (ohne Matratze).

S Cama rellena con patas en acero cromado y somier con láminas de madera para colchón de cm. 180x200 (colchón no incluido).

cm. 209 x 243 x h 79 • mt. 4.85
in. 82" x 95" x h 31" • yd. 5.30

COM	4.024,00
L	4.119,00
T	4.233,00
S	4.329,00
Z	4.443,00
K	4.538,00
PS	5.078,00
PF	5.433,00
PX	6.202,00
PA	6.786,00



ADLOOKLETT200

I Letto imbottito con piedini in acciaio cromato e con rete a doghe in legno per materasso cm. 200X200 (materasso escluso).

E Upholstered bed with chromed steel feet and with wooden slatted base for mattress cm. 200X200 (mattress not included).

F Lit rembourré avec pieds en acier chrome et avec sommier à lattes pour matelas cm. 200X200 (matelas pas inclus).

D Gepolstertes Bett mit verchromten Fusse und mit Holz-Lattenrost fuer Matratze cm. 200X200 (ohne Matratze).

S Cama rellena con patas en acero cromado y somier con láminas de madera para colchón de cm. 200x200 (colchón no incluido).

cm. 229 x 243 x h 79 • mt. 5.25
in. 90" x 95" x h 31" • yd. 5.75

COM	4.257,00
L	4.376,00
T	4.519,00
S	4.638,00
Z	4.780,00
K	4.986,00
PS	5.332,00
PF	5.713,00
PX	6.548,00
PA	7.177,00

BE_LOOK - Design Mauro Lipparini



Struttura. La testata e i fianchi laterali sono in legno massello di pioppo (stagionato "naturalmente" per almeno 3 anni) con elementi in multistrato di pioppo; giunzioni a incastro con spine cilindriche. L'imbottitura è ottenuta con lastre di poliuretano espanso indeformabile con densità di 30 kg/m³ esente da CFC ricoperto da ovatta poliestere e vellutino accoppiato. Testata e fianchi laterali sono fissati a una struttura d'acciaio sulla quale è poggiata una rete a doghe in legno.

Base. Piedini in PVC nero.

Rivestimento. Disponibile in tessuto e pelle; sfoderabile solo nella versione in tessuto.

Frame. Headboard and lateral bands are in solid poplar heartwood ("naturally" seasoned for at least 3 years) with connecting elements in poplar plywood; dap joints with cylindrical dowels. The framework is upholstered with contoured sheets of resilient, CFC-free polyurethane foam with density of 30 kg/m³ covered by polyester wadding and bonded plush. Headboard and lateral bands are fixed to a metal frame where leans a wooden slatted base.

Base. Supports in black PVC.

Covers. Available in fabric or leather; removable covers only for fabric version.



BELOOKLETT160

- I Letto imbottito con rete a doghe in legno per materasso cm. 160X200 (materasso escluso).
- E Upholstered bed with wooden slatted base for mattress cm. 160X200 (mattress not included).
- F Lit rembourré avec sommier à lattes pour matelas cm. 160X200 (matelas pas inclus).
- D Gepolstertes Bett mit Holz-Lattenrost fuer Matratze cm. 160X200 (ohne Matratze).
- S Cama rellena con somier con láminas de madera para colchón de cm. 160x200 (colchón no incluido).

COM	3.701,00
L	3.833,00
T	3.991,00
S	4.123,00
Z	4.282,00
K	4.414,00
PS	5.088,00
PF	5.577,00
PX	6.635,00
PA	7.441,00



cm. 189 x 243 x h 77 • mt. 6.70
in. 74" x 95" x h 30" • yd. 7.35



BELOOKLETT180

- I Letto imbottito con rete a doghe in legno per materasso cm. 180X200 (materasso escluso).
- E Upholstered bed with wooden slatted base for mattress cm. 180X200 (mattress not included).
- F Lit rembourré avec sommier à lattes pour matelas cm. 180X200 (matelas pas inclus).
- D Gepolstertes Bett mit Holz-Lattenrost fuer Matratze cm. 180X200 (ohne Matratze).
- S Cama rellena con somier con láminas de madera para colchón de cm. 180x200 (colchón no incluido).

COM	3.876,00
L	4.017,00
T	4.186,00
S	4.326,00
Z	4.495,00
K	4.635,00
PS	5.338,00
PF	5.858,00
PX	6.989,00
PA	7.846,00



cm. 209 x 243 x h 77 • mt. 7.15
in. 82" x 95" x h 30" • yd. 7.80



BELOOKLETT200

- I Letto imbottito con rete a doghe in legno per materasso cm. 200X200 (materasso escluso).
- E Upholstered bed with wooden slatted base for mattress cm. 200X200 (mattress not included).
- F Lit rembourré avec sommier à lattes pour matelas cm. 200X200 (matelas pas inclus).
- D Gepolstertes Bett mit Holz-Lattenrost fuer Matratze cm. 200X200 (ohne Matratze).
- S Cama rellena con somier con láminas de madera para colchón de cm. 200x200 (colchón no incluido).

COM	3.998,00
L	4.148,00
T	4.327,00
S	4.476,00
Z	4.656,00
K	4.804,00
PS	5.549,00
PF	6.103,00
PX	7.289,00
PA	8.198,00



cm. 229 x 243 x h 77 • mt. 7.60
in. 90" x 95" x h 30" • yd. 8.30

BRERA - Design Luca Scacchetti



Struttura. La testata e i fianchi laterali sono composti di diverse parti realizzate in legno massello di pioppo (stagionato "naturalmente" per almeno 3 anni) con elementi in multistrato di pioppo e pannello nobilitato; giunzioni a incastro con spine cilindriche. L'imbottitura è ottenuta con una lastra di poliuretano espanso indeformabile con densità di 70 kg/m³ esente da CFC. Testata e fianchi laterali sono rivestiti in cuoio e fissati a una struttura d'acciaio sulla quale è poggiata una rete a doghe in legno.

Base. Piedini in acciaio verniciato a polveri epossidiche in colore grigio chiaro opaco.

Rivestimento. Disponibile in cuoio; non sfoderabile.

Frame. Headboard and lateral bands are made with different materials: solid poplar heartwood ("naturally" seasoned for at least 3 years) with connecting elements in poplar plywood and melamine coated panels; dap joints with cylindrical dowels. The framework is upholstered with contoured sheets of resilient, CFC-free polyurethane foam with density of 70 kg/m³. Headboard and lateral bands are covered in saddle leather and then are fixed to a metal frame where leans a wooden slatted base.

Base. Supports in steel epoxy powder painted in matt light grey color.

Covers. Available in saddle leather; non removable covers.



BRERA0LETT179

I Letto in cuoio con testata curva. Rete a doghe in legno per materasso da cm. 170x200 (materasso escluso).

E Bed in saddle leather with curved headboard. Wooden slatted base for mattress cm. 170x200 (mattress not included).

F Lit en cuir épais avec tête arrondie. Sommier à lattes de bois pour matelas cm. 170x200 (matelas pas inclus).

D Rindleder Bett mit geschwungenem Kopfteil. Holz-Lattenrost fuer Matratze cm. 170x200 (ohne Matratze).

S Cama en cuero con cabezal curvo. Somier con láminas de madera para colchón de cm.170x200 (colchón no incluido).

CV 5.600,00
CF 4.698,00
CS 4.256,00

cm. 179.5 x 215 x h 90
in. 70¹/₂ x 84³/₄ x h 35¹/₂



BRERA0LETT199

I Letto in cuoio con testata curva. Rete a doghe in legno per materasso da cm. 190x200 (materasso escluso).

E Bed in saddle leather with curved headboard. Wooden slatted base for mattress cm. 190x200 (mattress not included).

F Lit en cuir épais avec tête arrondie. Sommier à lattes de bois pour matelas cm. 190x200 (matelas pas inclus).

D Rindleder Bett mit geschwungenem Kopfteil. Holz-Lattenrost fuer Matratze cm. 190x200 (ohne Matratze).

S Cama en cuero con cabezal curvo. Somier con láminas de madera para colchón de cm.190x200 (colchón no incluido).

CV 5.441,00
CF 5.063,00
CS 4.591,00

cm. 199.5 x 215 x h 90
in. 78¹/₂ x 84³/₄ x h 35¹/₂



Letto **Struttura.** La testata è in tubolare d'acciaio verniciata a polveri epossidiche in colore titanio e rivestita in cuoio con dettaglio di stringa di cuoio in colore testa di moro. I fianchi laterali sono in pannello nobilitato imbottiti con una lastra di poliuretano espanso indeformabile con densità di 70 kg/m³ esente da CFC e rivestita in tessuto o pelle. Testata e fianchi laterali sono fissati a una struttura d'acciaio sulla quale è poggiata una rete a doghe in legno.
Base. In tubolare d'acciaio verniciata a polveri epossidiche in colore titanio.
Comodino **Struttura.** In tubolare d'acciaio verniciata a polveri epossidiche in colore titanio. Piano superiore in acciaio rivestito in cuoio. Parte intermedia in pannello nobilitato rivestito in cuoio con maniglia in massello di noce canaletto tinto grigio.
Comò **Struttura.** La parte esterna è in multistrato di faggio curvato in stampo e imbottita con una lastra di poliuretano espanso indeformabile con densità di 70 kg/m³ esente da CFC poi rivestita in cuoio o pelle. La parte interna è in nobilitato rivestito in cuoio o pelle.
Piano. Disponibile in marmo e in pannello truciolare impiallacciato in noce canaletto tinto grigio. La vanity è dotata di specchio imbottito e rivestito in cuoio o pelle.

Bed **Frame.** The headboard is in tubular steel epoxy powder painted in titanium color and covered in saddle leather with a dark brown saddle leather string inlay. The lateral bands are in melamine coated panel upholstered with a sheet of resilient, CFC-free polyurethane foam with density of 70 kg/m³ and covered in fabric or leather. Headboard and lateral bands are covered in saddle leather and then are fixed to a metal frame where leans a wooden slatted base.
Base. In tubular steel epoxy powder painted in titanium color.
Night table **Frame.** In tubular steel epoxy powder painted in titanium color. Top in metal sheet covered in saddle leather. Lower frame in melamine coated panel covered in saddle leather with handle in grey stained solid black walnut wood.
Chest of drawers **Frame.** Outside frame in beech plywood curved into a mould upholstered with a sheet of resilient, CFC-free polyurethane foam with density of 70 kg/m³ covered in saddle leather or leather.
Top. Available in marble or in chipboard panel veneered in grey stained black walnut wood. Handles in solid grey stained black walnut wood. The vanity is equipped with a mirror upholstered and covered in saddle leather or leather.

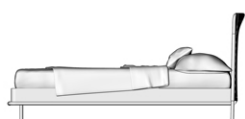
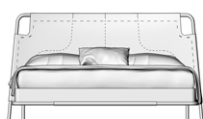

I Letto con testata in cuoio (cat. CS, CF o CV) con rete a doghe in legno per materasso cm. 160x200. Fianchi rivestiti in tessuto o pelle e struttura in acciaio verniciata color titanio. Materasso non incluso.
 E Bed with headboard covered in saddle leather (cat. CS, CF or CV) with wooden slatted base for mattress cm. 160x200. Sides upholstered in fabric or leather and steel frame varnished color Titanium. Mattress not included.
 F Lit avec tête en cuir épais (cat. CS, CF, CV) avec sommier à lattes pour matelas cm. 160x200. Côtés revêtus en tissu ou en cuir souple et structure en acier verni en couleur titane. Matelas pas inclus.
 D Bett mit Rindleder Kopfteil (cat. CS, CF oder CV) mit Holz-Lattenrost fuer matratze cm. 160x200. Seiten mit Stoff oder Leder bezogen und Stahlstruktur lackiertem titanium Farbe. Ohne Matratze.
 S Cama con cabezal en cuero (cat. CS, CF o CV) con somier con laminas de Madera para colchón de cm. 160x200. Laterales tapizados en tejido o piel y estructura de acero pintado color titanio. Colchón no incluido.

cm. 185 x 220 x h 100 • mt. 2.90
 in. 72" x 86" x h 39" • yd. 3.17

	JEANMALE160CS Cat. CS	JEANMALE160CF Cat. CF	JEANMALE160CV Cat. CV
COM	4.369,00	5.018,00	5.537,00
L	4.425,00	5.074,00	5.593,00
T	4.493,00	5.142,00	5.661,00
S	4.548,00	5.197,00	5.717,00
Z	4.616,00	5.265,00	5.784,00
K	4.673,00	5.322,00	5.841,00
PS	4.749,00	5.398,00	5.917,00
PF	4.913,00	5.562,00	6.081,00
PX	5.176,00	5.825,00	6.344,00
PA	5.423,00	6.072,00	6.591,00

JEAN MARIE - Design Umberto Asnago



	JEANMALE180CS Cat. CS	JEANMALE180CF Cat. CF	JEANMALE180CV Cat. CV
I Letto con testata in cuoio (cat. CS, CF o CV) con rete a doghe in legno per materasso cm. 180x200. Fianchi rivestiti in tessuto o pelle e struttura in acciaio verniciata color titanio. Materasso non incluso.	COM 4.391,00	COM 5.040,00	COM 5.559,00
E Bed with headboard covered in saddle leather (cat. CS, CF or CV) with wooden slatted base for mattress cm. 180x200. Sides upholstered in fabric or leather and steel frame varnished color Titanium. Mattress not included.	L 4.447,00	L 5.095,00	L 5.615,00
F Lit avec tête en cuir épais (cat. CS, CF, CV) avec sommier à lattes pour matelas cm. 180x200. Côtés revêtus en tissu ou en cuir souple et structure en acier verni en couleur titane. Matelas pas inclus.	T 4.514,00	T 5.163,00	T 5.683,00
D Bett mit Rindleder Kopfteil (cat. CS, CF oder CV) mit Holz-Lattenrost fuer matratze cm. 180x200. Seiten mit Stoff oder Leder bezogen und Stahlstruktur lackiertem titanium Farbe. Ohne Matratze.	S 4.570,00	S 5.219,00	S 5.738,00
S Cama con cabezal en cuero (cat. CS, CF o CV) con somier con laminas de Madera para colchón de cm. 180x200. Laterales tapizados en tejido o piel y estructura de acero pintado color titanio. Colchón no incluido.	Z 4.638,00	Z 5.287,00	Z 5.806,00
	K 4.695,00	K 5.344,00	K 5.863,00
	PS 4.771,00	PS 5.420,00	PS 5.939,00
	PF 4.935,00	PF 5.584,00	PF 6.103,00
	PX 5.197,00	PX 5.846,00	PX 6.365,00
	PA 5.445,00	PA 6.093,00	PA 6.613,00

cm. 205 x 220 x h 100 • mt. 2.90
in. 80"½ x 86"¾ x h 39"¾ • yd. 3.17



	JEANMALE200CS Cat. CS	JEANMALE200CF Cat. CF	JEANMALE200CV Cat. CV
I Letto con testata in cuoio (cat. CS, CF o CV) con rete a doghe in legno per materasso cm. 200x200. Fianchi rivestiti in tessuto o pelle e struttura in acciaio verniciata color titanio. Materasso non incluso.	COM 4.490,00	COM 5.139,00	COM 5.658,00
E Bed with headboard covered in saddle leather (cat. CS, CF or CV) with wooden slatted base for mattress cm. 200x200. Sides upholstered in fabric or leather and steel frame varnished color Titanium. Mattress not included.	L 4.546,00	L 5.195,00	L 5.714,00
F Lit avec tête en cuir épais (cat. CS, CF, CV) avec sommier à lattes pour matelas cm. 200x200. Côtés revêtus en tissu ou en cuir souple et structure en acier verni en couleur titane. Matelas pas inclus.	T 4.613,00	T 5.262,00	T 5.781,00
D Bett mit Rindleder Kopfteil (cat. CS, CF oder CV) mit Holz-Lattenrost fuer matratze cm. 200x200. Seiten mit Stoff oder Leder bezogen und Stahlstruktur lackiertem titanium Farbe. Ohne Matratze.	S 4.670,00	S 5.319,00	S 5.838,00
S Cama con cabezal en cuero (cat. CS, CF o CV) con somier con laminas de Madera para colchón de cm. 180x200. Laterales tapizados en tejido o piel y estructura de acero pintado color titanio. Colchón no incluido.	Z 4.738,00	Z 5.387,00	Z 5.906,00
	K 4.794,00	K 5.443,00	K 5.962,00
	PS 4.870,00	PS 5.519,00	PS 6.038,00
	PF 5.035,00	PF 5.684,00	PF 6.203,00
	PX 5.297,00	PX 5.946,00	PX 6.465,00
	PA 5.543,00	PA 6.192,00	PA 6.711,00

cm. 225 x 220 x h 100 • mt. 2.90
in. 88"¾ x 86"¾ x h 39"¾ • yd. 3.17



JEANMACOMODIN	
I Comodino rivestito in cuoio e base verniciata colore titanio.	CV 2.589,00
E Night table covered in saddle leather with frame varnished in colour titanium.	CF 2.373,00
F Chevet recouvert de cuir épais avec pietement verni en couleur titane.	CS 2.102,00
D Nachttisch in Leder bezogen mit Fuss lackiertem titanium Farbe.	
S Mesita de noche tapizada en cuero y pata pintada color titanio.	

cm. 67 x 46 x h 54
in. 26"¾ x 18"¾ x h 21"¾

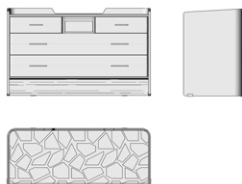

JEANMACOMOTDW	
I Como' rivestito in cuoio o pelle con 4 cassetti e vano a giorno. Top in marmo Dover White.	CV 10.645,00
E Dresser covered in saddle leather or leather, with 4 drawers and an open compartment. Dover White marble top.	CF 10.061,00
F Chiffonnier recouvert en cuir épais ou en cuir souple, avec 4 tiroirs et un compartiment ouvert. Top en marbre Dover White.	CS 9.331,00
D Kommode mit Rindleder oder Leder bezogen, mit 4 Schubladen und einem offenen Fach. Dover Weiße Marmorplatte.	PA 10.440,00
S Vestidor tapizado en cuero o piel, con 4 cajones y un compartimento abierto. Top de mármol Dover White.	PX 10.002,00
	PF 9.535,00
	PS 9.243,00

cm. 133 x 55 x h 80
in. 52"¾ x 21"¾ x h 31"¾

JEAN MARIE - Design Umberto Asnago



JEANMACOMOTNC

I Como' rivestito in cuoio o pelle con 4 cassetti e vano a giorno. Top noce Canaletto tinto grigio.
 E Dresser covered in saddle leather or leather, with 4 drawers and an open compartment. Black walnut wood grey stained top.
 F Chiffonier recouvert en cuir épais ou de cuir souple, avec 4 tiroirs et un compartiment ouvert. Top en noyer d'Amerique teinté gris.
 D Kommode mit Rindleder oder Leder bezogen, mit 4 Schubladen und einem offenen Fach. Platte in Amerikanische Nussbaumholz grau lackiert.
 S Vestidor tapizado en cuero o piel, con 4 cajones y un compartimento abierto. Top en nogal americano teñido de gris.

CV 9.545,00
 CF 8.961,00
 CS 8.231,00
 PA 9.340,00
 PX 8.902,00
 PF 8.436,00
 PS 8.143,00

cm. 133 x 55 x h 80
 in. 52³/₄ x 21³/₄ x h 31¹/₂

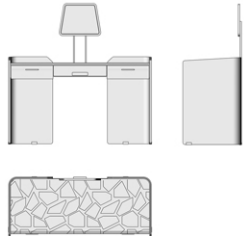

JEANMATOILEDW

I Mobile vanity rivestito in cuoio o pelle con 3 cassetti e specchio. Top in marmo Dover White.
 E Makeup vanity cabinet covered in saddle leather or leather, with 3 drawers and mirror. Dover White marble top.
 F Meuble de maquillage recouvert de cuir épais ou de cuir souple, avec 4 tiroirs et un mirorir. Top en marbre Dover White.
 D Schmink-Toilette mit Rindleder oder Leder bezogen, mit 3 Schubladen und einem Spiegel. Dover Weiße Marmorplatte
 S Mueble de tocador de maquillaje tapizado en cuero o piel, con 3 cajones y un espejo. Top de mármol Dover White.

CV 7.576,00
 CF 7.230,00
 CS 6.797,00
 PA 7.455,00
 PX 7.196,00
 PF 6.919,00
 PS 6.745,00

cm. 133 x 55 x h 80 - 130
 in. 52³/₄ x 21³/₄ x h 31¹/₂ - 51¹/₂

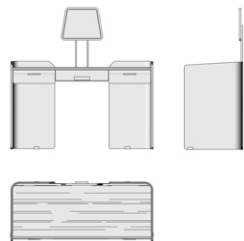

JEANMATOILENC

I Mobile vanity rivestito in cuoio o pelle con 3 cassetti e specchio. Top in noce Canaletto tinto grigio.
 E Makeup vanity cabinet covered in saddle leather or leather, with 3 drawers and mirror. Black walnut wood grey stained top.
 F Meuble de maquillage recouvert de cuir épais ou de cuir souple, avec 4 tiroirs et un mirorir. Top en noyer d'Amerique teinté gris.
 D Kommode mit Rindleder oder Leder bezogen, mit 4 Schubladen und einem offenen Fach. Platte in Amerikanische Nussbaumholz grau lackiert.
 S Mueble de tocador de maquillaje tapizado en cuero o piel, con 3 cajones y un espejo. Top en nogal americano teñido de gris.

CV 6.476,00
 CF 6.130,00
 CS 5.697,00
 PA 6.354,00
 PX 6.095,00
 PF 5.817,00
 PS 5.644,00

cm. 133 x 55 x h 80 - 130
 in. 52³/₄ x 21³/₄ x h 31¹/₂ - 51¹/₂

KEEN - Design Mauro Lipparini



Struttura. La testata e i fianchi laterali sono in legno massello di pioppo (stagionato "naturalmente" per almeno 3 anni) con elementi in multistrato di pioppo e pannelli di nobilitato; giunzioni a incastro con spine cilindriche. L'imbottitura è ottenuta con lastre di poliuretano espanso indeformabile con densità di 30÷75 kg/m³ esente da CFC ricoperto da ovatta poliestere e vellutino accoppiato. Testata e fianchi laterali sono fissati a una struttura d'acciaio sulla quale è poggiata una rete a doghe in legno.

Base. Piedini in tubolare d'acciaio. Disponibili in finitura cromata o verniciata a polveri epossidiche in colore RAL a scelta.

Rivestimento. Disponibile in tessuto e pelle; sfoderabile solo nella versione in tessuto.

Frame. Headboard and lateral bands are in solid poplar heartwood ("naturally" seasoned for at least 3 years) with connecting elements in poplar plywood and chipboard panels; dap joints with cylindrical dowels. The framework is upholstered with contoured sheets of resilient, CFC-free polyurethane foam with density of 30÷75 kg/m³ covered by polyester wadding and bonded plush. Headboard and lateral bands are fixed to a metal frame where leans a wooden slatted base.

Base. Supports in tubular steel. Available chromed or epoxy powder painted in RAL colors of your choice.

Covers. Available in fabric or leather; removable covers only for fabric version.



KEEN00LETT160

I Letto imbottito con piedini in acciaio cromato e con rete a doghe in legno per materasso cm. 160X200 (materasso escluso).

E Upholstered bed with chromed steel feet and with wooden slatted base for mattress cm. 160X200 (mattress not included).

F Lit rembourré avec pieds en acier chrome et avec sommier à lattes pour matelas cm. 160X200 (matelas pas inclus).

D Gepolstertes Bett mit verchromten Fusse und mit Holz-Lattenrost fuer Matratze cm. 160X200 (ohne Matratze).

S Cama rellena con patas en acero cromado y somier con láminas de madera para colchón de cm. 160x200 (colchón no incluido).

cm. 190 x 240 x h 74 • mt. 7.25
in. 74"½ x 94"½ x h 29"½ • yd. 7.95

COM	3.545,00
L	3.688,00
T	3.859,00
S	4.003,00
Z	4.174,00
K	4.317,00
PS	4.960,00
PF	5.488,00
PX	6.633,00
PA	7.504,00



KEEN00LETT180

I Letto imbottito con piedini in acciaio cromato e con rete a doghe in legno per materasso cm. 180X200 (materasso escluso).

E Upholstered bed with chromed steel feet and with wooden slatted base for mattress cm. 180X200 (mattress not included).

F Lit rembourré avec pieds en acier chrome et avec sommier à lattes pour matelas cm. 180X200 (matelas pas inclus).

D Gepolstertes Bett mit verchromten Fusse und mit Holz-Lattenrost fuer Matratze cm. 180X200 (ohne Matratze).

S Cama rellena con patas en acero cromado y somier con láminas de madera para colchón de cm. 180x200 (colchón no incluido).

cm. 210 x 240 x h 74 • mt. 7.70
in. 82"½ x 94"½ x h 29"½ • yd. 8.40

COM	3.625,00
L	3.776,00
T	3.957,00
S	4.109,00
Z	4.290,00
K	4.441,00
PS	5.127,00
PF	5.690,00
PX	6.915,00
PA	7.843,00



KEEN00LETT200

I Letto imbottito con piedini in acciaio cromato e con rete a doghe in legno per materasso cm. 200X200 (materasso escluso).

E Upholstered bed with chromed steel feet and with wooden slatted base for mattress cm. 200X200 (mattress not included).

F Lit rembourré avec pieds en acier chrome et avec sommier à lattes pour matelas cm. 200X200 (matelas pas inclus).

D Gepolstertes Bett mit verchromten Fusse und mit Holz-Lattenrost fuer Matratze cm. 200X200 (ohne Matratze).

S Cama rellena con patas en acero cromado y somier con láminas de madera para colchón de cm. 200x200 (colchón no incluido).

cm. 230 x 240 x h 74 • mt. 8.15
in. 90"½ x 94"½ x h 29"½ • yd. 8.90

COM	3.779,00
L	3.940,00
T	4.131,00
S	4.292,00
Z	4.484,00
K	4.643,00
PS	5.357,00
PF	5.949,00
PX	7.224,00
PA	8.198,00



KRISTALL - Design Mauro Lipparini



Struttura. La testata è in pannello nobilitato imbottita con lastre di poliuretano espanso indeformabile con densità di 30÷75 kg/m³ esente da CFC ricoperto da ovatta poliestere e vellutino accoppiato. La testata è poi fissata alla base in acciaio.

Base. In tubolare d'acciaio. Disponibile in finitura cromata o verniciata a polveri epossidiche in colore RAL a scelta. Alla base è fissata una struttura in acciaio sulla quale è poggiata una rete a doghe in legno.

Rivestimento. Disponibile in tessuto e pelle; non sfoderabile.

Frame. The headboard is in chipboard panels upholstered with contoured sheets of resilient, CFC-free polyurethane foam with density of 30÷75 kg/m³ covered by polyester wadding and bonded plush. The headboard is then fixed to the metal base.

Base. In tubular steel. Available chromed or epoxy powder painted in RAL colors of your choice. A metal frame where a wooden slatted base leans is fixed to the base.

Covers. Available in fabric or leather; non removable covers.



KRISTALETT160

I Letto con struttura in tubolare tondo cromato o verniciato con rete a doghe in legno per materasso cm.160X200 (materasso escluso).

E Bed with round tubular steel frame chromed or varnished, with wooden slatted base for mattress cm. 160X200 (mattress not included).

F Lit avec structure en métal tubulaire rond chromé ou verni avec sommier à lattes pour matelas cm. 160X200 (matelas pas inclus).

D Bett mit rohre runde verchromten oder lackierten Gestell; Holz-Lattenrost fuer Matratze cm. 160X200 (ohne Matratze).

S Cama con estructura en tubo de acero redondo cromado o pintado; somier con láminas de madera para colchón de cm. 160x200 (colchón no incluido).

cm. 160 x 225 x h 80 • mt. 2.75
in. 63" x 88"½ x h 31"½ • yd. 3.00

COM	4.348,00
L	4.402,00
T	4.467,00
S	4.521,00
Z	4.586,00
K	4.640,00
PS	4.900,00
PF	5.104,00
PX	5.554,00
PA	5.892,00



KRISTALETT180

I Letto con struttura in tubolare tondo cromato o verniciato con rete a doghe in legno per materasso cm.180X200 (materasso escluso).

E Bed with round tubular steel frame chromed or varnished, with wooden slatted base for mattress cm. 180X200 (mattress not included).

F Lit avec structure en métal tubulaire rond chromé ou verni avec sommier à lattes pour matelas cm. 180X200 (matelas pas inclus).

D Bett mit rohre runde verchromten oder lackierten Gestell; Holz-Lattenrost fuer Matratze cm. 180X200 (ohne Matratze).

S Cama con estructura en tubo de acero redondo cromado o pintado; somier con láminas de madera para colchón de cm. 180x200 (colchón no incluido).

cm. 180 x 225 x h 80 • mt. 3.00
in. 70"¾ x 88"½ x h 31"½ • yd. 3.30

COM	4.452,00
L	4.510,00
T	4.580,00
S	4.638,00
Z	4.708,00
K	4.767,00
PS	5.103,00
PF	5.341,00
PX	5.746,00
PA	6.110,00



KRISTALETT200

I Letto con struttura in tubolare tondo cromato o verniciato con rete a doghe in legno per materasso cm.200X200 (materasso escluso).

E Bed with round tubular steel frame chromed or varnished, with wooden slatted base for mattress cm. 200X200 (mattress not included).

F Lit avec structure en métal tubulaire rond chromé ou verni avec sommier à lattes pour matelas cm. 200X200 (matelas pas inclus).

D Bett mit rohre runde verchromten oder lackierten Gestell; Holz-Lattenrost fuer Matratze cm. 200X200 (ohne Matratze).

S Cama con estructura en tubo de acero redondo cromado o pintado; somier con láminas de madera para colchón de cm. 200x200 (colchón no incluido).

cm. 200 x 225 x h 80 • mt. 3.30
in. 78"¾ x 88"½ x h 31"½ • yd. 3.60

COM	4.700,00
L	4.765,00
T	4.842,00
S	4.907,00
Z	4.985,00
K	5.050,00
PS	5.348,00
PF	5.591,00
PX	6.116,00
PA	6.515,00

TUBE - Design Mauro Lipparini



Struttura. La testata e i fianchi laterali sono composti di diverse parti realizzate in legno massello di pioppo (stagionato "naturalmente" per almeno 3 anni) con elementi in multistrato di pioppo e pannello nobilitato; giunzioni a incastro con spine cilindriche. L'imbottitura è ottenuta con una lastra di poliuretano espanso indeformabile con densità di 70 kg/m³ esente da CFC. Testata e fianchi laterali sono rivestiti in cuoio e fissati a una struttura d'acciaio sulla quale è poggiata una rete a doghe in legno.

Base. Piedini in acciaio verniciato a polveri epossidiche in colore nero opaco.

Rivestimento. Disponibile in cuoio; non sfoderabile.

Comodini. In multistrato di faggio curvato in stampo rivestiti in cuoio. Le parti cromate sono in laminato con finitura cromata.

Frame. Headboard and lateral bands are made with different materials: solid poplar heartwood ("naturally" seasoned for at least 3 years) with connecting elements in poplar plywood and melamine coated panels; dap joints with cylindrical dowels. The framework is upholstered with contoured sheets of resilient, CFC-free polyurethane foam with density of 70 kg/m³. Headboard and lateral bands are covered in saddle leather and then are fixed to a metal frame where leans a wooden slatted base.

Base. Supports in steel epoxy powder painted in matt black color.

Covers. Available in saddle leather; non removable covers.

Night tables. In beech plywood curved into a mould and covered in saddle leather. The chromed parts are in laminate with chrome finish.



TUBE00LETT160

I Letto rivestito in cuoio con dettagli cromati con rete a doghe in legno per materasso cm.160X200 (materasso escluso).

E Bed covered in saddle leather with chromed details with wooden slatted base for mattress cm. 160X200 (mattress not included).

F Lit recouvert de cuir épais avec détails chromé avec sommier à lattes pour matelas cm. 160X200 (matelas pas inclus).

D Bett in Leder bezogen mit Vollendungen verchromten; Holz-Lattenrost fuer matratze cm. 160X200 (ohne Matratze).

S Cama tapizada en cuero y detalle cromado; somier con láminas de madera para colchón de cm. 160x200 (colchón no incluido).

CV 5.917,00

CF 5.303,00

CS 4.535,00

cm. 178 x 230 x h 74
in. 70"½ x 90"½ x h 29"½



TUBE00LETT180

I Letto rivestito in cuoio con dettagli cromati con rete a doghe in legno per materasso cm.180X200 (materasso escluso).

E Bed covered in saddle leather with chromed details with wooden slatted base for mattress cm. 180X200 (mattress not included).

F Lit recouvert de cuir épais avec détails chromé avec sommier à lattes pour matelas cm. 180X200 (matelas pas inclus).

D Bett in Leder bezogen mit Vollendungen verchromten; Holz-Lattenrost fuer matratze cm. 180X200 (ohne Matratze).

S Cama tapizada en cuero y detalle cromado; somier con láminas de madera para colchón de cm. 180x200 (colchón no incluido).

CV 6.152,00

CF 5.503,00

CS 4.693,00

cm. 198 x 230 x h 74
in. 78" x 90"½ x h 29"½



TUBE00LETT200

I Letto rivestito in cuoio con dettagli cromati con rete a doghe in legno per materasso cm.200X200 (materasso escluso).

E Bed covered in saddle leather with chromed details with wooden slatted base for mattress cm. 200X200 (mattress not included).

F Lit recouvert de cuir épais avec détails chromé avec sommier à lattes pour matelas cm. 200X200 (matelas pas inclus).

D Bett in Leder bezogen mit Vollendungen verchromten; Holz-Lattenrost fuer matratze cm. 200X200 (ohne Matratze).

S Cama tapizada en cuero y detalle cromado; somier con láminas de madera para colchón de cm. 200x200 (colchón no incluido).

CV 6.639,00

CF 5.931,00

CS 5.044,00

cm. 218 x 230 x h 74
in. 85"½ x 90"½ x h 29"½

TUBE - Design Mauro Lipparini



TUBE00LES160

I Letto rivestito in cuoio con testata estesa a destra o a sinistra e dettagli cromati. Rete a doghe in legno per materasso cm.160X200 (materasso escluso).

E Bed covered in saddle leather with headboard extended on right or left side. Chromed details with wooden slatted base for mattress cm. 160X200 (mattress not included).

F Lit recouvert de cuir epais avec tête étendu à droite ou à gauche et avec détails chromés. Sommier à lattes pour matelas cm. 160X200 (matelas pas inclus).

D Bett in Leder bezogen mit Kofstutze nach rechts oder nach links und Vollendungen verchromten. Holz-Lattenrost fuer matratze cm. 160X200 (ohne Matratze).

S Cama tapizada en cuero con cabezal extendido a la derecha o a la izquierda y con detalle cromado. Somier con láminas de madera para colchón de cm. 160x200 (colchón no incluido).

cm. 240 x 230 x h 74
in. 94"½ x 90"½ x h 29"½

CV 6.632,00
CF 5.929,00
CS 5.049,00



TUBE00LES180

I Letto rivestito in cuoio con testata estesa a destra o a sinistra e dettagli cromati. Rete a doghe in legno per materasso cm.180X200 (materasso escluso).

E Bed covered in saddle leather with headboard extended on right or left side. Chromed details with wooden slatted base for mattress cm. 180X200 (mattress not included).

F Lit recouvert de cuir epais avec tête étendu à droite ou à gauche et avec détails chromés. Sommier à lattes pour matelas cm. 180X200 (matelas pas inclus).

D Bett in Leder bezogen mit Kofstutze nach rechts oder nach links und Vollendungen verchromten. Holz-Lattenrost fuer matratze cm. 180X200 (ohne Matratze).

S Cama tapizada en cuero con cabezal extendido a la derecha o a la izquierda y con detalle cromado. Somier con láminas de madera para colchón de cm. 180x200 (colchón no incluido).

cm. 260 x 230 x h 74
in. 102"½ x 90"½ x h 29"½

CV 6.867,00
CF 6.129,00
CS 5.207,00



TUBE00LES200

I Letto rivestito in cuoio con testata estesa a destra o a sinistra e dettagli cromati. Rete a doghe in legno per materasso cm.200X200 (materasso escluso).

E Bed covered in saddle leather with headboard extended on right or left side. Chromed details and wooden slatted base for mattress cm. 200X200 (mattress not included).

F Lit recouvert de cuir epais avec tête étendu à droite ou à gauche et avec détails chromés. Sommier à lattes pour matelas cm. 200X200 (matelas pas inclus).

D Bett in Leder bezogen mit Kofstutze nach rechts oder nach links und Vollendungen verchromten. Holz-Lattenrost fuer matratze cm. 200X200 (ohne Matratze).

S Cama tapizada en cuero con cabezal extendido a la derecha o a la izquierda y con detalle cromado. Somier con láminas de madera para colchón de cm. 200x200 (colchón no incluido).

cm. 280 x 230 x h 74
in. 110"½ x 90"½ x h 29"½

CV 7.356,00
CF 6.558,00
CS 5.560,00



TUBE00LEDO160

I Letto rivestito in cuoio con testata estesa a destra e a sinistra e dettagli cromati. Rete a doghe in legno per materasso cm.160X200 (materasso escluso).

E Bed covered in saddle leather with headboard extended on right and left side. Chromed details with wooden slatted base for mattress cm. 160X200 (mattress not included).

F Lit recouvert de cuir epais avec tête étendu à droite et à gauche et avec détails chromés. Sommier à lattes pour matelas cm. 160X200 (matelas pas inclus).

D Bett in Leder bezogen mit Kofstutze nach rechts und nach links und Vollendungen verchromten. Holz-Lattenrost fuer matratze cm. 160X200 (ohne Matratze).

S Cama tapizada en cuero con cabezal extendido a la derecha y a la izquierda y con detalle cromado. Somier con láminas de madera para colchón de cm. 160x200 (colchón no incluido).

cm. 302.5 x 230 x h 74
in. 119"½ x 90"½ x h 29"½

CV 7.341,00
CF 6.548,00
CS 5.557,00



TUBE00LEDO180

I Letto rivestito in cuoio con testata estesa a destra e a sinistra e dettagli cromati. Rete a doghe in legno per materasso cm.180X200 (materasso escluso).

E Bed covered in saddle leather with headboard extended on right and left side. Chromed details with wooden slatted base for mattress cm. 180X200 (mattress not included).

F Lit recouvert de cuir epais avec tête étendu à droite et à gauche et avec détails chromés. Sommier à lattes pour matelas cm. 180X200 (matelas pas inclus).

D Bett in Leder bezogen mit Kofstutze nach rechts und nach links und Vollendungen verchromten. Holz-Lattenrost fuer matratze cm. 180X200 (ohne Matratze).

S Cama tapizada en cuero con cabezal extendido a la derecha y a la izquierda y con detalle cromado. Somier con láminas de madera para colchón de cm. 180x200 (colchón no incluido).

cm. 322.5 x 230 x h 74
in. 127" x 90"½ x h 29"½

CV 7.576,00
CF 6.749,00
CS 5.714,00

TUBE - Design Mauro Lipparini



TUBE00LEDO200

I Letto rivestito in cuoio con testata estesa a destra e a sinistra e dettagli cromati. Rete a doghe in legno per materasso cm.200X200 (materasso escluso).
 E Bed covered in saddle leather with headboard extended on right and left side. Chromed details and wooden slatted base for mattress cm. 200X200 (mattress not included).
 F Lit recouvert de cuir epais avec tête étendu à droite et à gauche et avec détails chromés. Sommier à lattes pour matelas cm. 200X200 (matelas pas inclus).
 D Bett in Leder bezogen mit Köpfstutze nach rechts und nach links und Vollendungen verchromten. Holz-Lattenrost fuer matratze cm. 200X200 (ohne Matratze).
 S Cama tapizada en cuero con cabezal extendido a la derecha y a la izquierda y con detalle cromado. Somier con láminas de madera para colchón de cm. 200x200 (colchón no incluido).

CV 8.063,00
 CF 7.175,00
 CS 6.066,00

cm. 342.5 x 230 x h 74
 in. 134¹/₂ x 90¹/₂ x h 29¹/₂

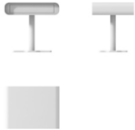

TUBE00COMODIN

I Comodino rivestito in cuoio e base cromata.
 E Night table covered in saddle leather and chromed base.
 F Chevet recouvert de cuir epais avec pietement chromé.
 D Nachttisch in Leder bezogen mit verchromtem Fuss.
 S Mesita de noche tapizada en cuero y pata cromada.

CV 1.532,00
 CF 1.479,00
 CS 1.414,00

cm. 50.5 x 38 x h 45
 in. 19¹/₂ x 15" x h 17¹/₂



TUBE00COOV061

I Contenitore basso ovale rivestito in cuoio.
 E Oval low storage unit covered in saddle leather.
 F Oval element de rangement bas recouvert de cuir epais.
 D Oval Unterschränkchen in Leder bezogen.
 S Contenedor oval bajo tapizado en cuero.

CV 1.785,00
 CF 1.629,00
 CS 1.435,00

cm. 61 x 55.5 x h 27
 in. 24" x 21¹/₂ x h 10¹/₂



TUBE00COOV110

I Contenitore basso ovale rivestito in cuoio.
 E Oval low storage unit covered in saddle leather.
 F Oval element de rangement bas recouvert de cuir epais.
 D Oval Unterschränkchen in Leder bezogen.
 S Contenedor oval bajo tapizado en cuero.

CV 2.183,00
 CF 1.949,00
 CS 1.657,00

cm. 110.5 x 55.5 x h 27
 in. 43¹/₂ x 21¹/₂ x h 10¹/₂

TUDOR - Design Alessandro Dubini



Struttura. La testata e i fianchi laterali sono in legno massello di pioppo (stagionato "naturalmente" per almeno 3 anni) con elementi in multistrato di pioppo e pannelli di nobilitato; giunzioni a incastro con spine cilindriche. L'imbottitura è ottenuta con lastre di poliuretano espanso indeformabile con densità di 30÷75 kg/m³ esente da CFC ricoperto da ovatta poliestere e vellutino accoppiato. Testata e fianchi laterali sono fissati a una struttura d'acciaio sulla quale è poggiata una rete a doghe in legno.

Base. Piedini in acciaio verniciato a polveri epossidiche in colore nero opaco.

Rivestimento. Disponibile in tessuto e pelle; non sfoderabile.

Comodini. In pannello nobilitato rivestito in cuoio. Base in tubolare d'acciaio cromato.

Frame. Headboard and lateral bands are in solid poplar heartwood ("naturally" seasoned for at least 3 years) with connecting elements in poplar plywood and chipboard panels; dap joints with cylindrical dowels. The framework is upholstered with contoured sheets of resilient, CFC-free polyurethane foam with density of 30÷75 kg/m³ covered by polyester wadding and bonded plush. Headboard and lateral bands are fixed to a metal frame where leans a wooden slatted base.

Base. Supports in steel epoxy powder painted in matt black color.

Covers. Available in fabric or leather; non removable covers.

Night tables. In melamine coated panel covered in saddle leather. Chromed tubular steel base.



TUDOROLETT160

I Letto imbottito con rete a doghe in legno per materasso cm. 160X200 (materasso escluso).

E Upholstered bed with wooden slatted base for mattress cm. 160X200 (mattress not included).

F Lit rembourré avec sommier à lattes pour matelas cm. 160X200 (matelas pas inclus).

D Gepolstertes Bett mit Holz-Lattenrost fuer Matratze cm. 160X200 (ohne Matratze).

S Cama rellena con somier con láminas de madera para colchón de cm. 160x200 (colchón no incluido).

COM	5.264,00
L	5.449,00
T	5.669,00
S	5.852,00
Z	6.074,00
K	6.257,00
PS	6.877,00
PF	7.526,00
PX	8.564,00
PA	9.538,00



cm. 160 x 231 x h 108 • mt. 9.35
in. 63" x 91" x h 42"½ • yd. 10.25



TUDOROLETT180

I Letto imbottito con rete a doghe in legno per materasso cm. 180X200 (materasso escluso).

E Upholstered bed with wooden slatted base for mattress cm. 180X200 (mattress not included).

F Lit rembourré avec sommier à lattes pour matelas cm. 180X200 (matelas pas inclus).

D Gepolstertes Bett mit Holz-Lattenrost fuer Matratze cm. 180X200 (ohne Matratze).

S Cama rellena con somier con láminas de madera para colchón de cm. 180x200 (colchón no incluido).

COM	5.570,00
L	5.775,00
T	6.022,00
S	6.227,00
Z	6.475,00
K	6.680,00
PS	7.404,00
PF	8.139,00
PX	9.315,00
PA	10.418,00



cm. 180 x 231 x h 108 • mt. 10.45
in. 70"½ x 91" x h 42"½ • yd. 11.45



TUDOROLETT200

I Letto imbottito con rete a doghe in legno per materasso cm. 200X200 (materasso escluso).
 E Upholstered bed with wooden slatted base for mattress cm. 200X200 (mattress not included).
 F Lit rembourré avec sommier à lattes pour matelas cm. 200X200 (matelas pas inclus).
 D Gepolstertes Bett mit Holz-Lattenrost fuer Matratze cm. 200X200 (ohne Matratze).
 S Cama rellena con somier con láminas de madera para colchón de cm. 200x200 (colchón no incluido).

COM	5.972,00
L	6.202,00
T	6.477,00
S	6.706,00
Z	6.981,00
K	7.211,00
PS	8.026,00
PF	8.848,00
PX	10.163,00
PA	11.396,00



cm. 200 x 231 x h 108 • mt. 11.65
 in. 78³/₄ x 91¹/₂ x h 42¹/₂ • yd. 12.75



TUDOROCOMODIN

I Comodino rivestito in cuoio e base cromata nera.
 E Night table covered in saddle leather and black chromed base.
 F Chevet recouvert de cuir epais avec pietement chrome noire.
 D Nachttisch in Leder bezogen mit Schwarz verchromtem Fuss.
 S Mesita de noche tapizada en cuero y pata cromada negra.

CV	1.591,00
CF	1.540,00
CS	1.475,00

cm. 40.5 x 40 x h 46
 in. 16¹/₂ x 15³/₄ x h 18³/₈

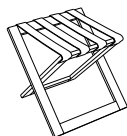

OPTIONLUGRACK

I Porta-valigie laccato in colore RAL a scelta del cliente. Cinghie in cuoio.
 E Luggage rack lacquered in RAL color chosen by the customer. Saddle leather straps
 F Porte-bagages laqué couleur RAL choisi par le client. Lanières de cuir épais.
 D Gepäckträger lackiert in RAL-Farbe nach Wunsch des Kunden. Rindledergürtel.
 S Portaequipajes lacado en color RAL elegido por el cliente. Correas de cuero.

572,00

cm. 54 x 50 x h 50
 in. 21¹/₄ x 19³/₈ x h 19³/₈

